

- Build your buildings from 1/4" Plywood
- Decorate with purchased trims or make your own trims
- Add commercial windows and doors or build your own from 1/8" thick hardwood or balsa. Garden Towns Doors and Windows patterns sold separately.
- Porch rail is also built from 1/8" thick hardwood or balsa
- Optional: Add lights, using manufacturers instructions

Scaled and easy to read patterns and instructions.

2 Story Flat Roof

Yard and Garden Buildings
 Compatible with Garden Railroads
 or a delight for any child's collection

Overall Dimensions

Foundation: 10" x 15"
 Building: 10" x 10-1/2"
 Walls: 10" high with 12-1/2" Front

Patterns include
 Building:

Walls, Roof, Foundation,
 Porch with optional rail and Signs

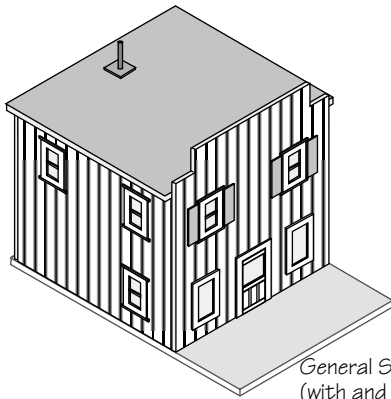

General Store
 (with and without porch)

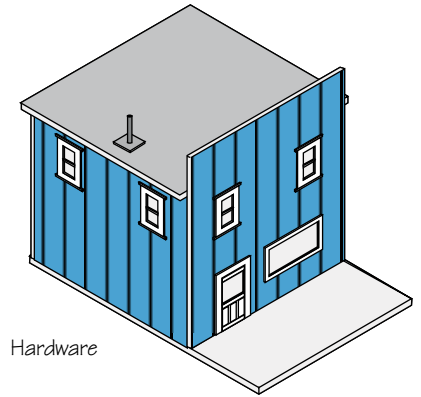
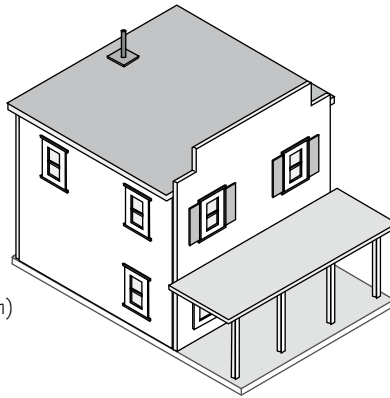

Hardware

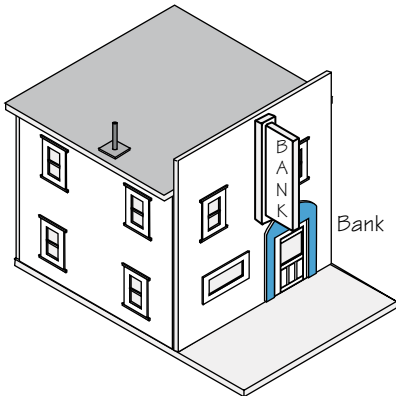

Bank

There are six buildings illustrated with specific walls. Walls shown are not inclusive. You can also "mix and match" the wall arrangements to design your own building. Foundation provides space for plain sidewalk or porch addition.

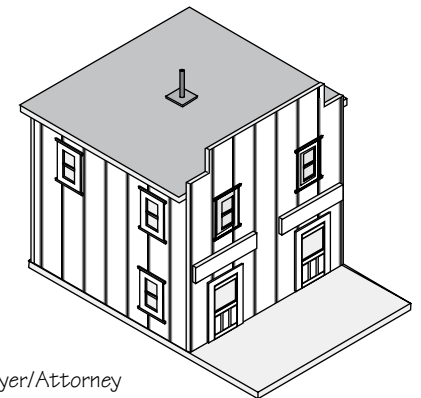

Assayer/Attorney

Choose between two types of fronts: Plain or Stepped Top Fronts are interchangeable with door and window placements.

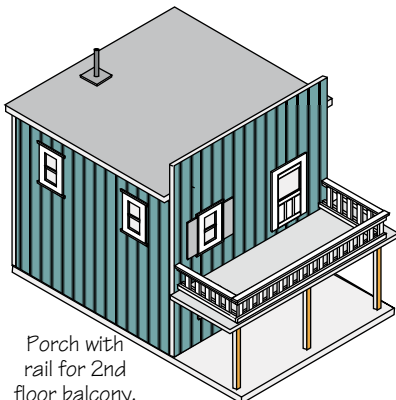

Porch with rail for 2nd floor balcony.

Betty Jeans
 Dresses

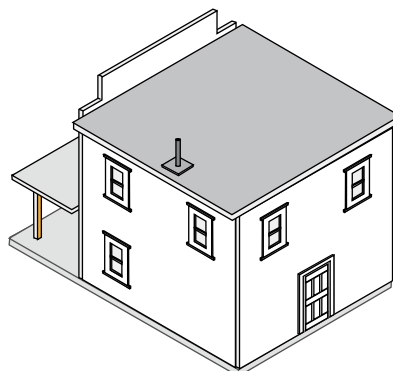

One of 6 back views

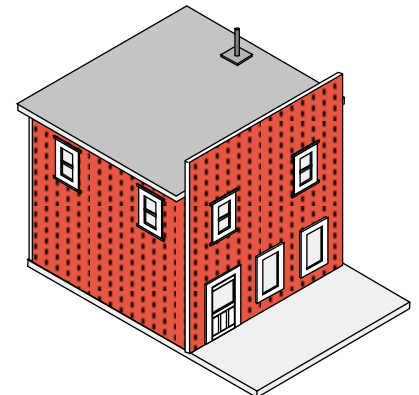

Grocery

Introduction

Thank you for purchasing the Garden Town pattern. As a background, the Garden Town houses and buildings were inspired by the Garden Scale Railroads. We wanted to build small towns as backdrops for the trains. After building several prototypes, we discovered that they are actually fun to make. They don't even have to have a railroad to accompany. Depending on your choices, each of the houses can be different. They can be an addition to your flower garden. Or a backdrop toy for a child. If you are building yours for outside display, do keep in mind the elements. Houses will have to be sealed with polyurethane or varnish to minimize weather damage.

Please take a few minutes and go over the Steps to Building Your Building before you begin.

We hope you enjoy your project!

Table of Contents

Before You Begin	
Steps to Building Your Building	3
Tools and Supplies	
General	4
Door and Window Requirements	5
Working With Small Items	6
Building and Porch Layout	7
Top Rail for Porch Layout	
2 Signs to Make	
Frame	8
Planning the Building	
Buildings to Choose From	9
Walls -Door and Window Placement	
Front Walls	12
Side Walls	13
Back Walls	14
Porches -	
Patterns and Assembly	15
Top Rail Patterns and Assembly	18
House Patterns	23
Assembly	
Walls	25
Building	27

Planning the Building - Decide which building you will build. If you use one of the buildings we have illustrated, we have indicated which walls to use.

Planning the Walls section is to be used as a guide for placement of doors and windows. Although our illustrations show the dimensions for Garden Town Doors and Windows, you can use the illustrations as guides, adjust your measurements and install purchased doors and windows.

Porches - Optional

Three or four post porches to choose from, depending on where the door is placed.

Doors and Windows

Opening Type Doors -If you use commercially purchased doors, you will have to cut into the building frame. Our illustrations show how to make the opening. The size of the opening will depend upon the doors and windows you purchase and the instructions which come with them.

Non-Opening Doors-Such as Kiva Design Garden Town Doors and Windows, which you build yourself, you can build a simple "box frame" for the building. The window openings will be above the frame and the 1/8" thick doors will fit into the 1/4" walls.

Keep in mind:

A building should have a minimum of 2 exits (doors). If the set up is duplex, each unit should have 2 doors. An example is the Shoe/Western Union Building. Door and window openings will need to be at least 1" from the sides and 1" from the roofline so they don't interfere with the building frame behind the walls.

Before You Begin

Tools and Supplies -

Layout

Record how much 1/4" Plywood you will need to build the building you want.

Door and Window Requirements"

Record how many you will need. Decide if you want to purchase or build. Record supplies you will need.

Frame

Record how many feet of 1" Furring Strip you will need

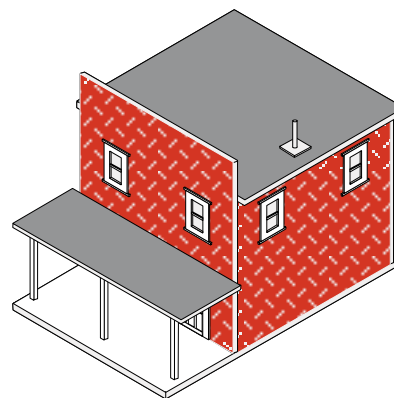

Optional - Items to consider from the hobby store:

Lights - Add Lights according to manufacturers instructions. We suggest that you use screws instead of nails when attaching the roof to allow future access to the wiring and bulb.

You can buy scaled wood shingles for your roof as well as assorted other detailed items. You can make your own signs with help from a stencil or the stick-on letters and numbers available.

Ready to Build

Determine which patterns you will need:

- 1- Building Front (Straight or Stepped)
- 2- Side Walls
- 1- End Wall
- 1 -Roof
- Porch, as required

- Cut out all wood, according to Pattern dimensions.
- Cut Furring Strips for frame -
see Tools and Supplies-Frame
- Measure and cut out door and window openings from the walls, as needed (*see Assembly - Walls*).
- Sand off any rough edges.
- Optional: Paint or stain the walls. Dings can be touched up later. You may prefer to do this step after assembly is completed.
- If used, assemble the Porch, per individual instructions.

- Assemble the building (*see Assembly - Building*).

If you are placing your house outside, be sure to protect it with a good seal of polyurethane or varnish.

Window and Door Placement

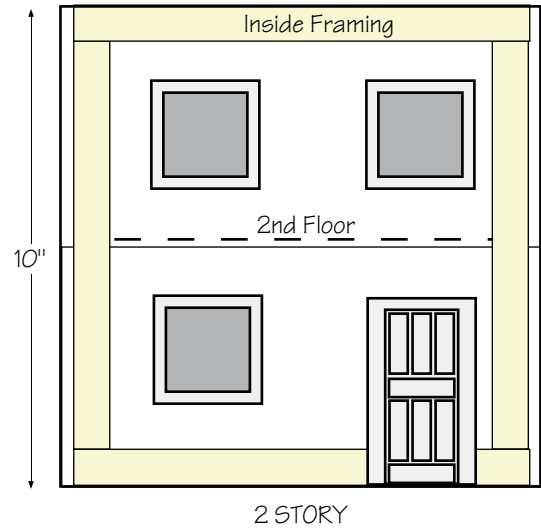
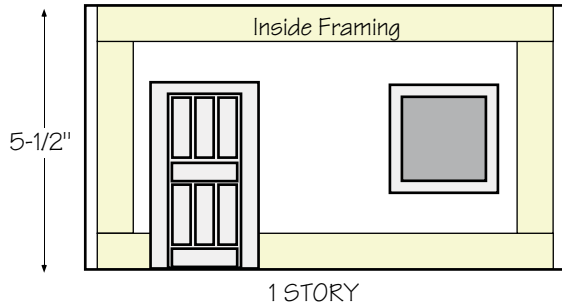

- Buildings and porches are constructed from 1/4" thick plywood
- Framing for the walls is made from 1" Furring strips (nominally 3/4" thick)
- Garden Town Doors and Windows are made from 1/8" thick Balsa wood or Hardwood and plastic glazing for the window panes
- Windows and doors have to be at least 1" from sides and top (to clear inside building frame)
- Doors are placed at floorline
- Floorline on 2nd floor will be 5-1/8" from bottom of wall
- Windows are placed with tops level with doors (some exceptions)

For a few hints to experiment with on the wall finishes, see "Simulated Patterns" in our free **Food for Thought** brochure.

Tools Needed for Building

- Saw (for cutting small wood pieces, a jig saw or a coping saw)
- Hammer or Stapler or Air Gun
- Clamps
- T-Square
- Level
- Ruler and Pencil (We prefer see-thru rulers with grids for the small pieces)

If you are making Doors & Windows from Balsa wood

- X-ACTO knife and metal ruler for guide
- Optional:**
- Ruler - the plastic see-thru kind with 1/8" grid is a plus.
- Balsa stripper - This little gizmo is used for making various widths of uniform strips from balsa wood. You can set it to cut small widths, (1/8", 1/4", 1/2" etc.) It saves a lot of time if you prefer to cut your own strips.
- Of course you can buy the strips "ready made" at a higher price.
- Clamps (small) - The X-ACTO clamps for small pieces are very handy.

Supplies Needed - General

- 5/8" Staples or Brads
- 2" Finishing Nails
- Wood Glue
- Paint or Stain - We suggest the water based Acrylic Paints found in a multitude of colors in arts and crafts stores.
- Sealer - Water Base Varnish found with the acrylic paints or a sealer such as polyurethane.
- Optional: Caulking for sealing porches, roofs, etc.

	1	8'	96"
1" x 1" x 8'	2	16'	192"
Furring	3	24'	288"
Strips	4	32'	384"
needed	5	40'	480"

Specific Building Supplies
Medium Town Building

For Details
 See Page

1/4" Plywood (No. of Sheets)	48" x 21" (1) 4' x 4'	7
1" x 1" Furring Strips (nominally 3/4" x 3/4")		
Total	106"	8
Purchased Doors & Windows or 1/8" Balsa or Hardwood (4" x 36" Boards)		5
Doors & Windows		5
Depends on building	2 or 3	
Optional Top Rail for Porch (or 3/8" x 18" strips and 1/4" x 90" strips)	1	7
Optional Bars for Window #4 Depends on number**		
Clear Plastic Glazing for Windows		5
8" x 10" Sheet	1	
1/8" Wood Dowel		27
For Rooftop Pipe	1"	
For Optional Bars for Window # 4 Depends on number **		

**See Door & Window Series Page 58

Optional Small Parts Frame - Page 6
 1/4" Plywood - No extra needed
 1" x 1" Furring Strips - Add 52"

Doors and Windows

Option: You can purchase ready-made doors and windows which actually open. For example, Grandt Line carries a well made and ready to paint plastic selection for Scale 1:24.

or
 you can make your own (Garden Towns Doors and Windows Patterns by Kiva Design) These doors and windows are also 1/24 scale, but are a little larger overall for ease in building. They are non-opening (no hinges).

The following are samples represented for the scaled dimensions.

Buildings are illustrated with the Kiva Design Samples. Neither of the samples are inclusive all all doors and windows available.

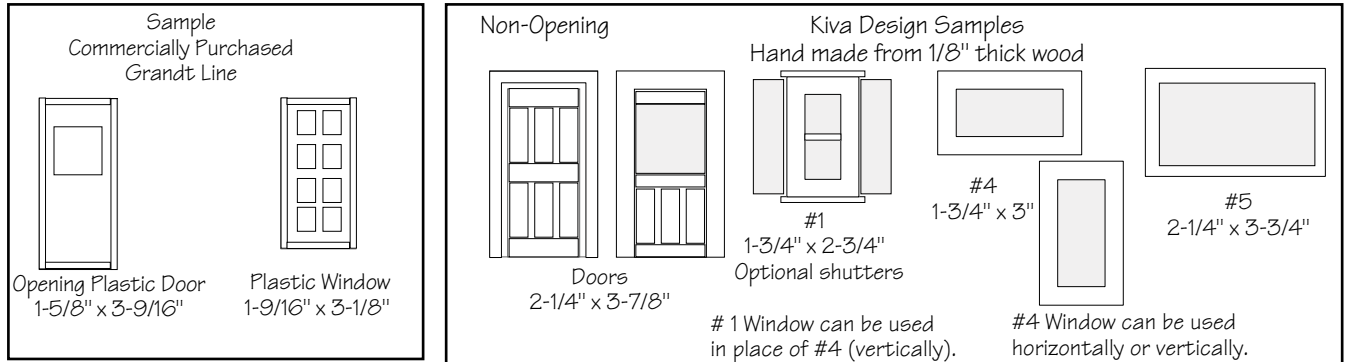

- Purchased Doors and Windows as required
- OR
- 1/8" Balsa wood or Hardwood for Doors and Windows:
 4" x 36"
 (common size at hobby shops)

Building	Doors and Windows required for buildings illustrated				1/8" thick Balsa Wood or Hardwood Number of 4" x 36" boards needed for buildings shown*
	Doors	Windows			
		#1	#4	#5	
General Store	2	10	2	-	3
Bank	2	11	1	-	3
Assayer/Attorney	4	10	-	-	3
Grocery	2	9	2	-	2
Hardware	2	9	-	1	2
Betty Jeans Dresses	3	8	-	1	2

*Doors and windows shown for the building can be made from the number of boards indicated. However, "we" personally always buy one extra board in the unlikely event that we'll need it to redo our "errors". Left-overs are saved for the next project.

- Clear Plastic for Windows
 8" x 10" Sheet
 (from hobby shop framing area)

Assembly Frame for Small Items

Patterns

Cut from plywood -1/4" thick or any scrap

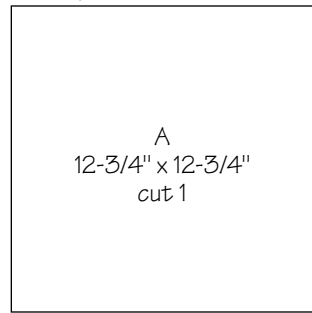

Cut from 1 x 1 Framing (nominally 3/4" x 3/4")

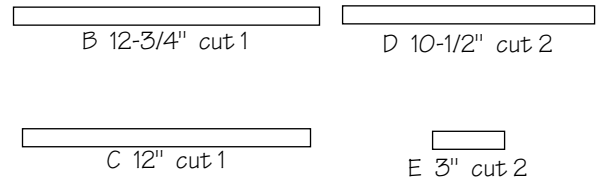

Assembly

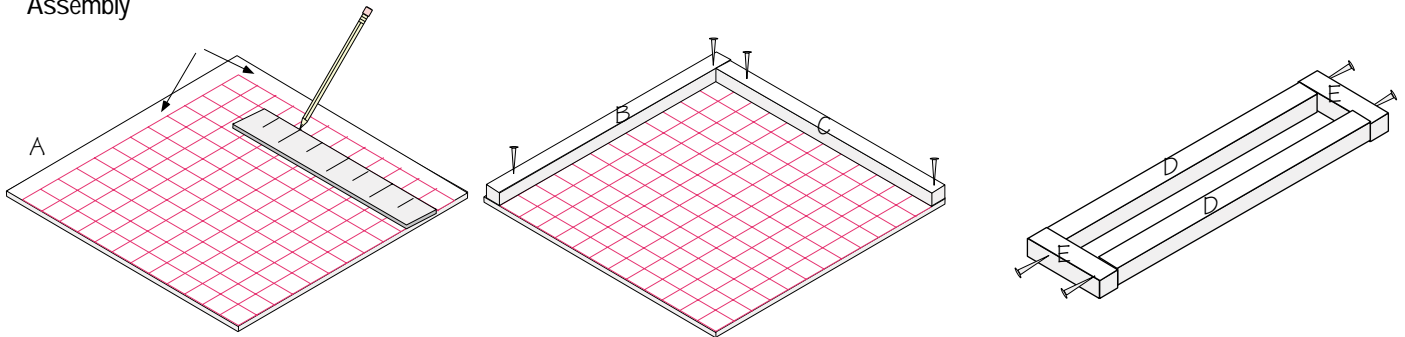

1. Using pencil or pen and ruler, draw lines 3/4" inside of 2 adjacent sides of the base. The frame will be placed in this area. From those 2 lines, draw lines at 1" intervals, forming a 1" grid.

2. Nail and glue frame parts B and C in place, as shown, maintaining a square corner.

3. Using glue and nails, assemble the frame "push bar", as shown. Again, make sure that the corners are square.

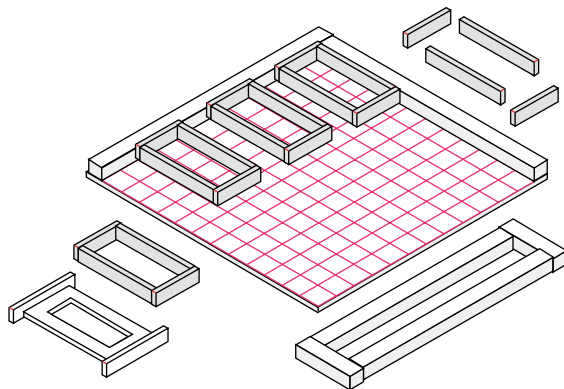

4. Glue parts and assemble inside the frame. The grid will help you keep the pieces straight. You can assemble several "like" pieces at one time.

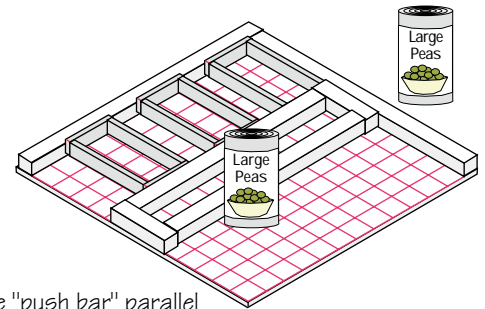

5. Keep the "push bar" parallel to side C and push it firmly against the assembled parts. Use anything with weight to hold the push bar in place until parts are dry. Canned goods you didn't want for dinner work well.

Trimming 1/8" Balsa wood or hardwood

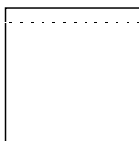

1. Using ruler and pencil make a line 1/8" from the inside edge to be mitered

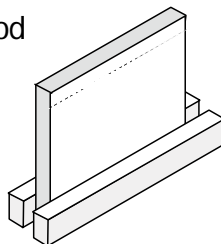

2 Stabilize the piece to be mitered with a clamp or other means

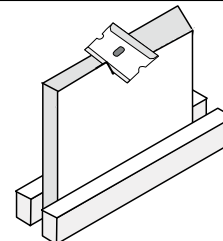

3. With blade, carefully trim from the top outside to the marked line. Alternately, the piece can planed or sanded.

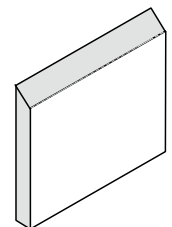

Trimmed on the inside

Layout for Building and Porch
 Cut from 1/4" Plywood
 21" X 48"

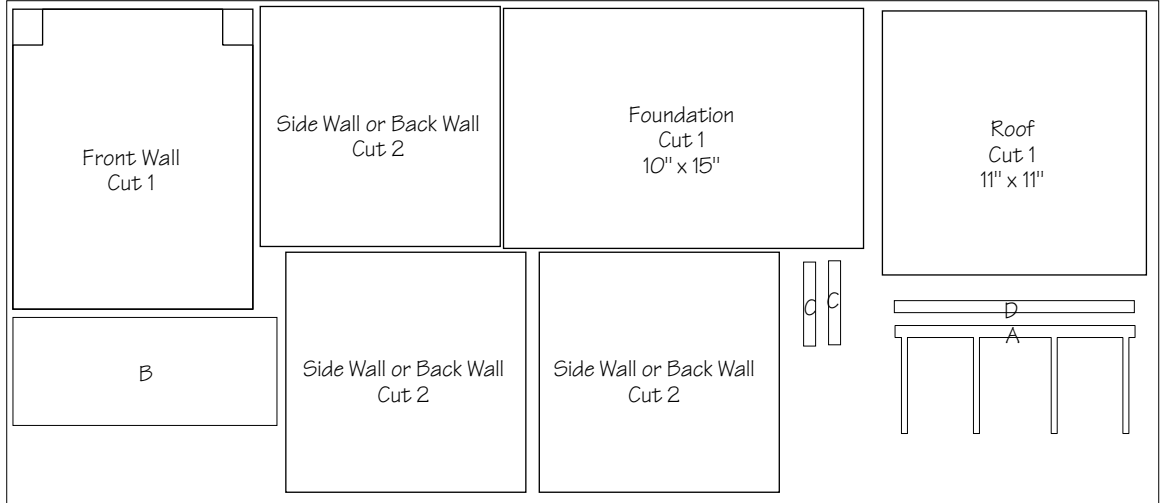

Layout - Top Rail for roof
 Cut from 1/8" Thick Balsa Wood or Hardwood
 4" X 10"

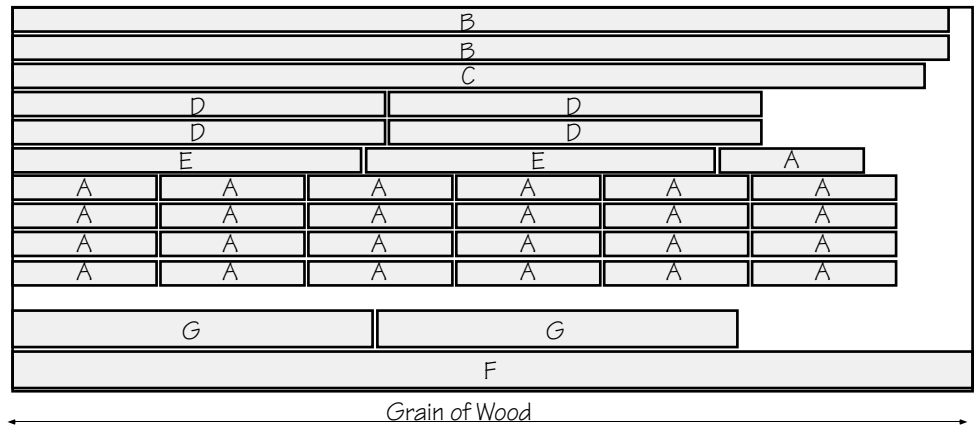

You may wish to purchase "ready made" strips
 90" - 1/4" Strips
 18" - 3/8" Strips

2 Signs you can make from scrap wood.
 Make from 1/4" Plywood or 1/8" Hardwood

We suggest purchasing the stick-on letters found at hobby store.

Sign # 1

**Caleb's
 General Store**

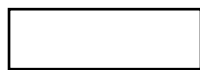
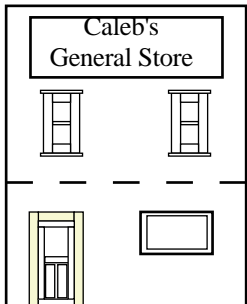

Paint sign and let dry.
 Add letters and seal entire sign with polyurethane.
 Lightly nail and glue in place.

2-1/2" x 8"

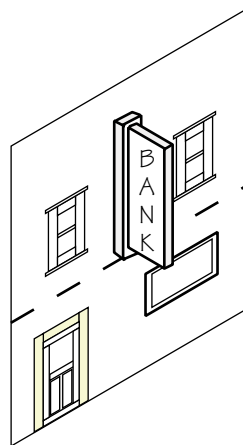

Sign # 2

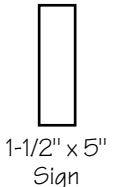
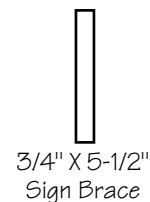

Attach sign to brace with glue. Let dry.
 Paint sign and brace and let dry.
 Add letters to sign.
 Seal entire sign with polyurethane.
 Lightly nail and glue through brace into wall.

The Frame

You will need to build a frame for which to attach the walls.

Non-Opening Doors

If your building will have doors which do not physically open, you can build a simple box for your wall braces. The windows and doors will fit into the walls.

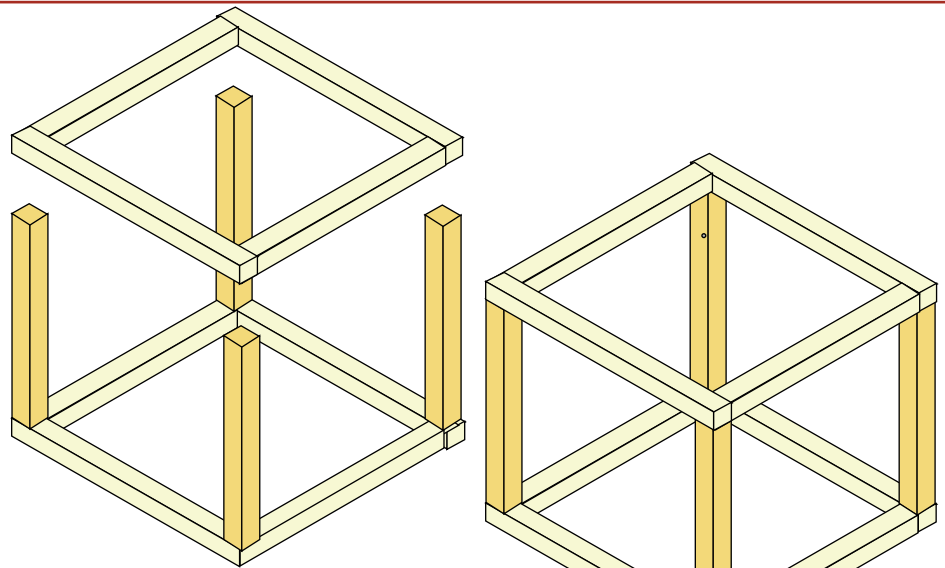

Build this frame if you are using Garden Town Doors and Windows

Opening Doors

If your house will have doors which do physically open, you will be cutting openings in the bottom frame.

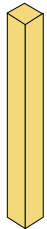

Vertical Braces for 2 Story Houses are 8-1/2"

Build this frame if you are using purchased doors which open

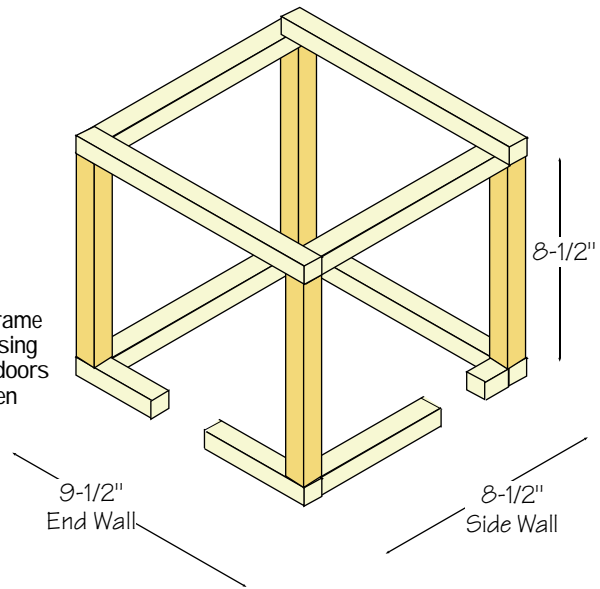

•1" Furring Strips for Framing 2 Story	
4 @ 9-1/2	38"
4 @ 8-1/2"	34"
4 @ 8-1/2"	34"
Total	106"

Conversion Inches = Feet	
12"	1'
24"	2'
36"	3'
48"	4'
60"	5'
72"	6'
84"	7'
96"	8'
108"	9'
120"	10'
132"	11'
144"	12'
156"	13'
168"	14'
180"	15'
192"	16'

GENERAL STORE

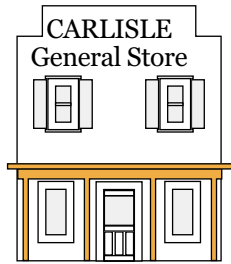
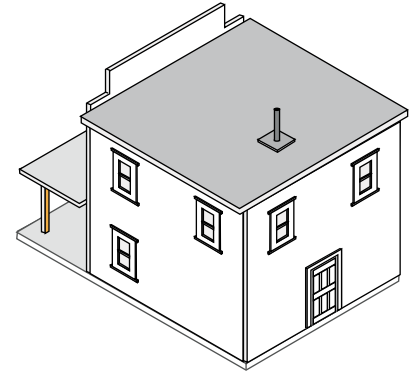
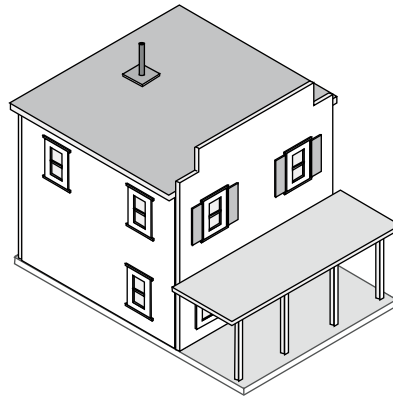
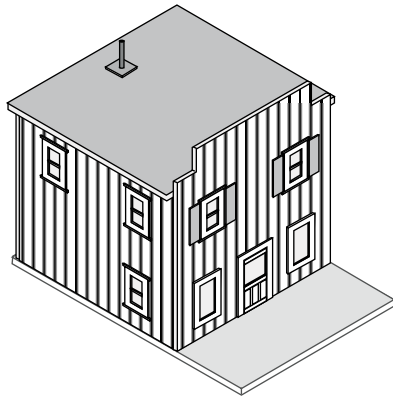

Walls shown for General Store

CARLISLE General Store			
S3	F4	S2	B6

BANK

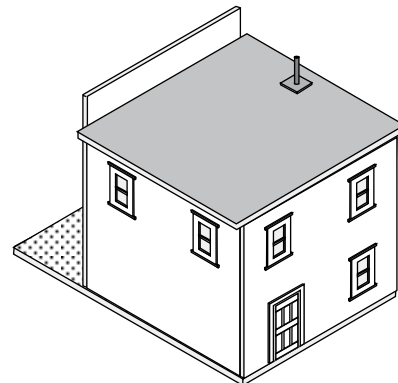
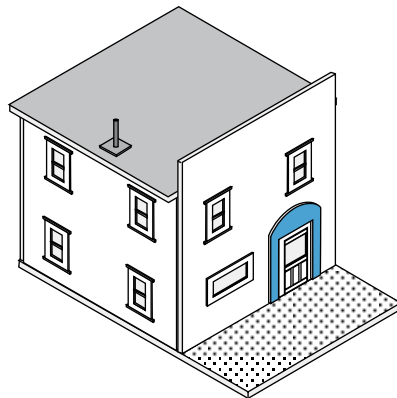

If you want some of your bank windows to have bars, use Window # 4 installed vertically and the bars on page WA4-1.

FIRST BANK			
S4	F3	S1	B4

ASSAYER / ATTORNEY

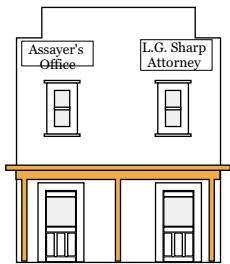
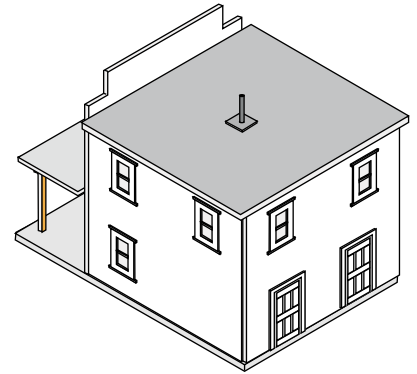
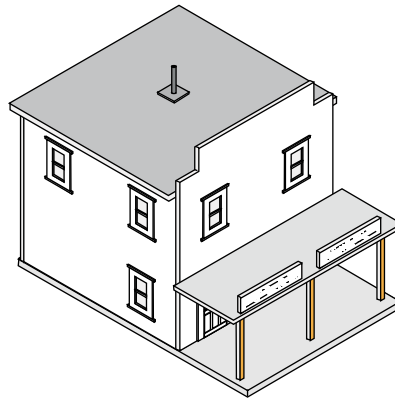
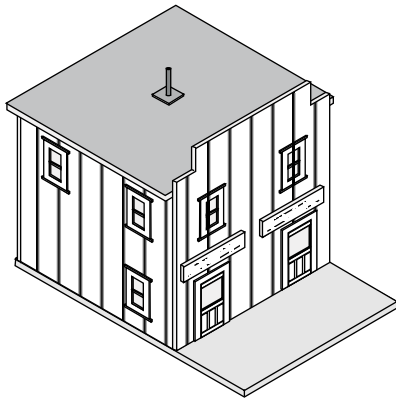

Walls shown for Assayer/Attorney

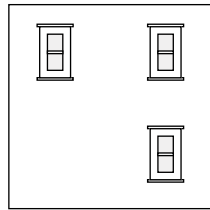

S3

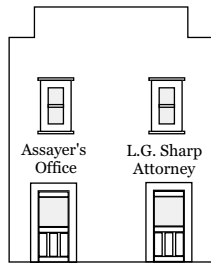

F1

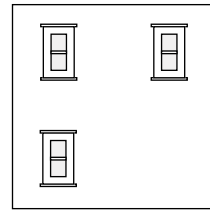

S2

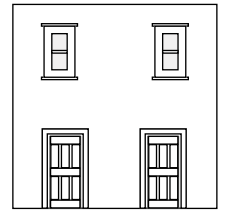

B1

GROCERY

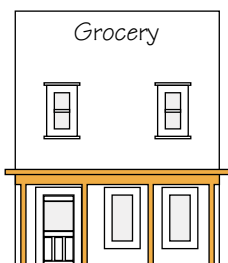
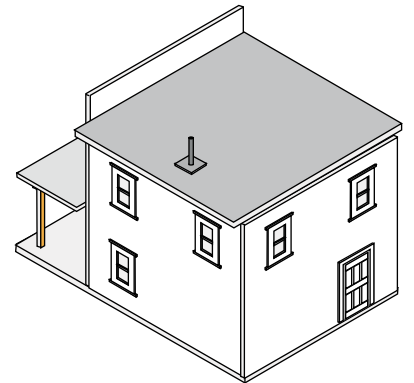
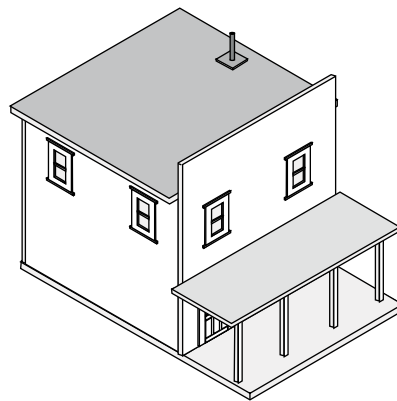
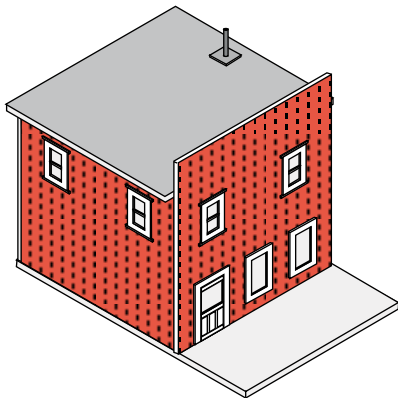

Walls shown for Grocery

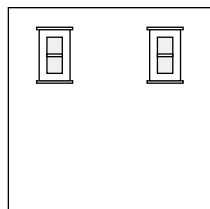

S1

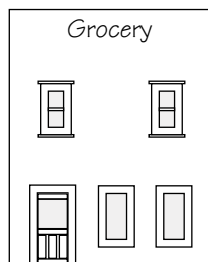

F5

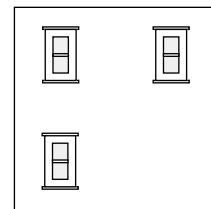

S2

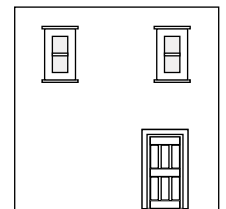

B3

HARDWARE

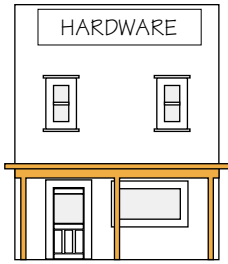
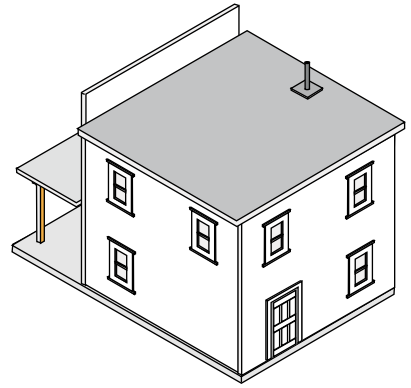
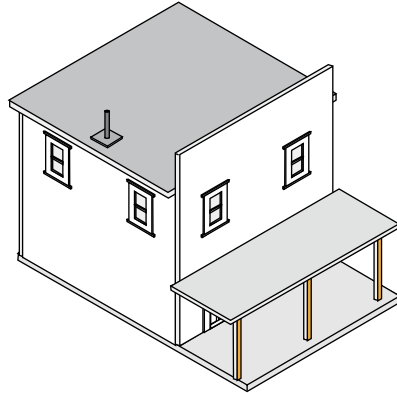
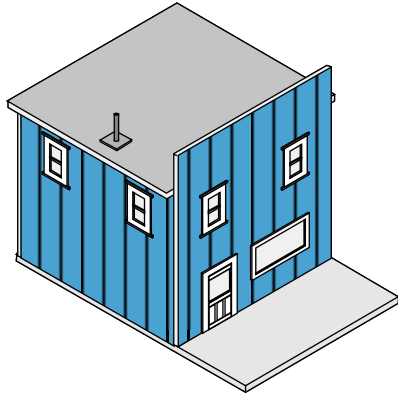

Walls shown for
 Hardware Store

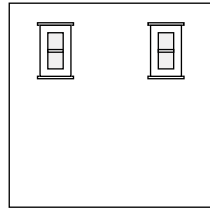

S1

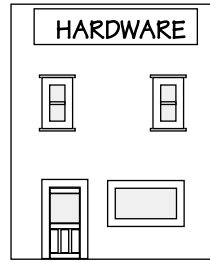

F3

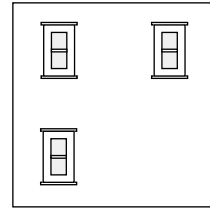

S2

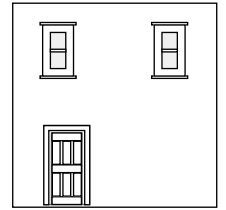

B2

BETTY JEANS DRESSES

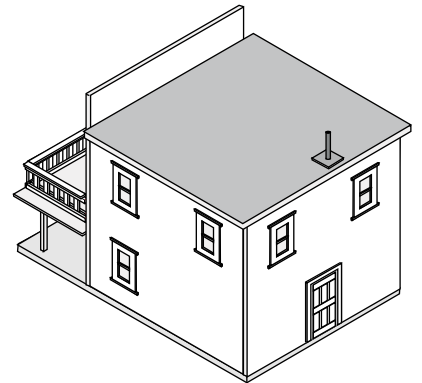
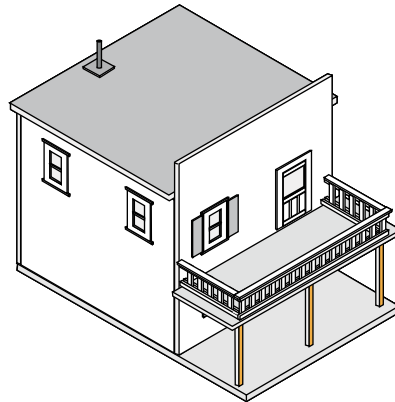
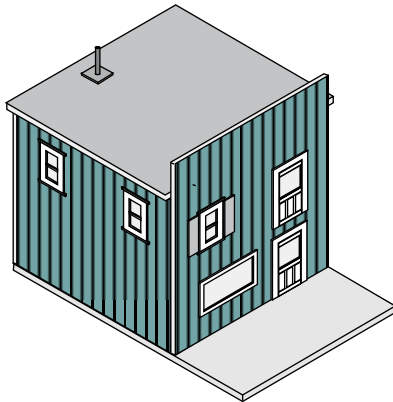

Walls shown for
 Betty Jean's Dresses

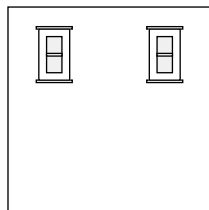

S1

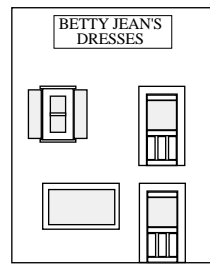

F7

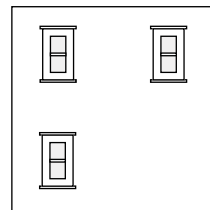

S2

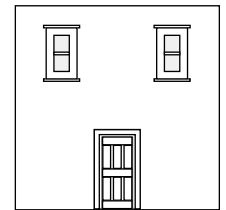

B6

Choose between the two types of fronts (Plain or Stepped).
 Both are the same overall size. The door and window placements will be the same.

Front Walls

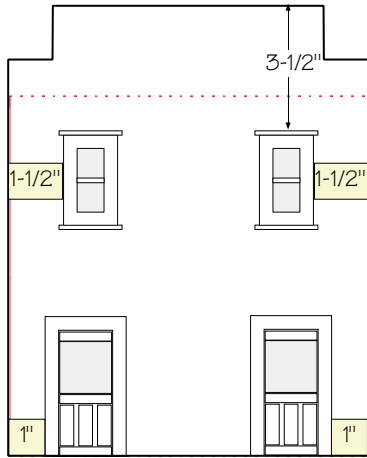

F1

Shown: Window # 1
 Can Use # 4

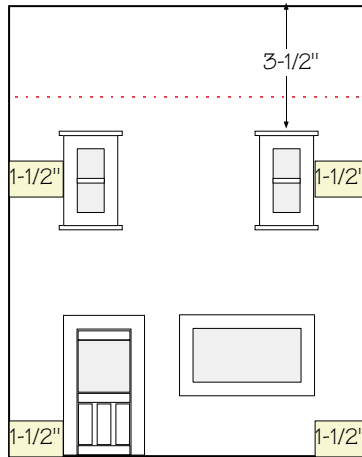

F2

Shown: Window # 1 up
 and Window # 5 down
 Can Use # 4 either place

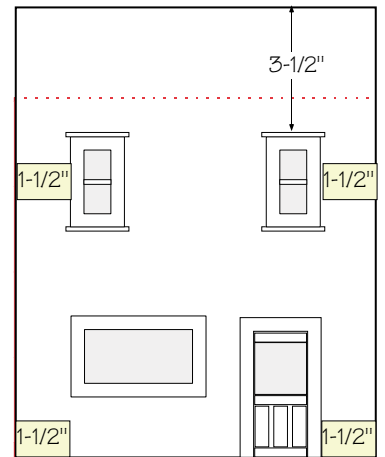

F3

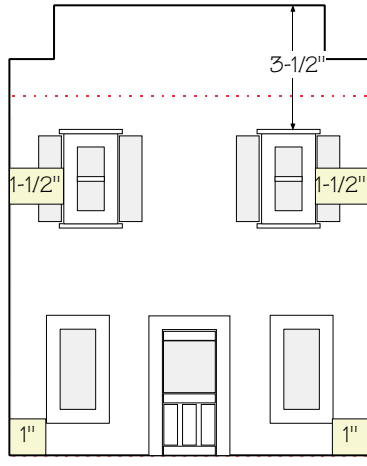

F4

Shown: Window # 1 up
 and Window # 4 down
 Can Use either window both places

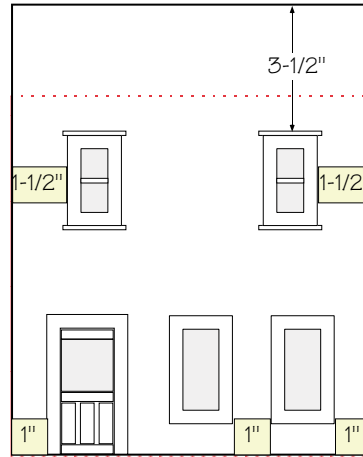

F5

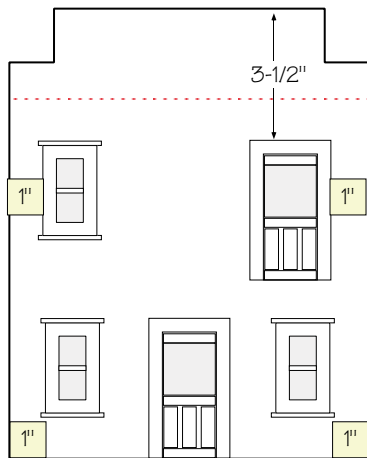

F6

Shown: Window # 1
 Can Use Window # 4

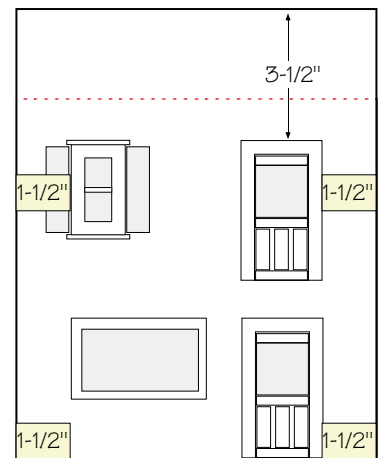

F7

Shown: Window # 1 up
 and Window # 5 down
 Can Use Window # 4 both places

Side walls and Back Walls are interchangeable

Side Walls

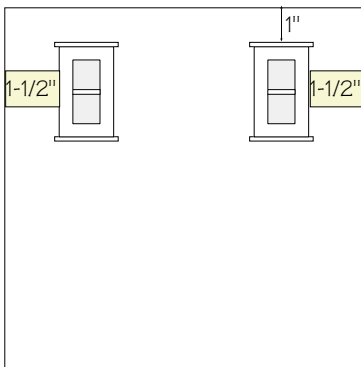

S1
Shown: Window # 1
Can Use # 4

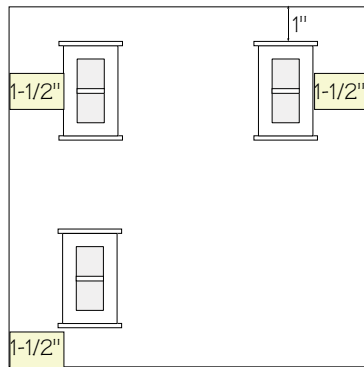

S2
Shown: Window # 1
Can Use # 4

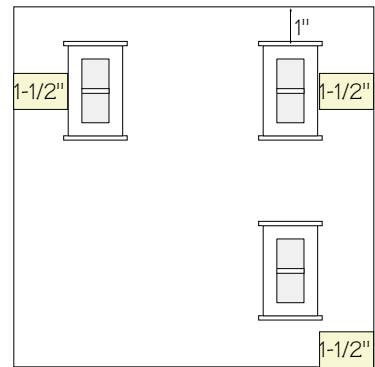

S3

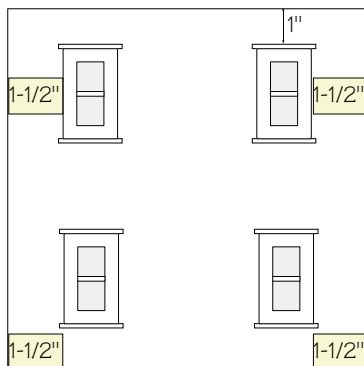

S4
Shown: Window # 1
Can Use # 4

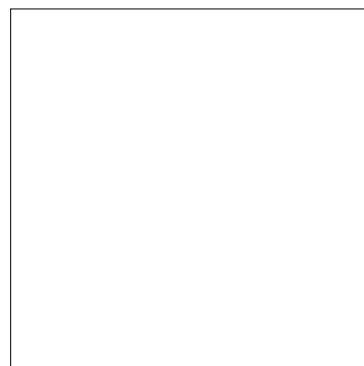

S5
Use blank wall if you want
to place against another building

Side walls and Back Walls are interchangeable

Back Walls

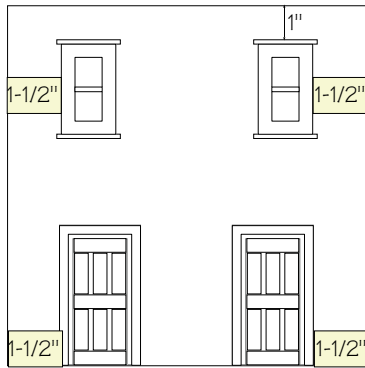

B1

Shown: Window # 1
 Can Use # 4

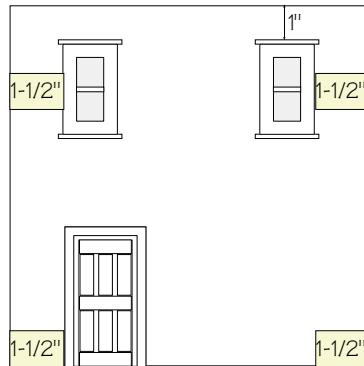

B2

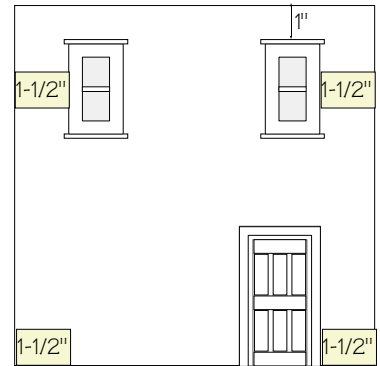

B3

Shown: Window # 1
 Can Use # 4

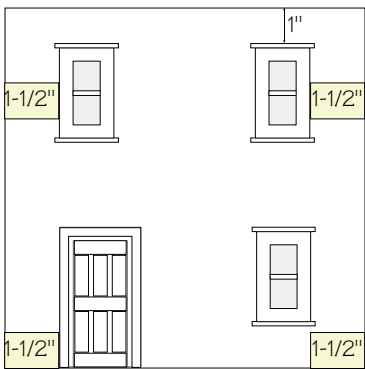

B4

Shown: Window # 1
 Can Use # 4

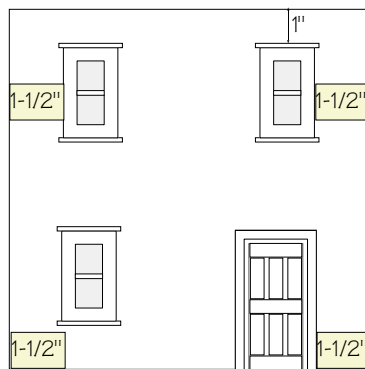

B5

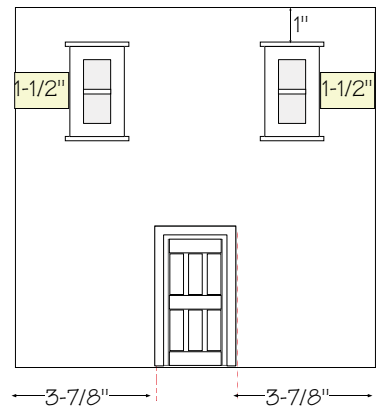

B6

Shown: Window # 1
 Can Use # 4

Can be used with any style
 one story or multi-story Building
 which has a flat roof
 or a flat roof false front

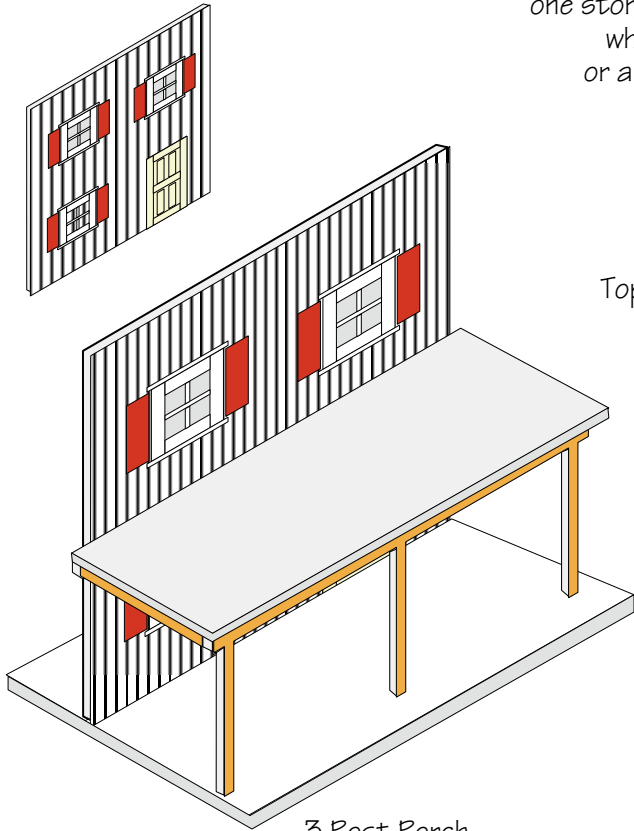

3 Post Porch
 for use with door
 off-centered.

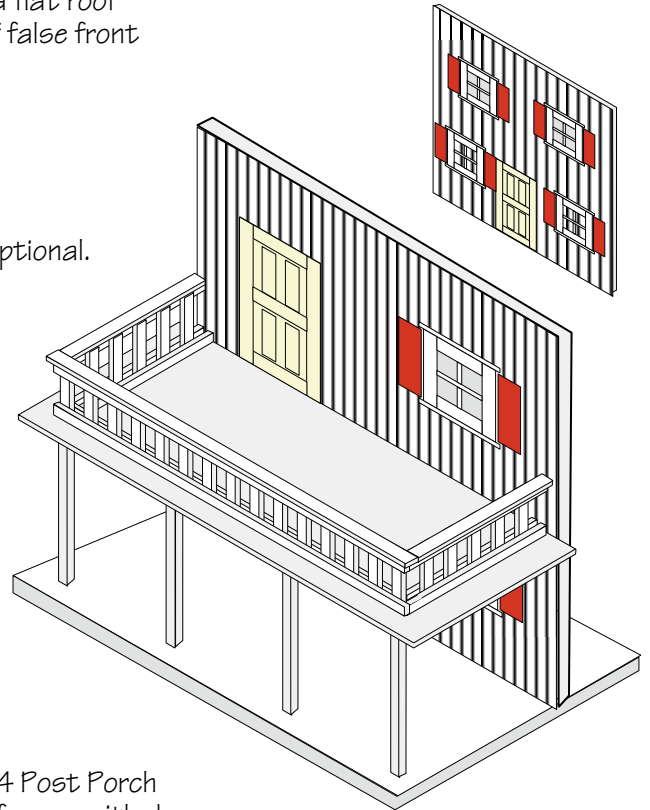

4 Post Porch
 for use with door
 centered.

Top rail is optional.

Patterns



Back
 for 3 Post or 4 Post Porch
 1/2" High x 10" Long
 Cut 1



Sides
 for 3 Post or 4 Post Porch
 1/2" High x 3-1/2" Long
 Cut 2

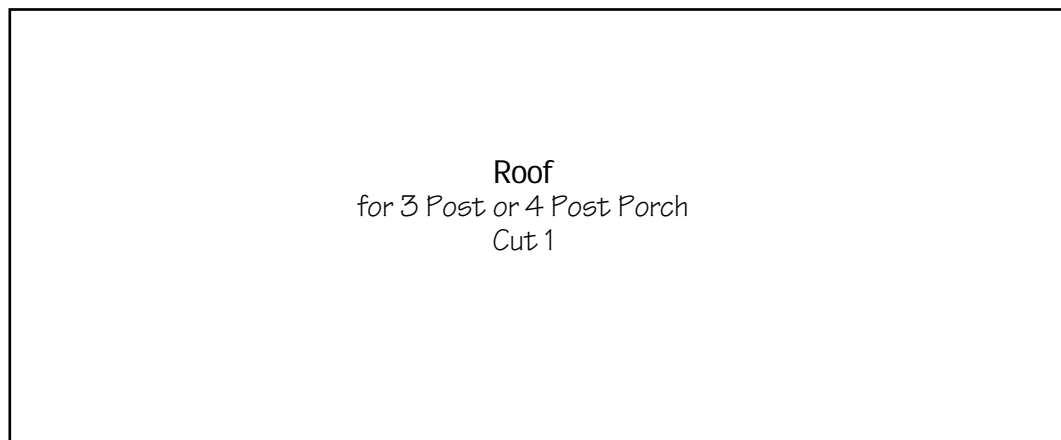

Roof
 for 3 Post or 4 Post Porch
 Cut 1

4-1/2"

11"

Patterns - continued

Choose a 3 Post or 4 Post Front according to door placement:

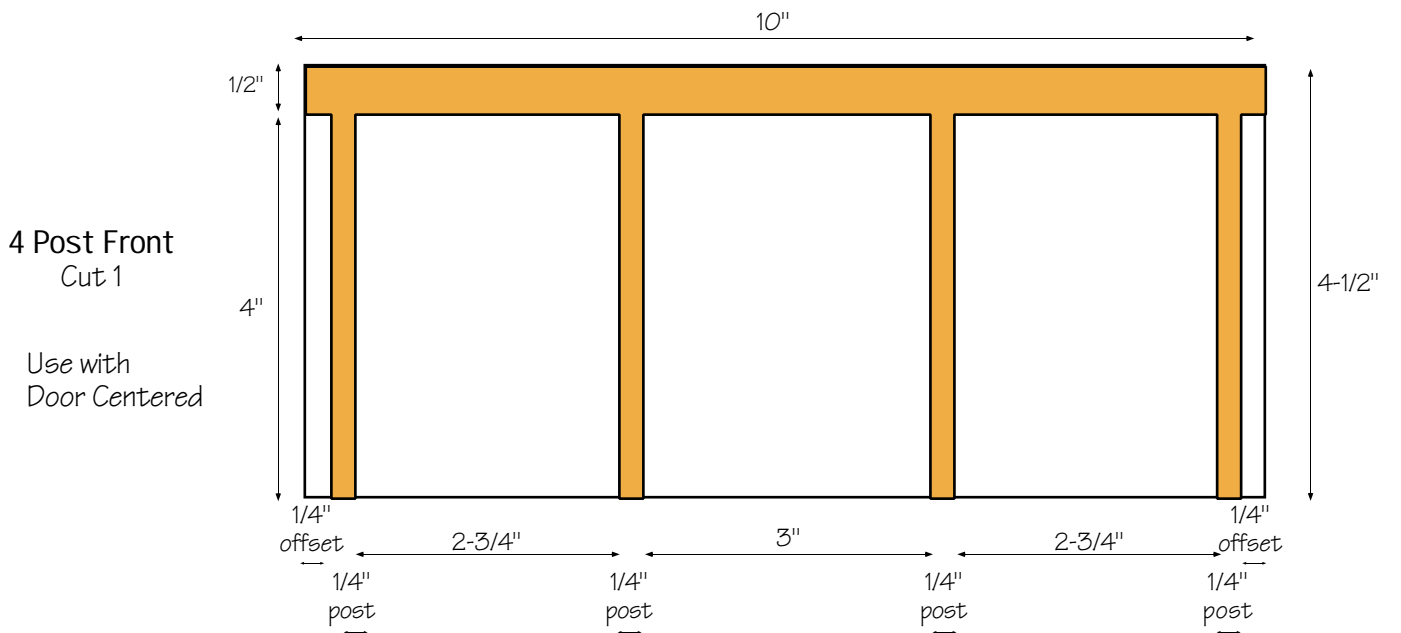
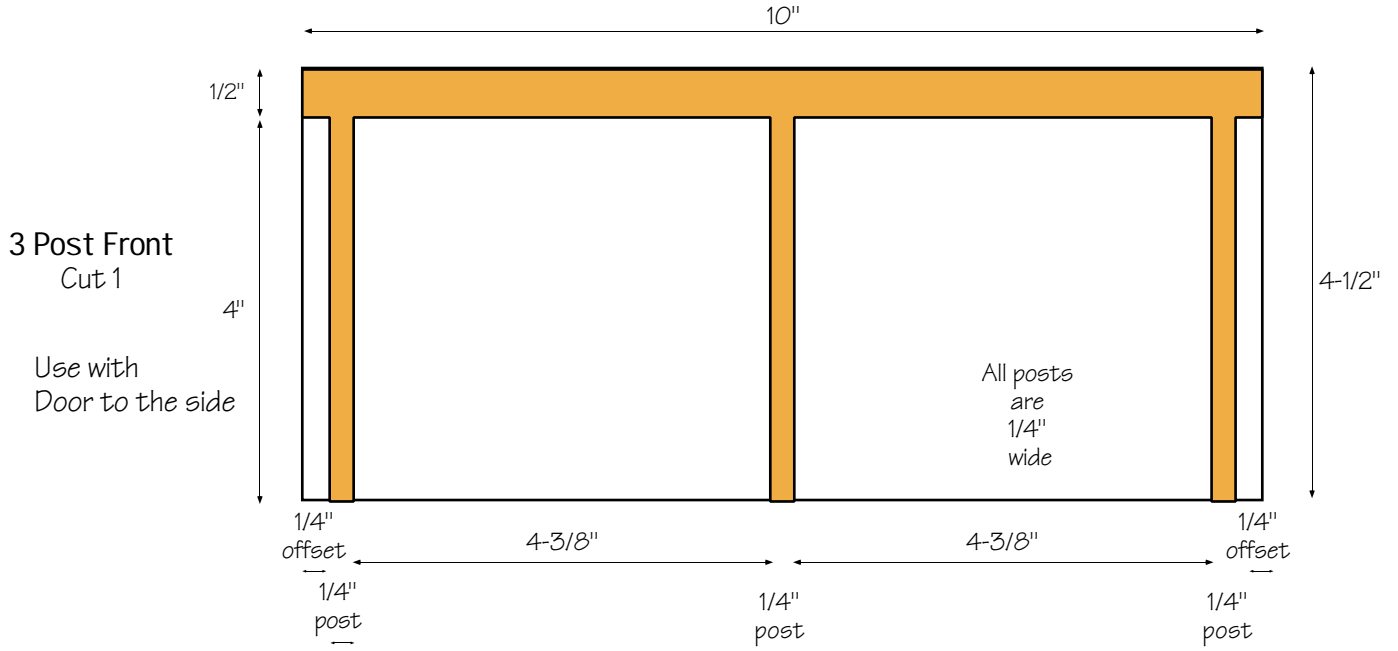

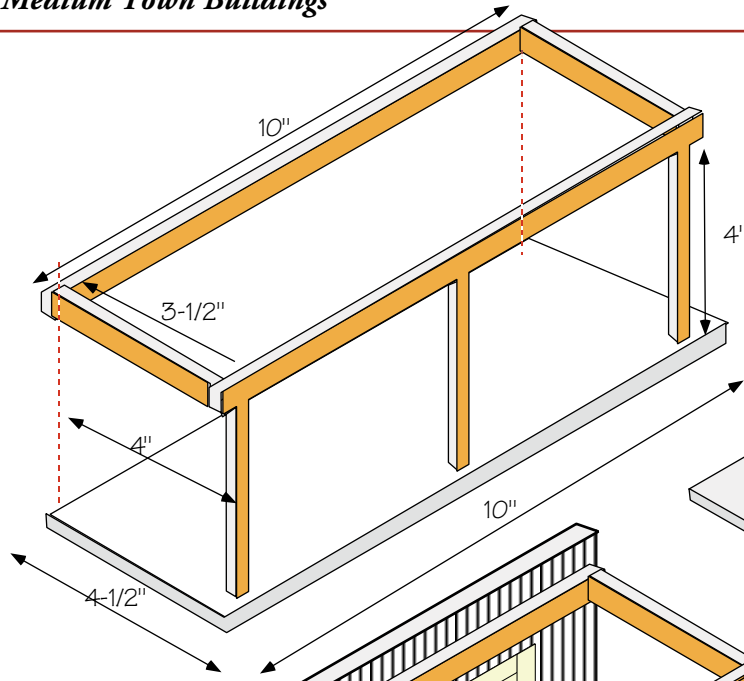

A
Note the Sides
are assembled on the inside
of the Front and Back.
Glue and nail porch as shown.

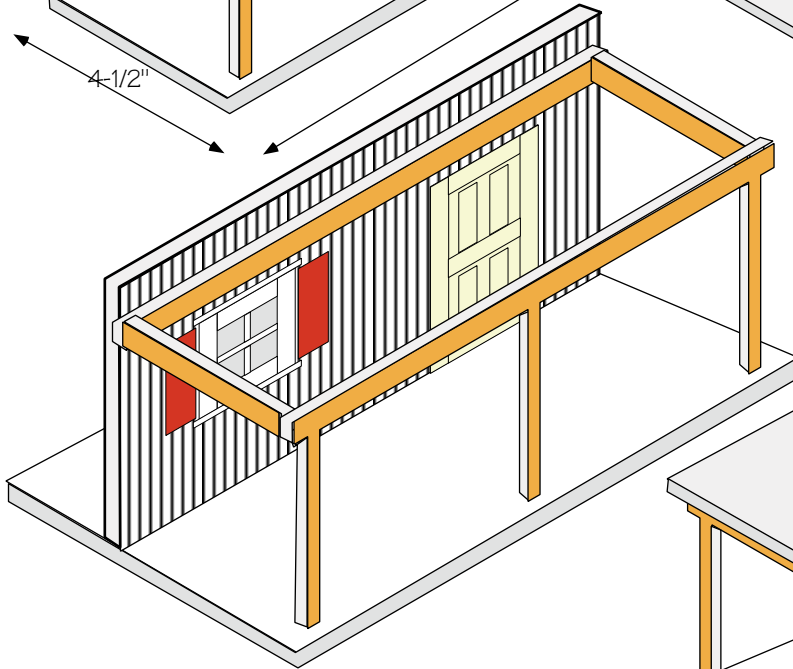
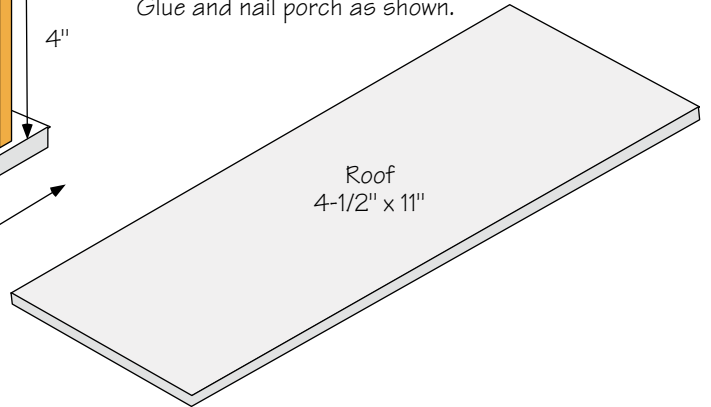

B
Glue and nail
the porch frame in
place on the building.

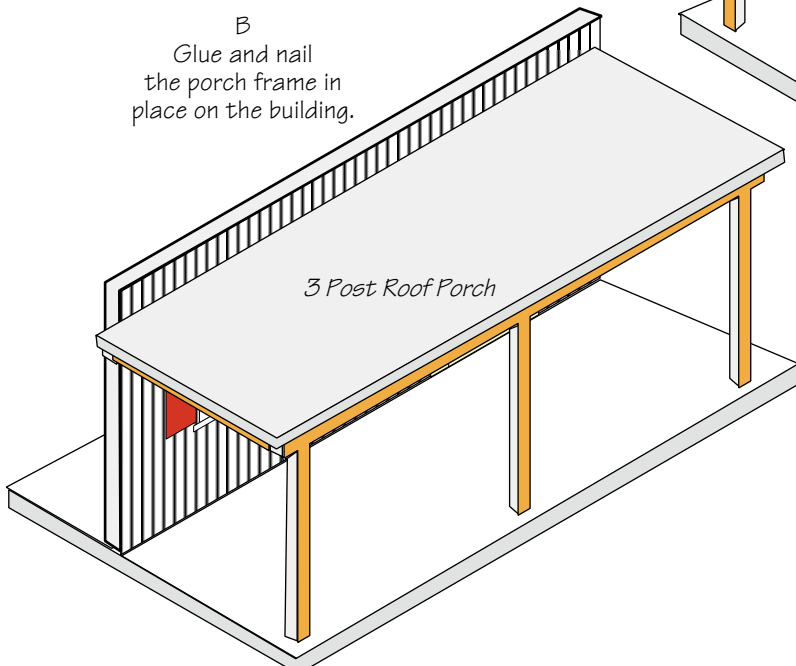
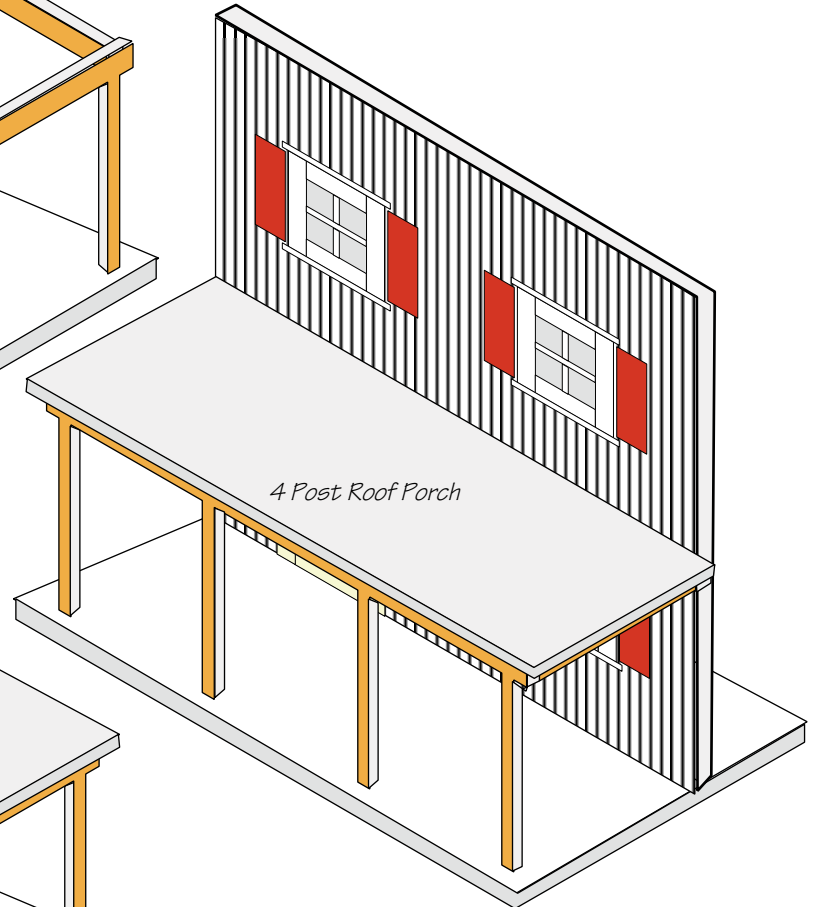

C
Carefully center, glue and nail
roof onto porch as shown.

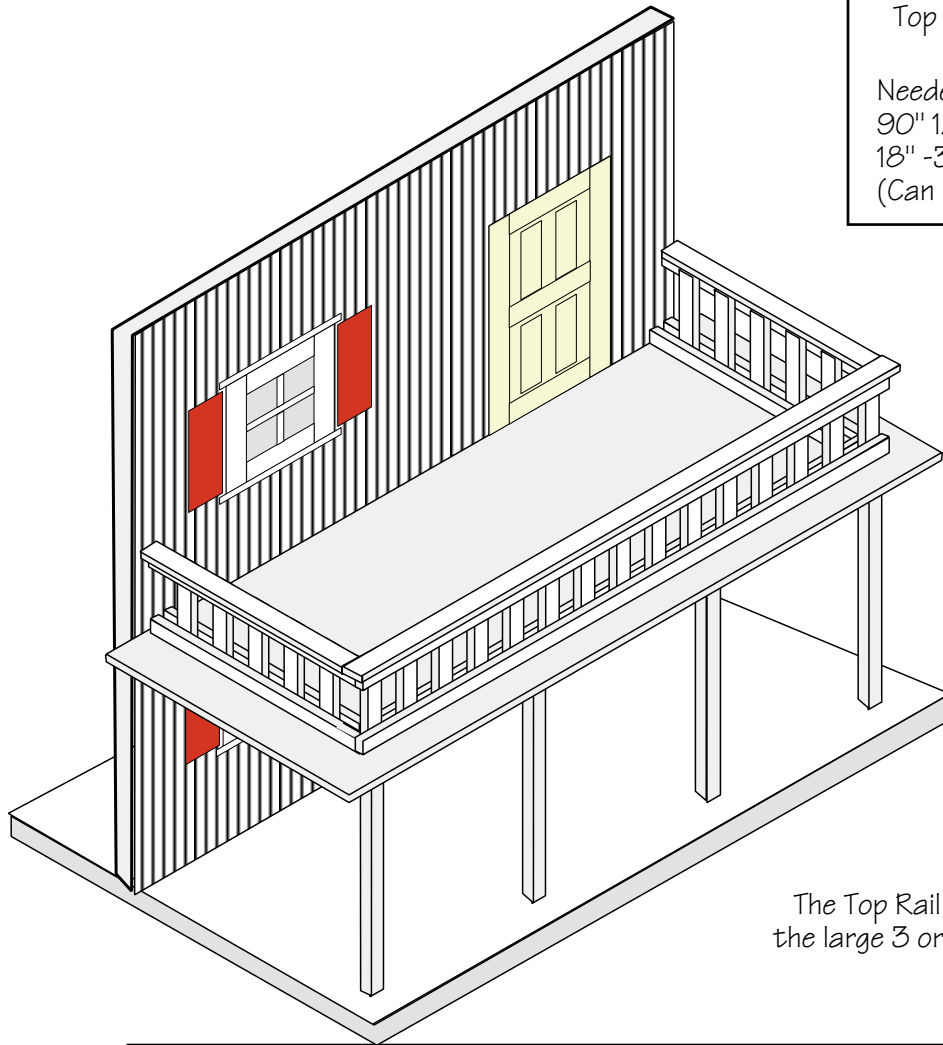

Top Rail is made from 1/8" thick Plywood or Hardwood
 Needed:
 90" 1/4" Strips
 18" 3/8" Strips
 (Can be cut from 4" x 10" piece of wood)

The Top Rail can be added to the large 3 or 4 post porch roof

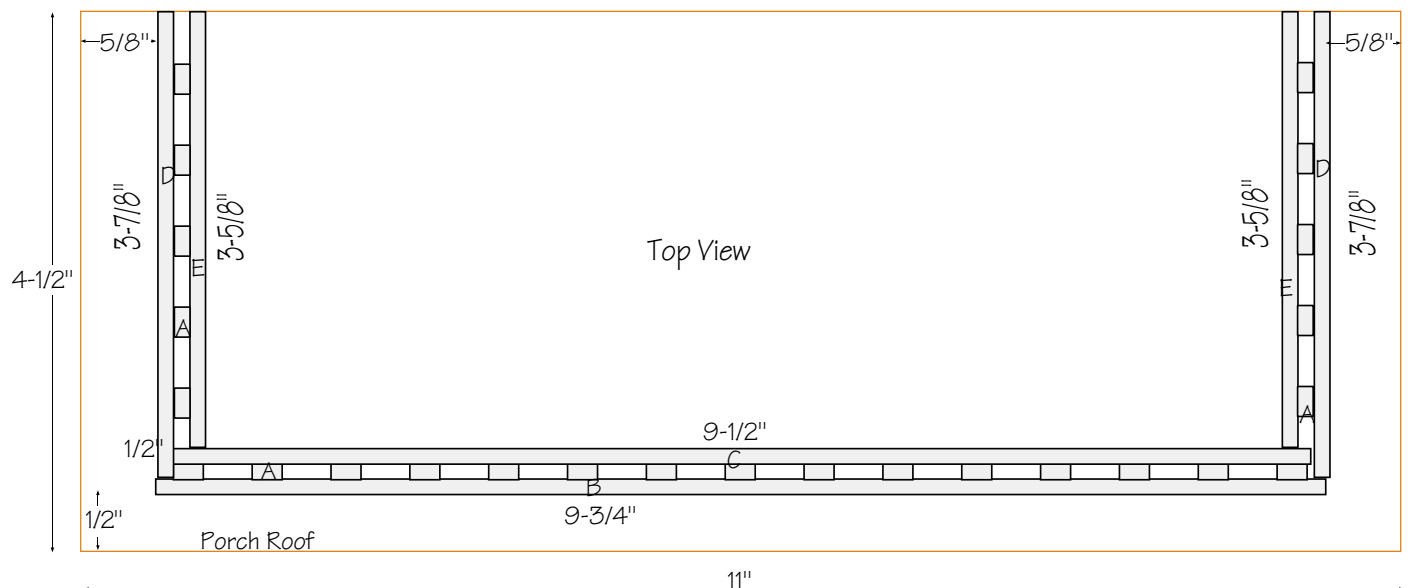
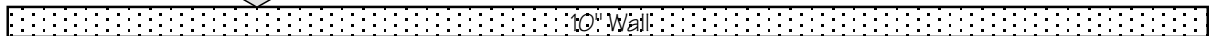

The Parts

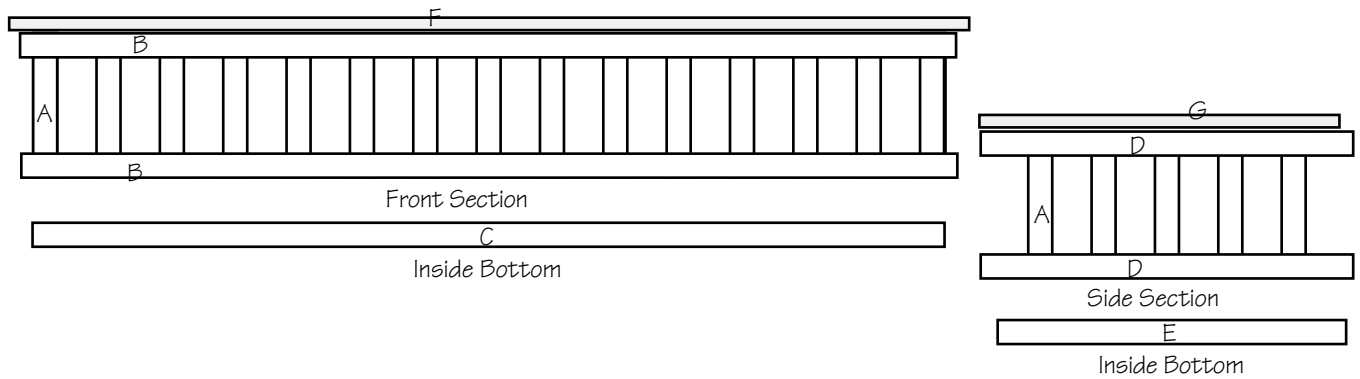

The Patterns
 All Wood is 1/8" Thick

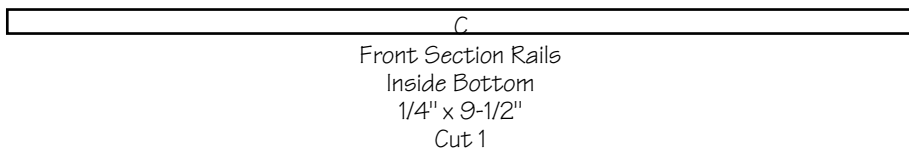
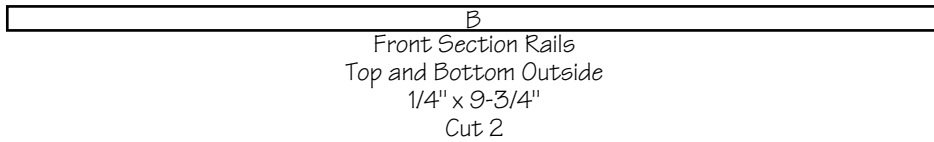

Vertical Slats
 1/4" x 1-1/2"
 Cut 25

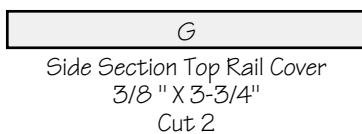
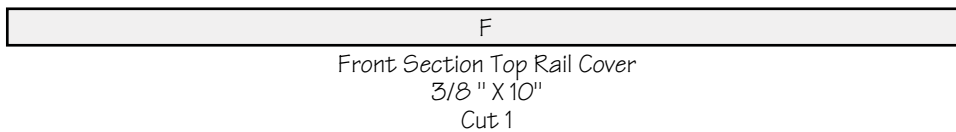
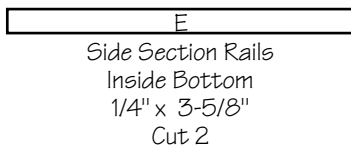
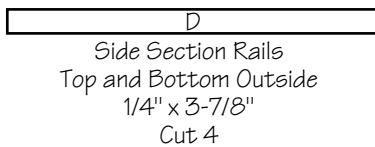

1. Cut out all Parts

Front Rail (Make 1)

2. Lay (B) Side Section Rails parallel on a flat surface 1-1/2" apart. Use the Spacing Guide on Page 9 and attach the vertical rails.

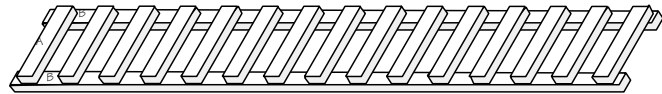

3. Center (C) Inside Bottom on the bottom and glue in place. Bottom inside rail will be 1/8" shorter on each end.

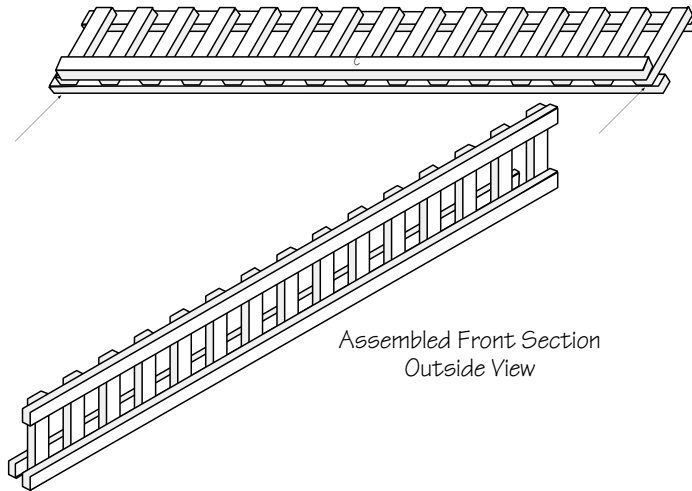

Side Rails (Make 2)

4. Lay (D) Side Section Rails parallel on a flat surface 1-1/2" apart. Use the Spacing Guide on Page 9 and attach the vertical rails.

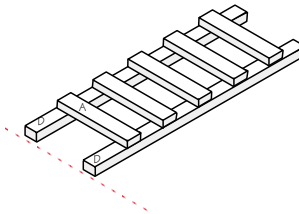

5. LH Side Rail
 Line up (E) Inside Bottom above the right end on the bottom and glue in place. Inside bottom rail will be 1/4" shorter on the opposite end.

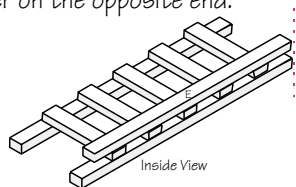

6. RH Side Rail
 Line up (E) Inside Bottom above the left end on the bottom and glue in place. Inside bottom rail will be 1/4" shorter on the opposite end.

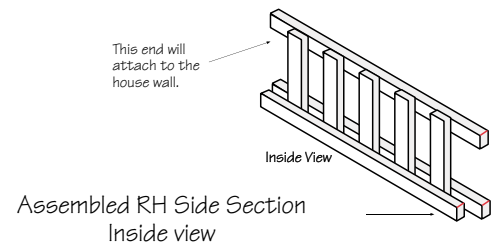
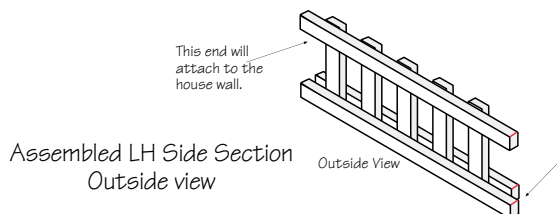
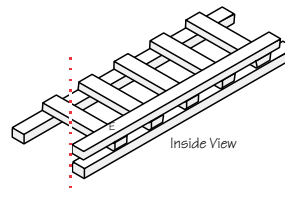

7. Lay the Top Rail Parts (F & G) on a Flat Surface, forming a 90° angle. Glue together as shown. Clamp in place until dry.

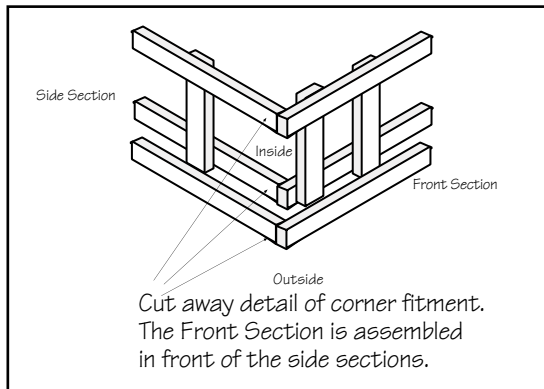
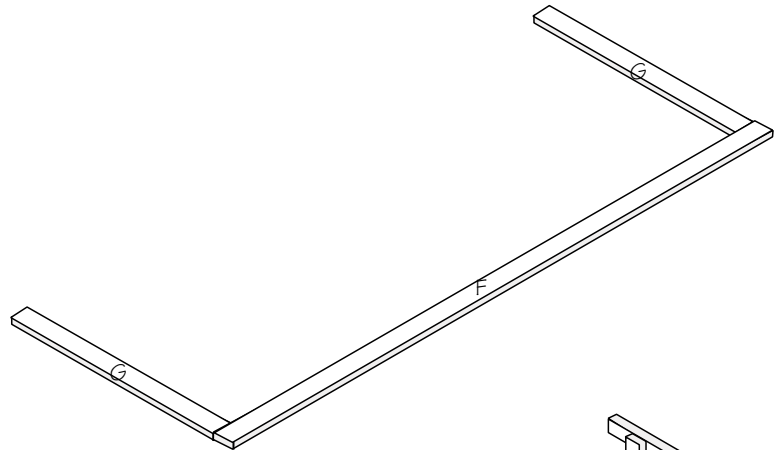

8. Glue the fence sections together.

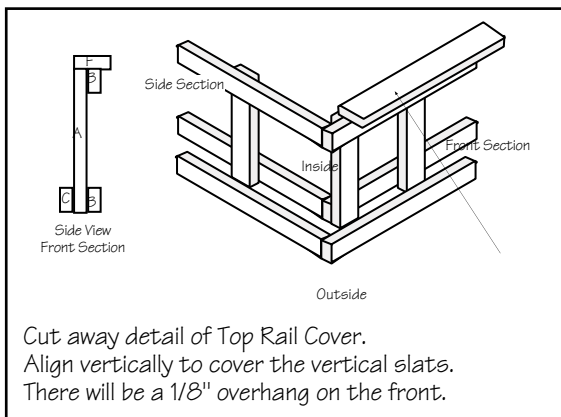
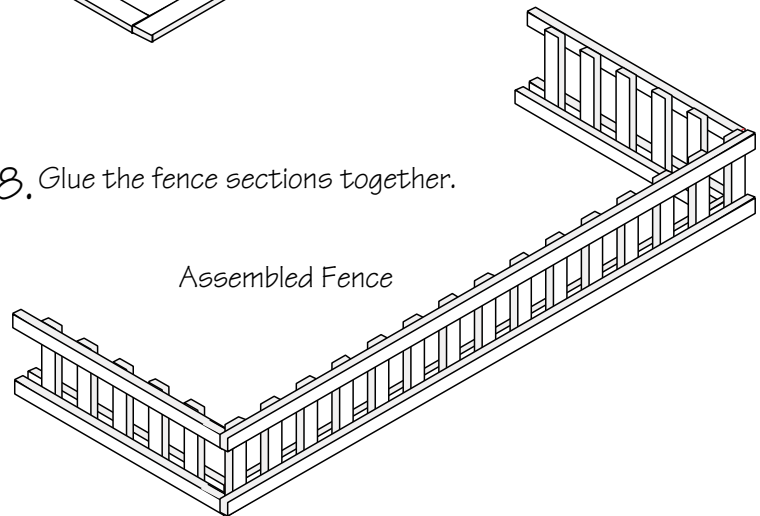

9. Glue the Top Rail to assembled Fence

Fence can then be centered and glued to the porch roof.

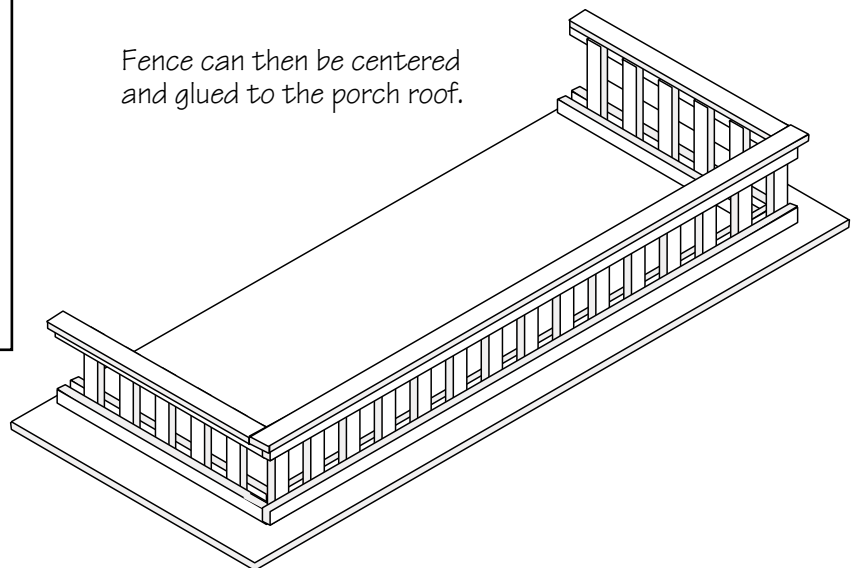

**Section Spacing Guides
are Actual Size**

(Spaces between slats
are approximately 13/32")

To Use the Guides

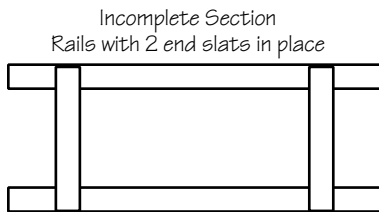
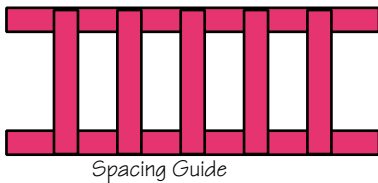

1. Measure according to instructions
and glue the two end
vertical slats to the rails.

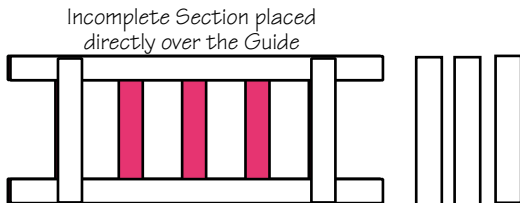

2. Lay the Incomplete Section
directly on top of the
appropriate guide

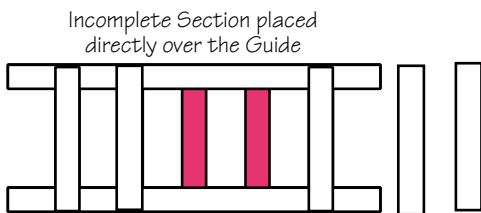

3. Place and glue all the remaining
slats directly over the
corresponding slats
on the guide.

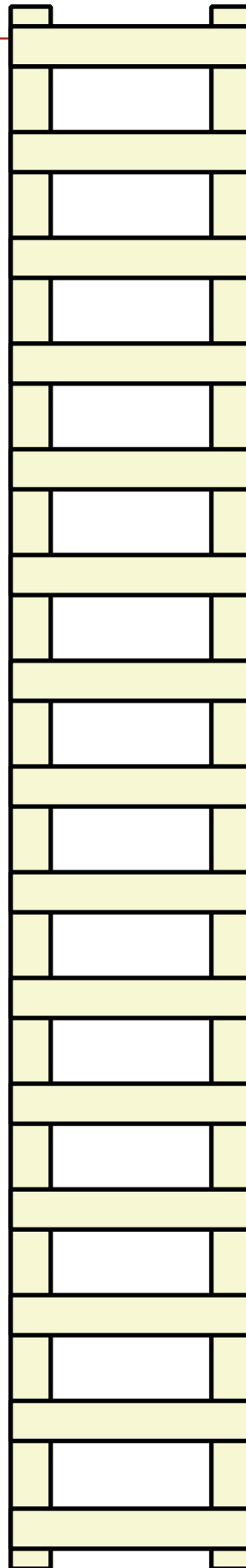

Front Section Guide for
Vertical Slat Placement

Begin 1/8" from the ends.

Side Section Guide for
Vertical Slat Placement

Begin 1/2" from the ends.

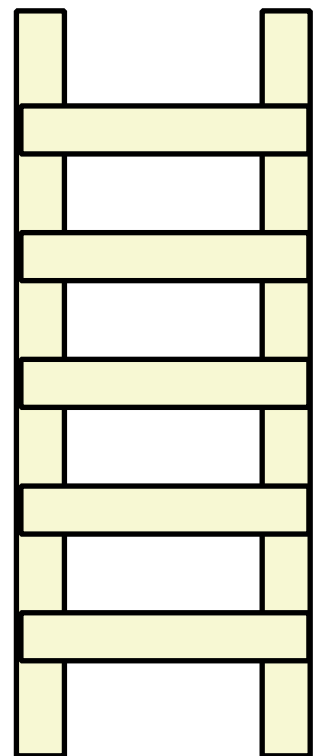

Cut from 1/4" Plywood

Front Wall (Choose between straight top or stepped top)

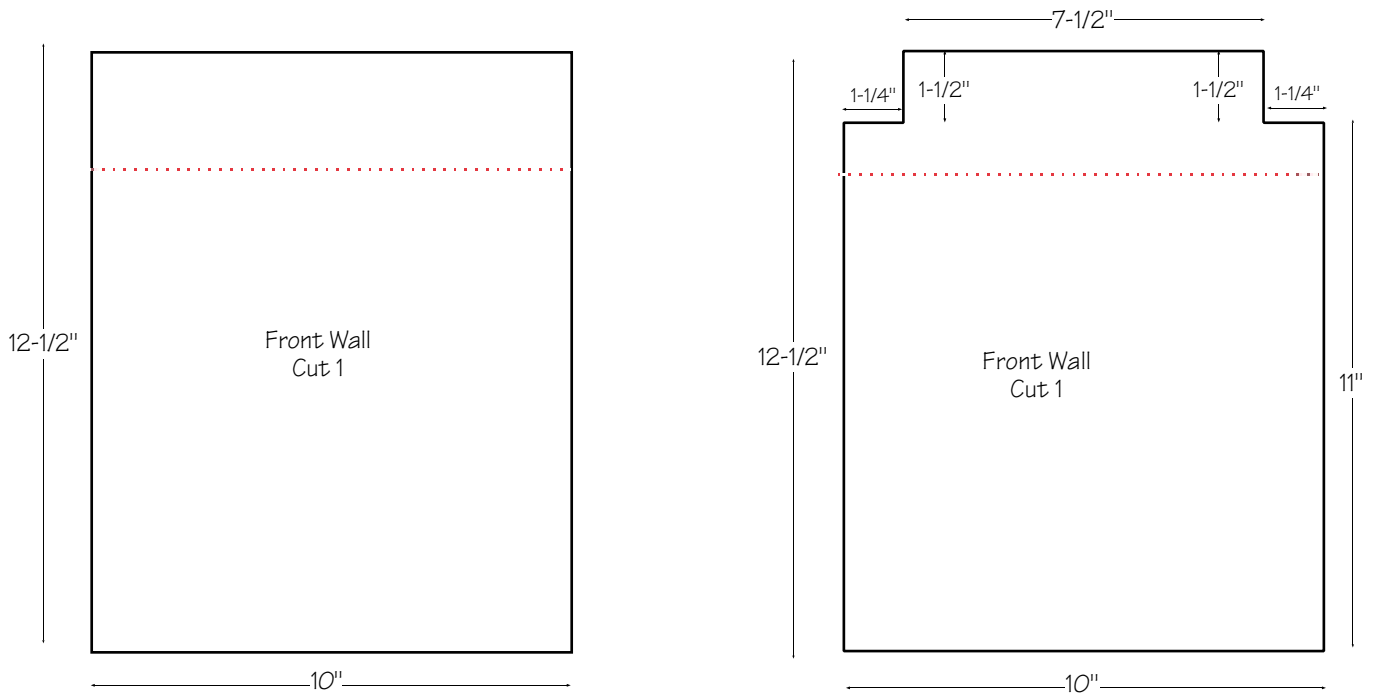

Side walls and Back Walls are interchangeable

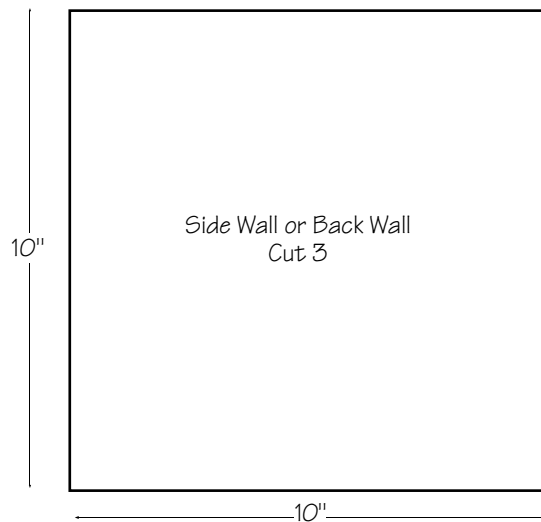

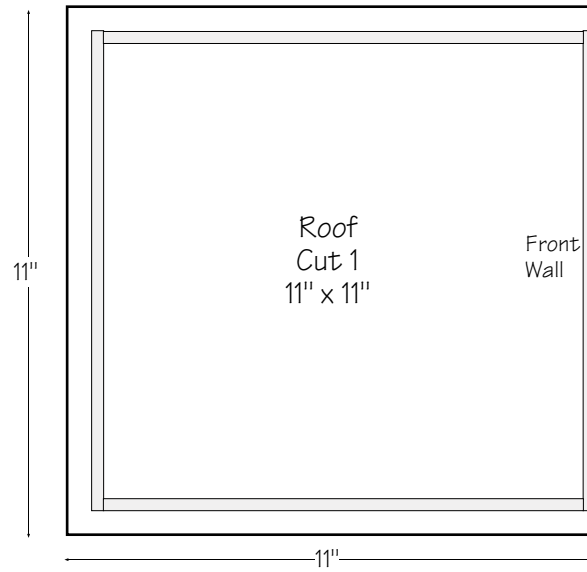

Roof has a 1/2" overhang
on sides and back only.
Wall placement is indicated for reference.

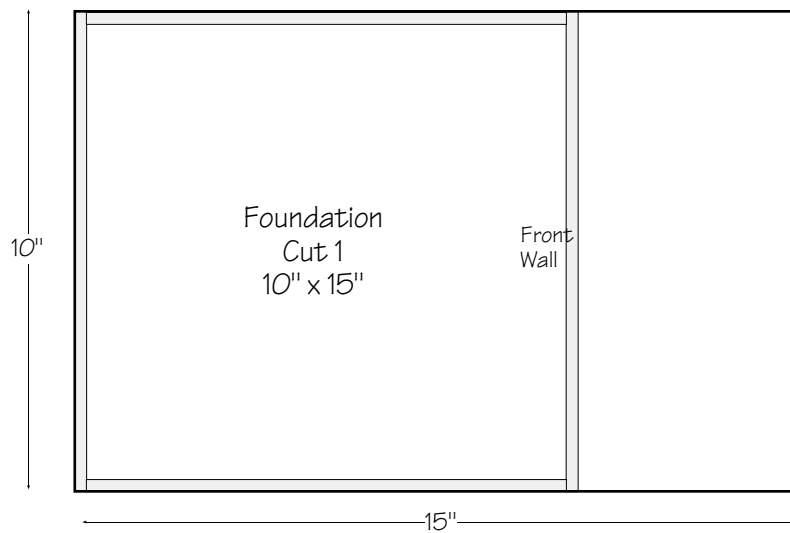

Foundation includes sidewalk or porch foundation.
Wall placement is indicated for reference.

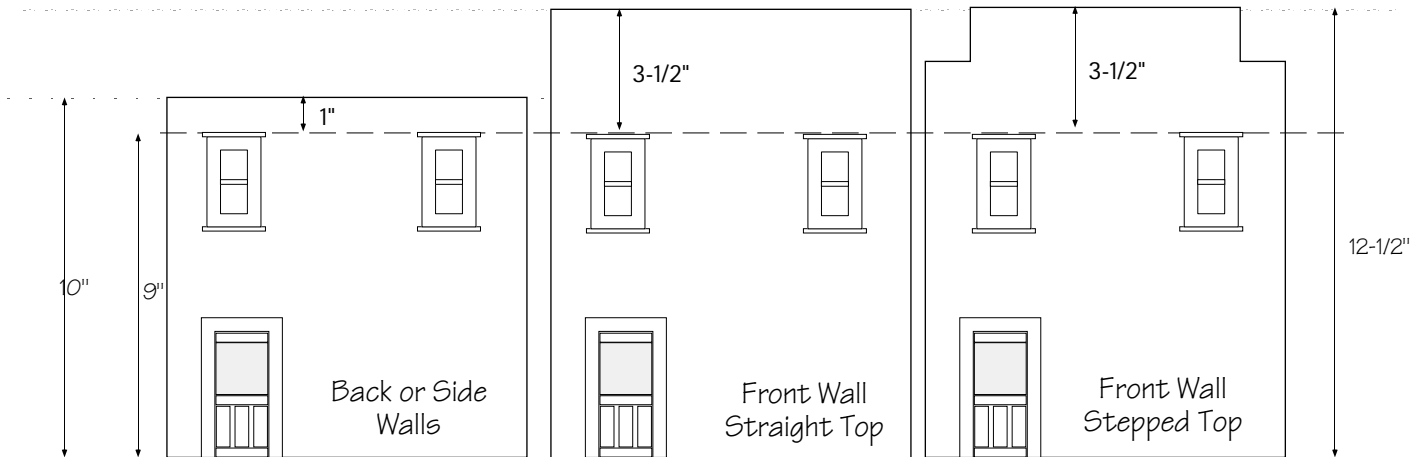
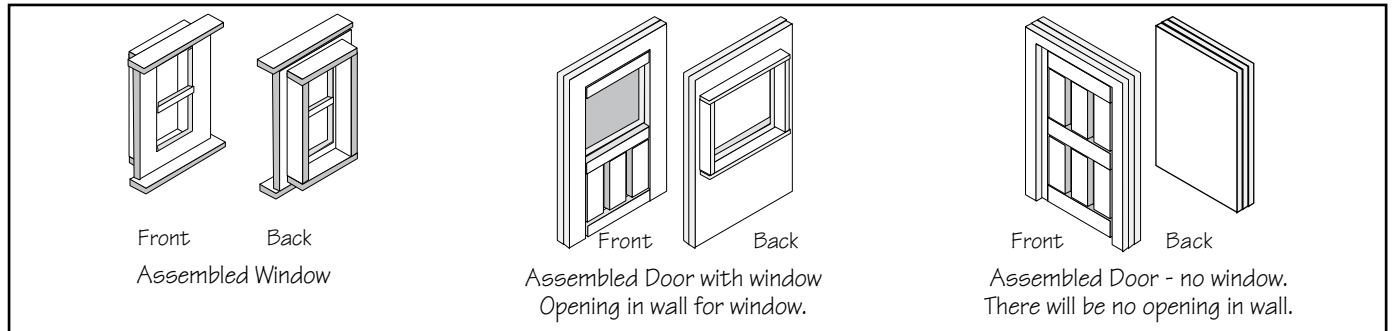

Note: The Front Walls of the Town Buildings are 2-1/2" Taller than the Sides and Back.

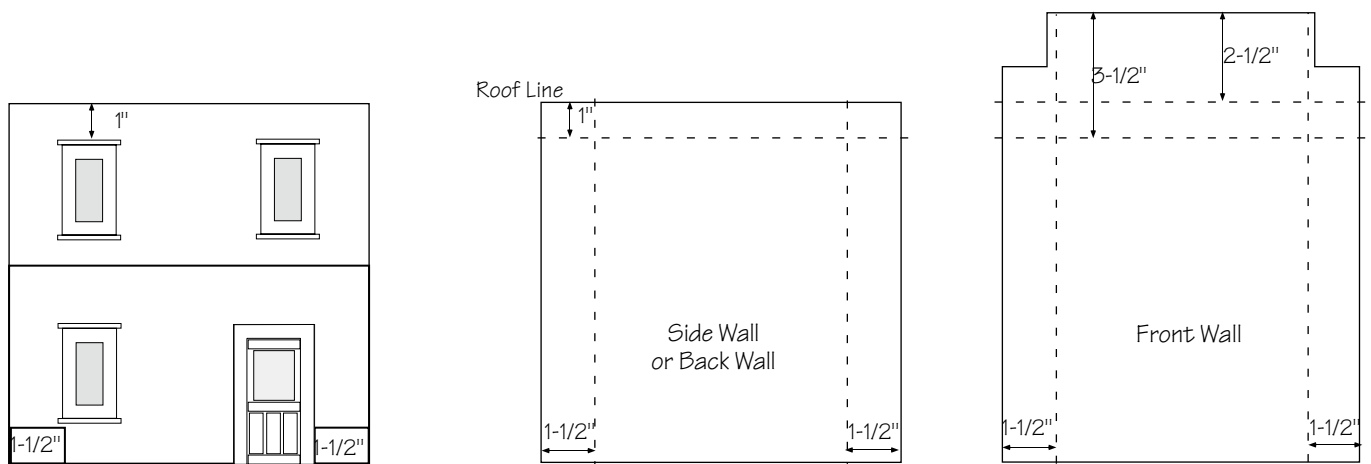

1. Decide where you want to place door and windows on the cut-out wall. The openings must be inside of the building frame behind the wall.

3. Side or Back Wall:
 • Draw horizontal line 1" from the top of the wall (roof line).

2. All Walls:
 • With pencil and ruler, lightly draw vertical guide lines on the wall sides. Minimum guide is 1" for frame clearance.

4. Front Wall:
 • Draw horizontal line 3-1/2" from the top of the wall.
 • Draw second horizontal line 2-1/2" from the top of the wall (this is the roofline for the front wall).

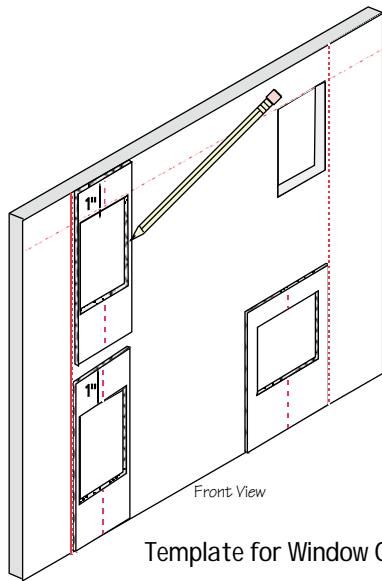

Template for Window Opening in Wall

5. Using your side guide lines, place the template as follows.

Ground floor:

Bottom of template will be on bottom of wall

2nd floor - Side wall or Back Wall -

Top of template will be on top of wall

Front Wall -

Top of template will be on the 2-1/2" Guide Line (roof line)

Using template and pencil, mark the window opening on the building. Cut out opening on building. The opening is now ready for the finished window.

Door should be painted or stained before you actually insert and secure it into the building.

6. Before gluing windows, check to see that they will easily fit the wall openings. Trim openings if necessary.

Place some wood glue on the flat backs of the finished window and door with window. (around the frame) This will adhere to the front of the wall.

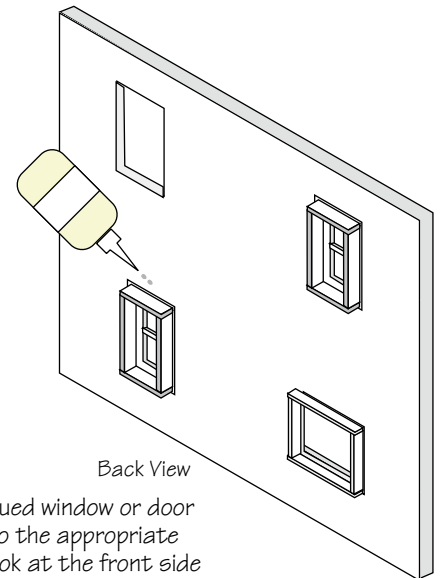
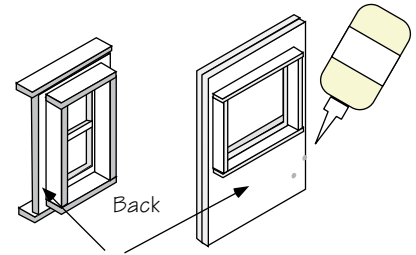

7. Insert the glued window or door with window into the appropriate wall opening. Look at the front side and using a level, make sure the window is straight. Run a bead of wood glue around the window brace. Allow the glue to dry.

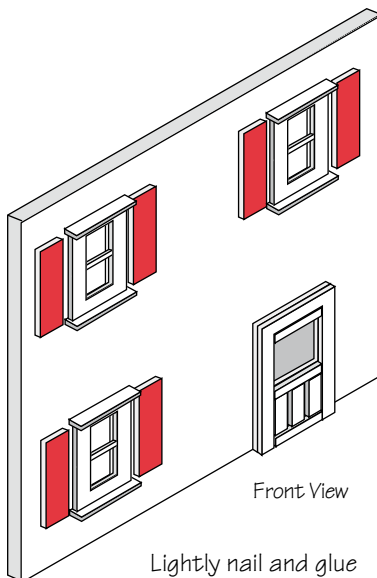

Lightly nail and glue shutters in place.

Doors and windows can be installed before building is assembled or after the walls are assembled before adding the roof.

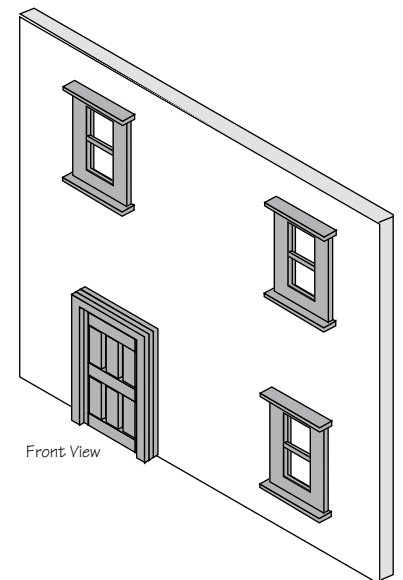

Door with no window does not have a wall opening. Lightly nail and glue door in place.

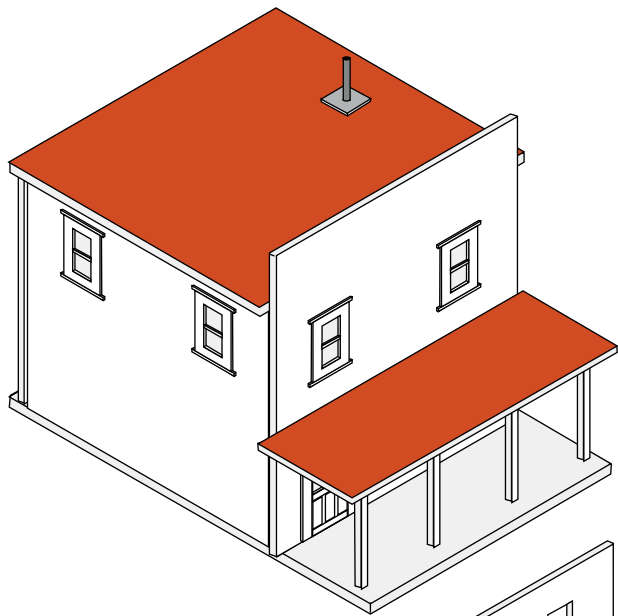

1. Cut out all pieces needed to assemble your building

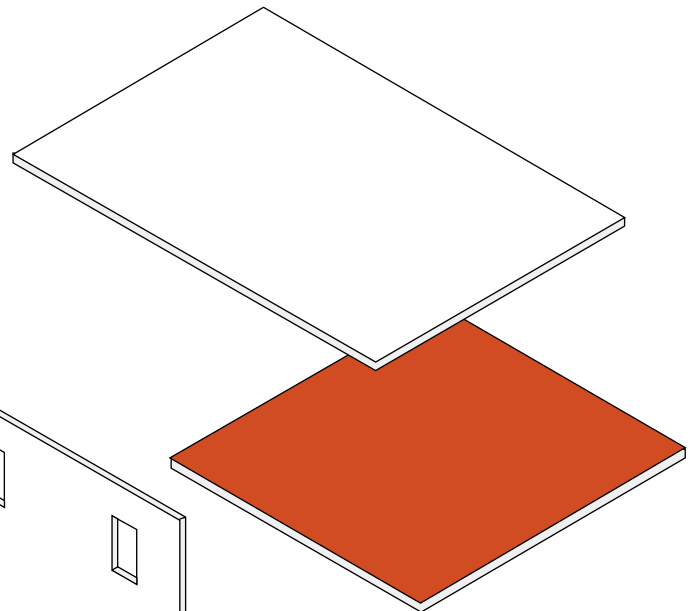

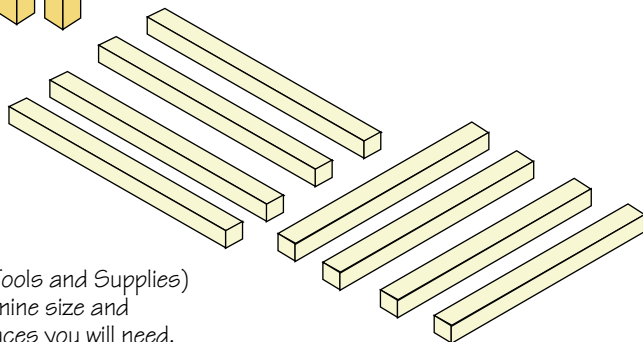
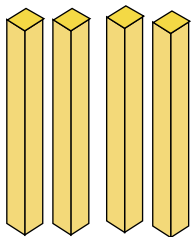
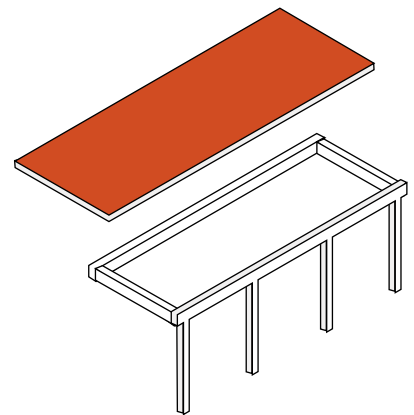

2. The Walls - See Assembly - Walls cut out windows and doors



See Framing (Tools and Supplies) to determine size and number of braces you will need.

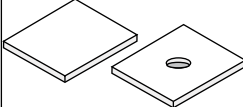
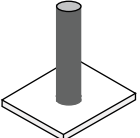

Detail of Rooftop Pipe (Enlarged)

 1/8" x 1" Dowel (Can use 1/4")	 3/4" x 3/4" Scrap wood 1/8" to 1/4" thick
 Drill hole in center of pipe base (1/8" for 1/8" dowel)	 Glue dowel in hole.
Paint black and attach to roof	

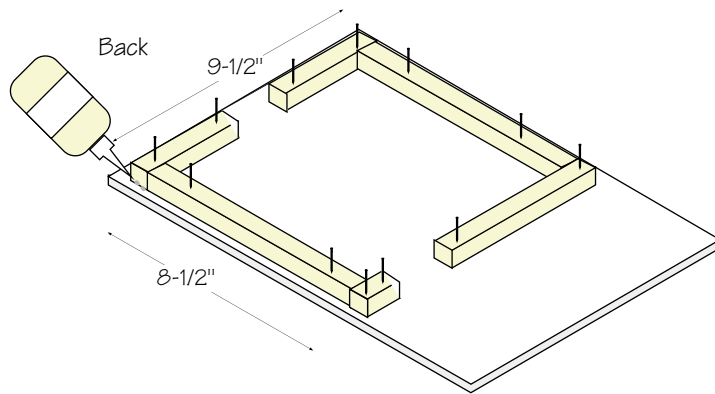

Note the longer braces are for the front and back of the building. Side wall braces are assembled inside the front and back wall braces.

2.

Bottom Brace (1" Furring Strips)

- Measure 1/4" inside the foundation. (For depth of the walls)
- Lay the Brace pieces out on the foundation.

If you are using opening doors, cut out appropriate spaces wherever you wish to place the doors. For non-opening doors, do not cut openings: simply build a "box" as per instructions in Framing (Tools and Supplies)

- Glue and nail or staple the bottom house brace together, maintaining right angles at corners.

3. **Top Brace (1" Furring Strips)**

- Lay the pieces out on a flat surface, using continuous pieces. (No openings for doors.) The overall dimensions will be the same as the bottom brace.

- Glue and Nail or staple the bottom brace together, again maintaining corner angles.

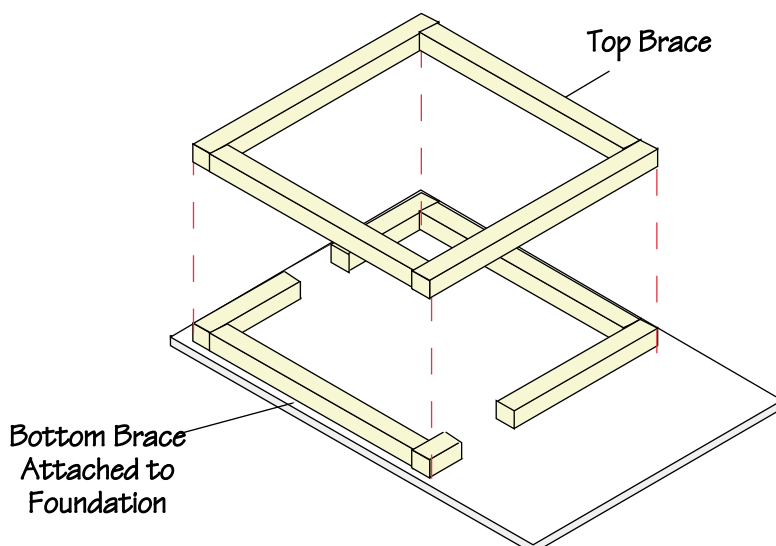
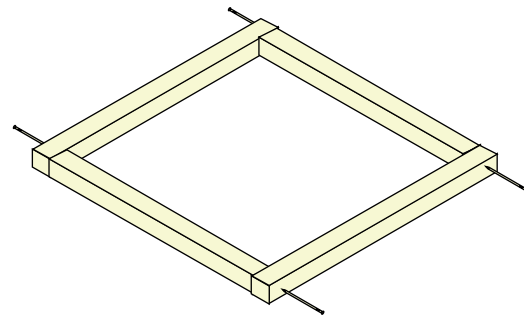

4.

Check Alignment of Horizontal Braces

- Position the Top Brace over the Bottom Brace to ensure that the two pieces are in alignment.
- The two braces should line up vertically and be the same dimensions on all sides. If they don't line up, double check your work and make adjustments. (Favorite thing to do)
- Then lay the Top Brace aside.

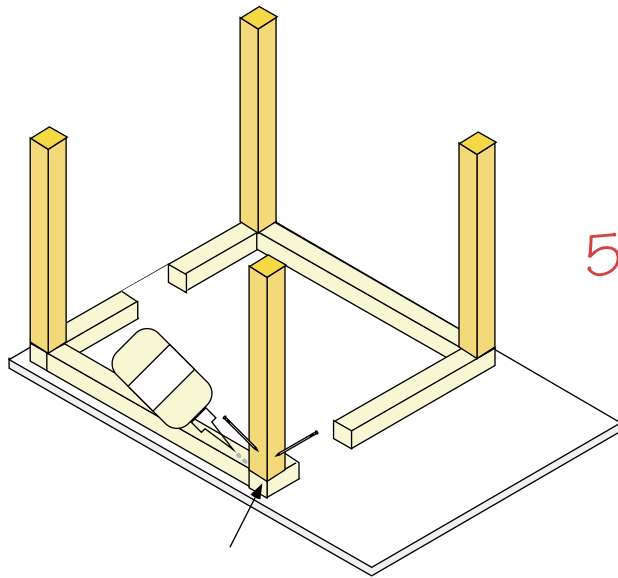

5. Vertical Studs

Each wall needs a vertical stud on each end. Lightly glue and nail or staple a vertical stud at each corner for the walls to be attached to.

Note: Nailing the studs in place will be much easier if you begin with drilling a small pilot hole for the nail.

6. Lightly glue the tops of the vertical studs. Place the assembled top brace on top of the vertical studs, matching up with the bottom brace. Nail or staple the top brace to all vertical studs.

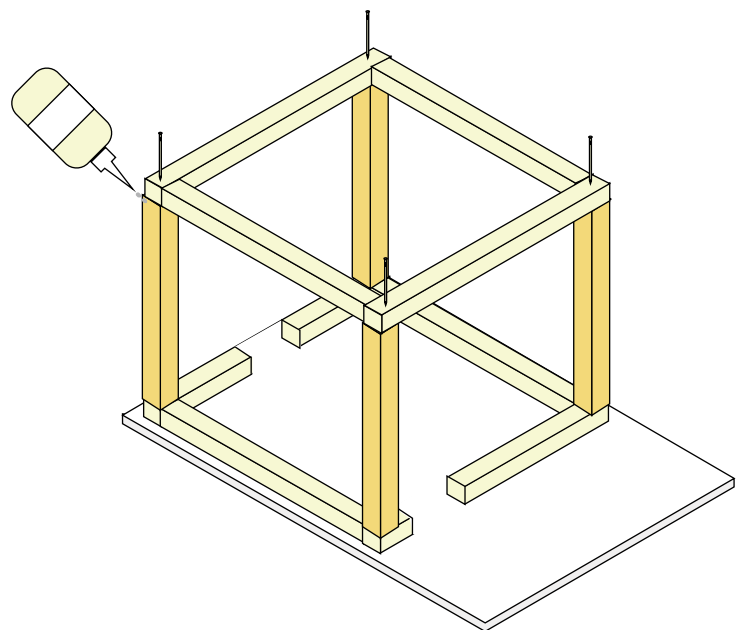
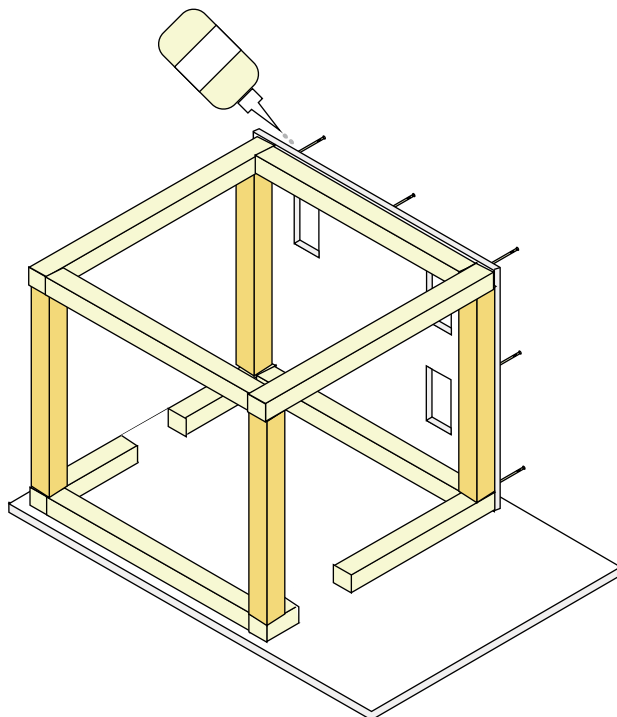

7. Start at one end of building and nail or staple walls in place to the frame. Work walls together in a clockwise or counterclockwise direction. Direction doesn't matter. Just fit the adjacent walls and keep going in the same direction.

8. Continue adding walls until all walls are in place.
• Always nail or staple into the frame.
Check that each wall is sturdily attached and that there are no "floppy" walls.

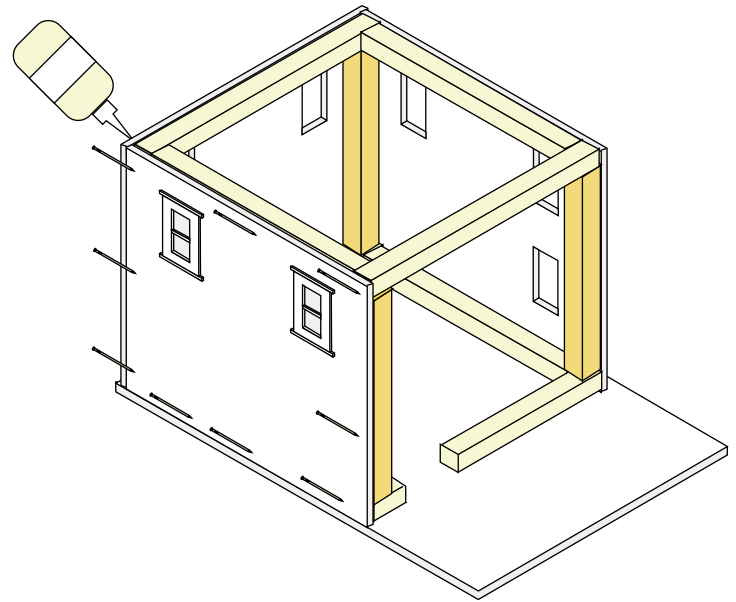
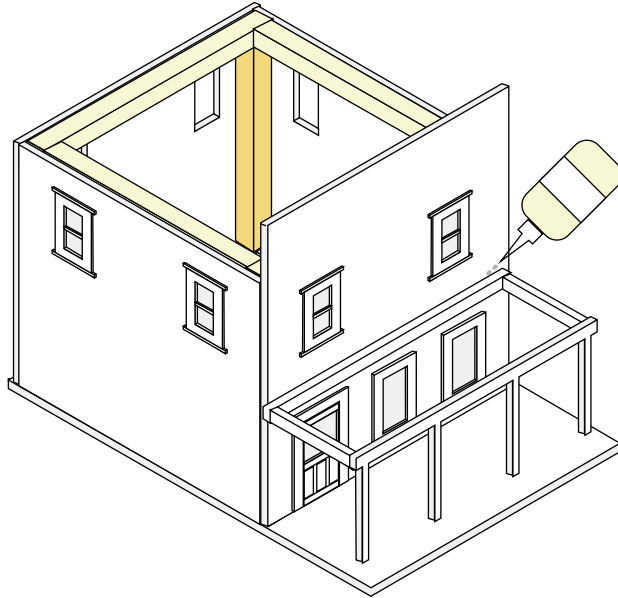

9. Position and attach the porch frame to the house wall.
(Staples and glue)
Be sure to secure the posts to the foundation. When dry, carefully center and attach the porch roof.

10. If you haven't already installed the doors and windows, do so before putting on the roof.

11. Note: If you are adding lights to your house use screws to attach the roof.
This will enable you to have future access to the wiring.

OR

Run a bead of glue around the exposed wood that the roof will sit on.
Carefully center the main roof in place.
Glue and nail or staple to the building, nailing into the frame.

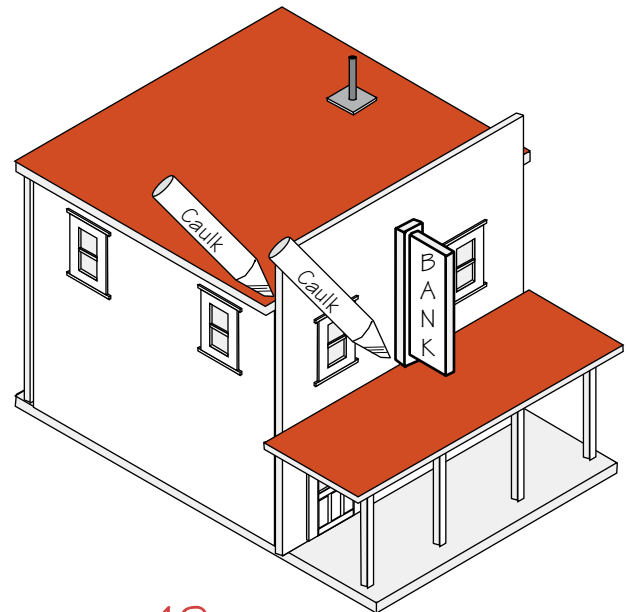

12. Caulk seems as needed for example porch roof and the back side of the front wall where it joins the roof.

Building is ready to paint or stain and seal.
Optional: Make a sign with the name of your choice of business.