

Scaled and easy to read patterns and instructions  
for a house made from wood.  
Compatible with Garden Scale Railroads  
and Garden Town Houses or Buildings

- Build House from 1/4" plywood
- Build doors and windows from 1/8" Balsa wood  
or Hardwood and plastic glazing for panes.  
Garden Towns Doors and Windows patterns sold  
separately.

Basic House Patterns  
include  
Walls, roof, and  
foundation

Accessories Patterns:  
Room Addition  
Porch  
Rooftop Chimney  
Ground Chimney  
Dormer

Overall Dimensions  
Foundation: 10" x 15-1/2"  
Walls: 10" high with app. 18-3/4" roof peak





## Introduction

Thank you for purchasing our Garden Towns House pattern. It was designed to accompany the Garden Town Houses and the Garden Town Buildings series. All were instigated by a happy retired "dad" who loves trains of any size and most recently the Garden Scale Trains. However, the scaled buildings can be used to add interest to your flower gardens, fish pond or whatever ideas you may have. They can be used as a backdrop toy for a child. They are as unique as you wish to make them and inspire a nostalgia for a few years gone by.

Enjoy your project!

## Table of Contents

	Page
<b>Before You Begin</b>	
<b>Tools and Supplies</b>	
General	3
Working With Small Items	4
Layouts -	
The House	5
Accessories Detail and Frame	6
Doors and Windows	7
<b>Hints and Tips</b>	
Mitering	8
Construction	10
<b>Choosing Your House</b>	11
Patterns - Walls and Roofs	14
Walls - Door and Window Placements	17
Walls - Assembly	21
<b>Accessories (Patterns and Assembly)</b>	
Chimney	23
Dormer	27
Porch	29
<b>Assembly - The House</b>	31

- Buildings are constructed from 1/4" thick plywood.
- Framing for the walls is made from 1" Furring strips (nominally 3/4" thick)
- Garden Town Doors and Windows are made from 1/8" thick Balsa wood or  
Hardwood and plastic glazing for the window panes

For a few hints to experiment with on the wall finishes, see "Simulated Patterns" in our free **Food for Thought** brochure.

**Tools Needed for Building**

- Saw (for cutting small wood pieces, a jig saw or coping saw)
- Hammer or Stapler or Air Gun
- Optional: Drill for pilot holes
- Clamps
- T-Square
- Level
- Ruler and Pencil (We prefer see-thru rulers with grids for the small pieces)

**Plus If you are making Doors & Windows from Balsa wood**

- X-Acto knife and metal ruler for guide
  - Optional:**
  - Ruler - the plastic see-thru kind with 1/8" grid is a plus
  - Balsa stripper - This little gizmo is used for making various widths of uniform strips from balsa wood. You can set it to cut small widths, (1/8", 1/4", 1/2" etc.)It saves a lot of time if you prefer to cut your own strips.
- Of course you can buy the strips "ready made" at a higher price.
- Clamps (small) - For example, the X-Acto clamps for small pieces are very handy.

**Supplies Needed - General**

- 5/8" Staples or Brads
- 2" Finishing Nails
- 3/8" to 1/2" Small Flat Head Wood Screws
- Wood Glue suitable for outdoors
- Paint or Stain-  
We suggest the water based Acrylic Paints found in a multitude of colors in arts and crafts stores.
- Sealer -  
Water Base Varnish found with the acrylic paints or a sealer such as polyurethane.
- Optional: Caulking for sealing porches, roofs, etc.

Guide for 1" x 1" x 8' Furring Strips		
1	8'	96"
2	16'	192"
3	24'	288"
4	32'	384"
5	40'	480"

**Optional - Items to consider from the hobby store:**

Lights- Add Lights according to manufacturers instructions.

You can buy scaled wood shingles for your roof, as well as assorted other detailed items. Make your own signs with help from a stencil or the stick-on letters and numbers available.

Conversion Inches =	Feet
12"	1'
24"	2'
36"	3'
48"	4'
60"	5'
72"	6'
84"	7'
96"	8'
108"	9'
120"	10'
132"	11'
144"	12'
156"	13'
168"	14'
180"	15'
192"	16'
204"	17'
216"	18'
228"	19'
240"	20'
252"	21'
264"	22'
276"	23'
288"	24'
300"	25'

Specific Building Supplies		For Details See Page
<b>1/4" Plywood</b> (No. of Sheets)	48" x 48" (1) 4' x 4'	5
<b>1" x 1" Furring Strips (nominally 3/4" x 3/4")</b>		6
Total	178"	
<u>Purchase Doors and windows, as required or build your own from:</u>		
<b>1/8" Balsa or Hardwood (4" x 36" Boards)</b> Doors & Windows - See Details		7
<b>Clear Plastic Glazing for Windows</b> 8" x 10"		7
<b>Wood Dowel for chimney top (optional)</b> 1/2" dia x 1/2"		
Optional Small Parts Frame - Page 4 1/4" Plywood - 12-3/4" x 12-3/4" 1" x 1" Furring Strips - Add 52"		

### Assembly Frame for Small Items

Cut from plywood -1/4" thick or any scrap

#### Patterns

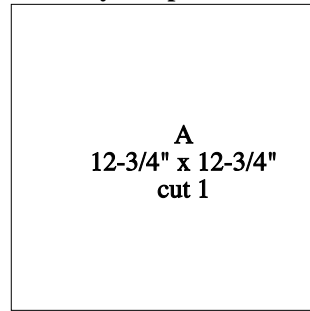

Cut from 1" x 1" Framing (nominally 3/4" x 3/4")

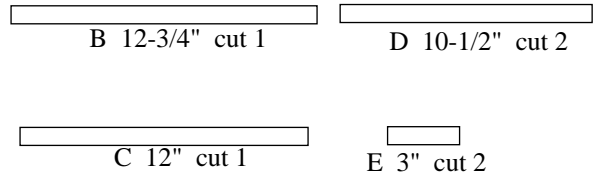

#### Assembly

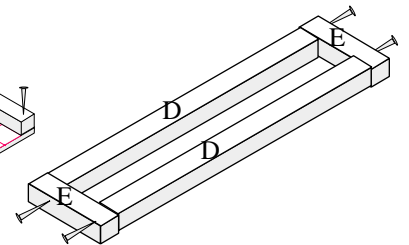
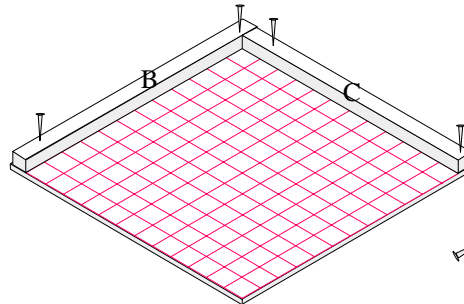
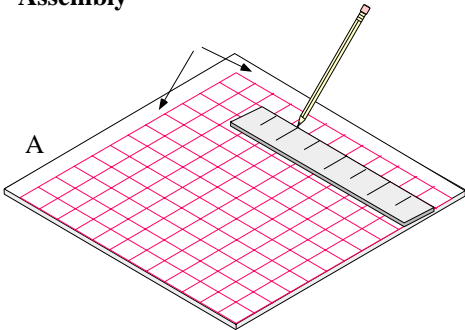

1. Using pencil or pen and ruler, draw lines 3/4" inside of 2 adjacent sides of the base. The frame will be placed in this area. From those 2 lines, draw lines at 1" intervals, forming a 1" grid.

2. Nail and glue frame parts B and C in place, as shown, maintaining a square corner.

3. Using glue and nails, assemble the frame "push bar", as shown. Again, make sure that the corners are square.

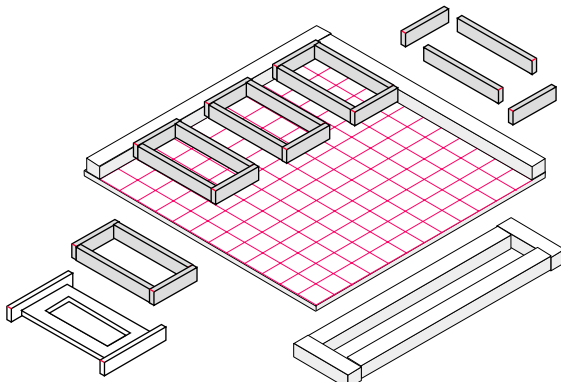

4. Glue parts and assemble inside the frame. The grid will help you keep the pieces straight. You can assemble several "like" pieces at one time.

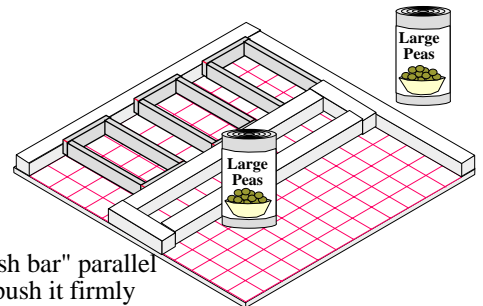

5. Keep the "push bar" parallel to side C and push it firmly against the assembled parts. Use anything with weight to hold the push bar in place until parts are dry. Canned goods you didn't want for dinner work well.

### Trimming 1/8" Balsa wood or hardwood

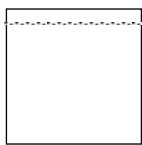

1. Using ruler and pencil make a line 1/8" from the inside edge to be mitered

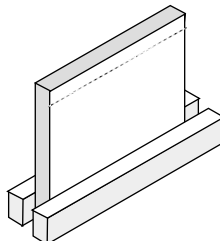

2 Stabilize the piece to be mitered with a clamp or other means

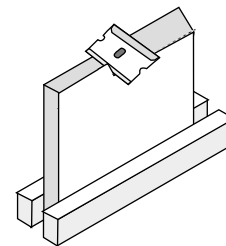

3. With blade, carefully trim from the top outside to the marked line. Alternately, the piece can planed or sanded.

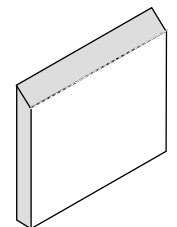

Trimmed on the inside

Note:

The space allowed for foundation and additions represents the Basic Foundation and room for Addition placements, according to the floor plans provided.

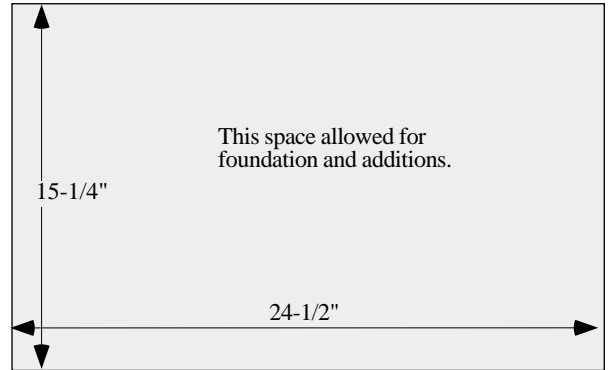
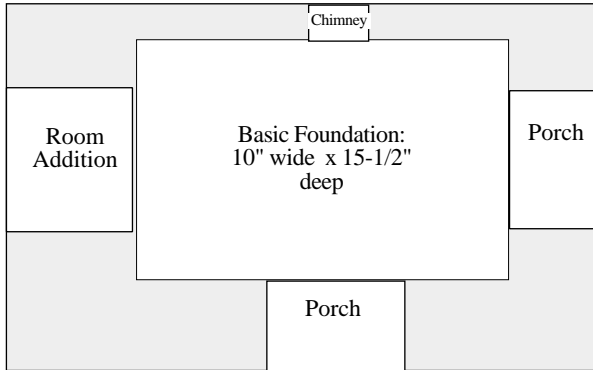

Cut From 1/4" Plywood

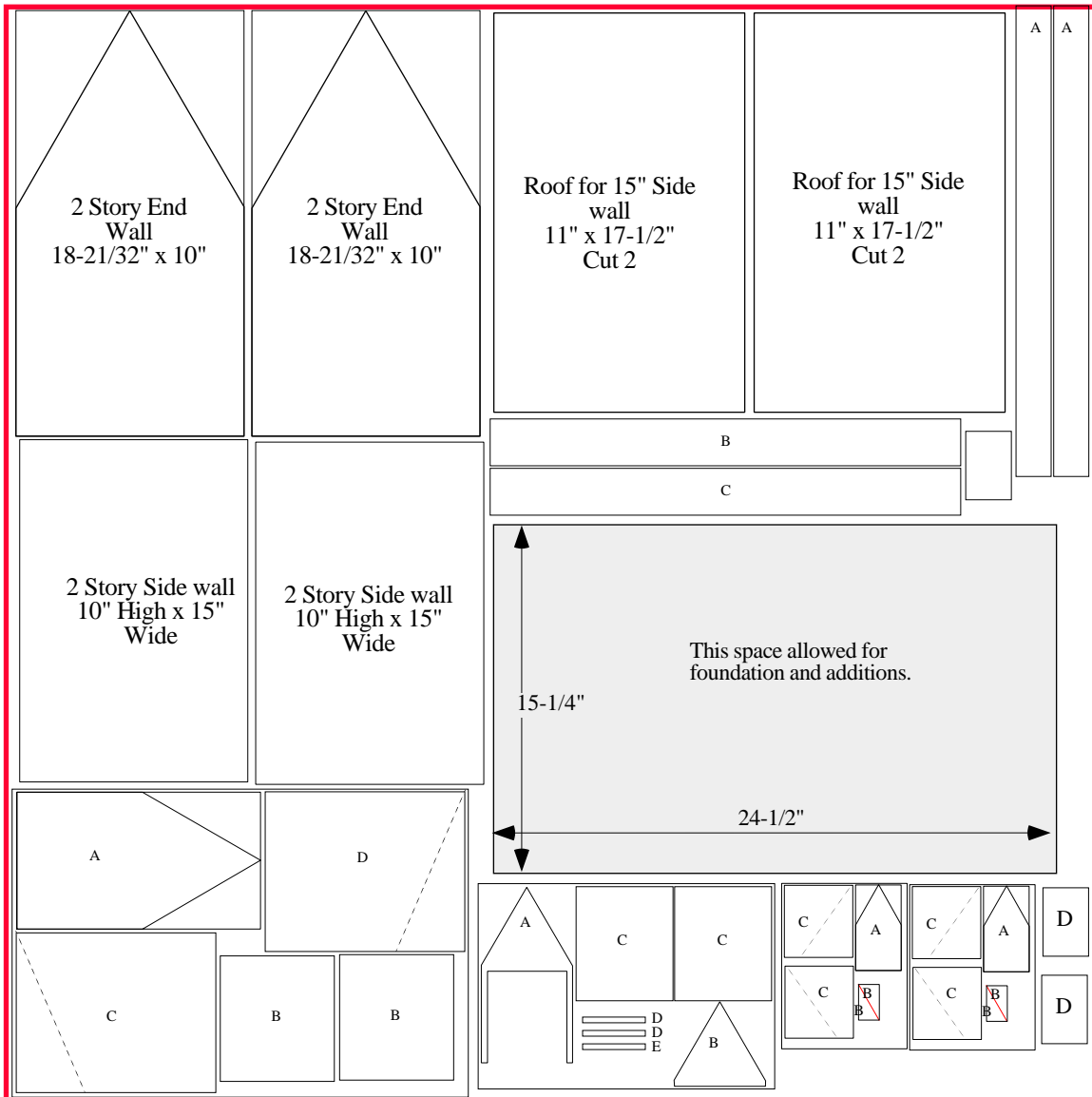

48" x 48"  
with Additions

Detail of Accessories -  
Cut from 1/4" Plywood

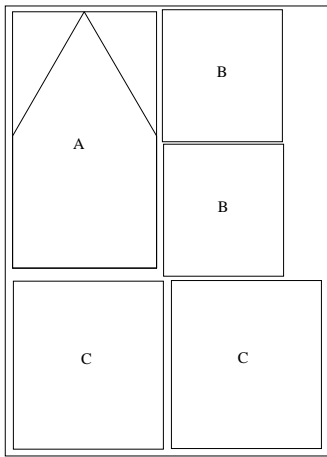

**Addition**  
18-3/4" x 13-1/2"

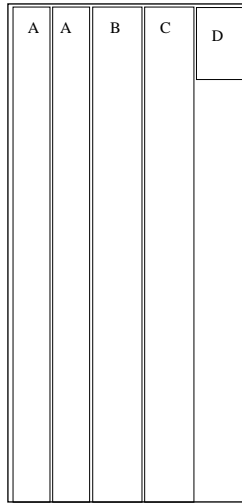

**2 Story  
Ground  
Chimney**  
20-3/4" x 10"

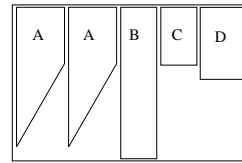

**Rooftop  
Chimney**  
6-1/2" x 10"

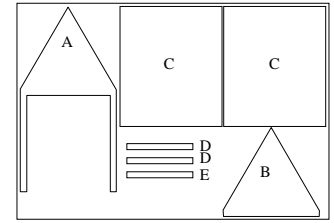

**Porch**  
9" x 13"

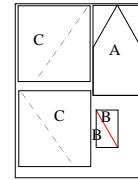

**Roof Dormer**  
7-1/4" x 5-1/4"

**The Frame - Cut from 1" Furring Strips**  
(nominally 3/4" x 3/4")

See Frame Assembly -Page 32

You will need to build a frame for which to attach the walls.

If your building will have doors which do not physically open, you can build a simple box for your wall braces. The windows and doors will fit into the walls.

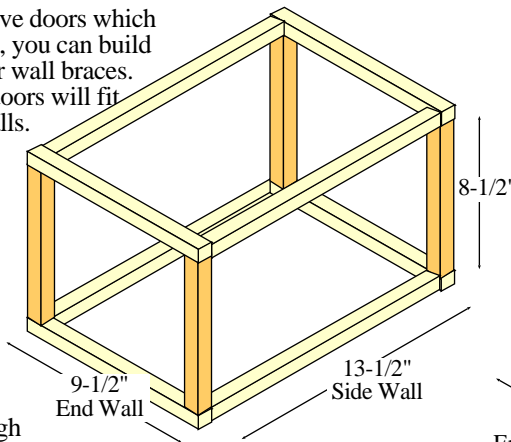

Vertical Braces for:  
2 Story Houses are 8-1/2"  
Room Additions are 4" High

If your house will have doors which do physically open, you will be cutting spaces from the bottom floor frame.

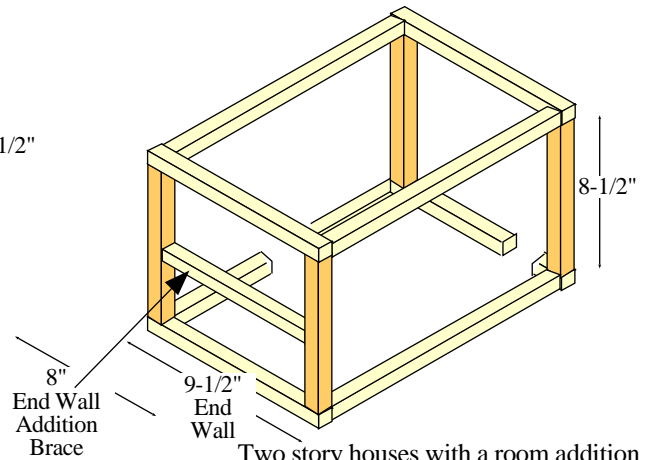

Two story houses with a room addition will need 1 extra horizontal brace.  
•End wall brace 1-1/2" shorter to fit inside the vertical frames.

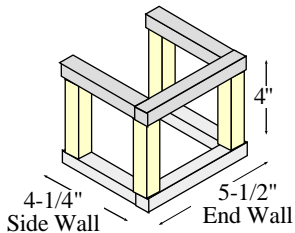

Room Addition	
4 @ 4-1/4"	17"
2 @ 5-1/2"	11"
4 @ 4"	16"
<b>**Total</b>	<b>44"</b>

**Cut furring strips as needed for your house. If your strips are not 3/4" square see Frame Layout Diagram (page 31) and Step 6 on page 33 for adjustments.**

Qty.	House Frame 1" Furring Strips
4	13-1/2"
4	9-1/2"
4	8-1/2"
Addition Frame	
1	8"
2	5-1/2"
4	4-1/4"
4	4"

**Total Furring Strips Required**

4 @ 9-1/2"	38"
4 @ 13-1/2"	54"
4 @ 8-1/2"	34"
<b>Total Basic</b>	<b>126"</b>
<b>Addition Total</b>	<b>44"***</b>
<b>Brace For Addition</b>	
1 @ 8"	8"
<b>Total</b>	<b>178"</b>

Purchase Ready Made Doors and windows or make your own from Garden Town Doors and Windows Series

Door and Window Requirements for Houses as shown on pages 14 through 16  
You may wish to add or omit windows.

House No.	Doors*	Window # 1* 1-3/4" x 2-3/4"	Dormer Windows # 6* 1-1/2" x 1-1/2"
1	2	18	Optional
2	2	16	"
3	2	14	"
4	2	19	"
5	2	15	"
6	2	15	"

**Doors and Windows**  
**Cut from 1/8" thick**  
**Balsa wood or Hardwood**

**Window Glazing**  
**8" x 10"**

\*From Garden Towns Doors and Windows, use:  
your choice of Doors 2 through 6.  
(For Door # 1 add 4" of 4" wide wood per door)  
Window # 1 basic house window  
Window # 6 if you add dormers

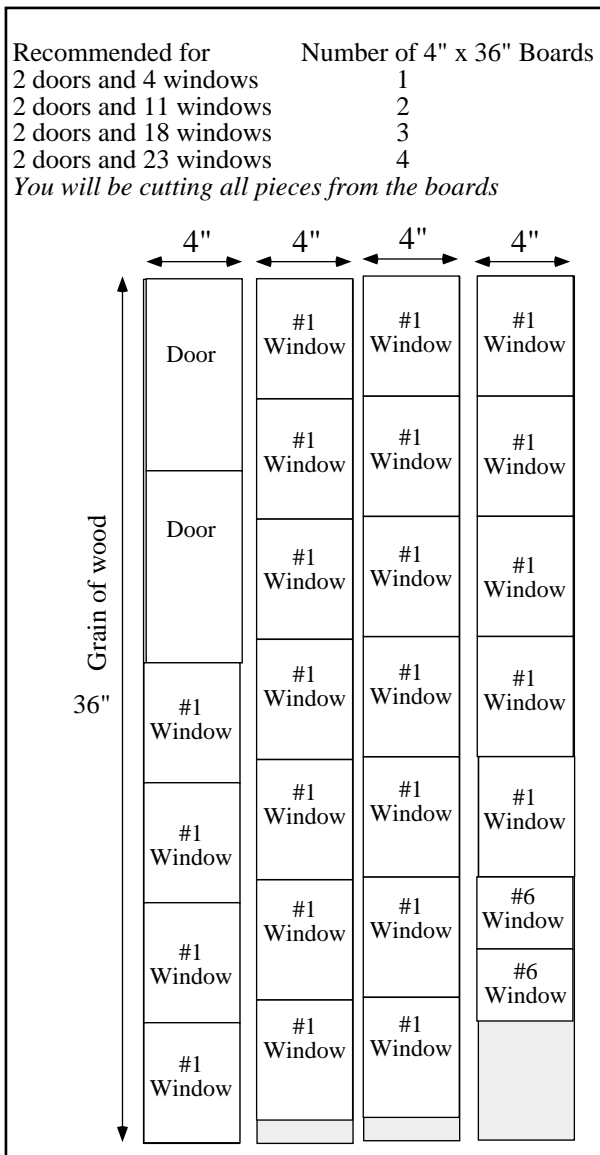

**Optional**

If you prefer to buy ready made strips

**Boards**

(2) 1/8" x 4" x 36" boards

**Strips**

- (1) 1/8" x 1/8" x 18"
- (7) 1/8" x 1/4" x 36"
- (3) 1/8" x 3/8" x 36"
- (3) 1/8" x 5/8" x 36" (shutters)

"We" personally always purchase a couple of extra boards "just in case of errors". If there's any left over, it will be there for the next project.



Areas that need to be mitered in order to fit will be designated with this icon on the pattern. The specific mitering angle is noted on the pattern page.

Roof

Illustrations are side view of roof

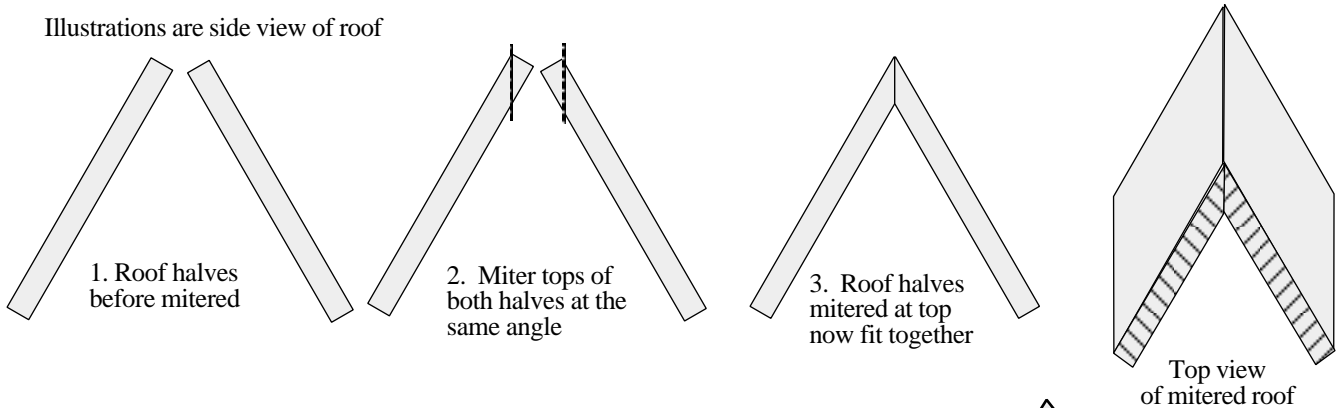

In order for the roof halves to meet at the top smoothly, you will need to miter the top edges on the inside.

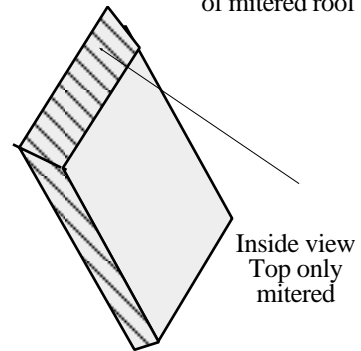

Miter at 30°

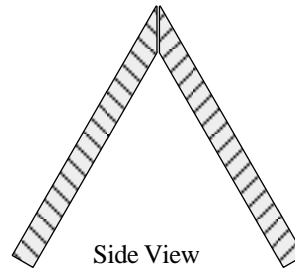
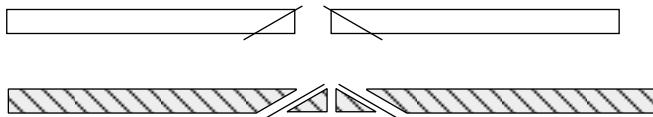

Rooftop Chimney

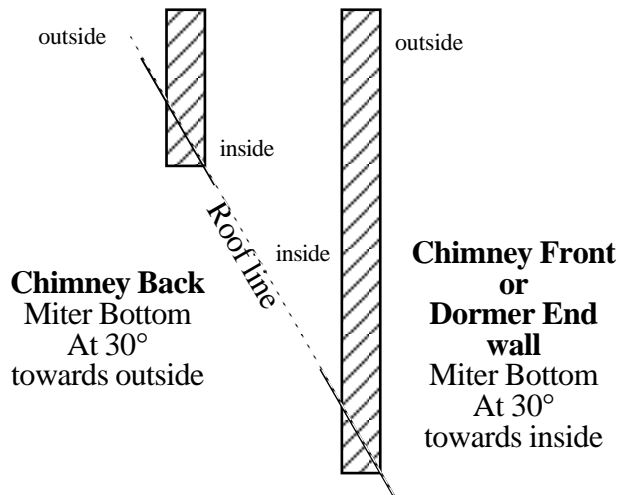



**Chimneys - Rooftop Type**

The Back is always towards the peak of the roof and is shorter than the Front to accommodate the slope of the roof.

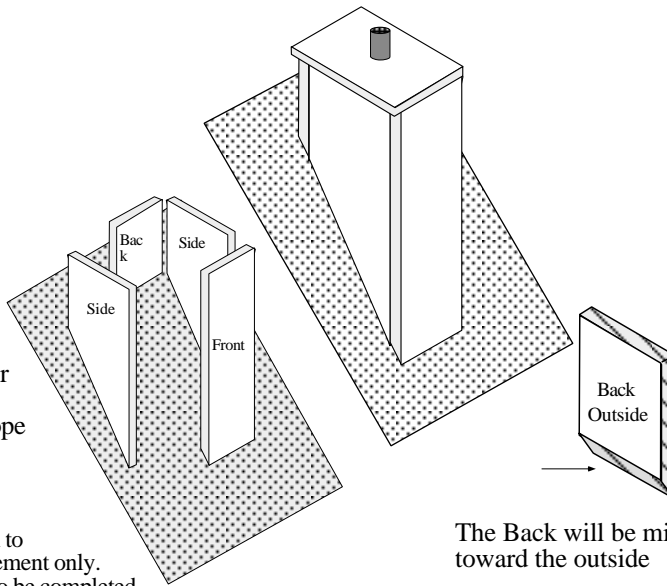
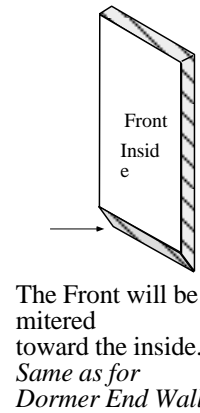

Illustration to show placement only. Chimney to be completed before attaching to roof.

The Back will be mitered toward the outside



The Front will be mitered toward the inside. Same as for Dormer End Wall

**Dormers**

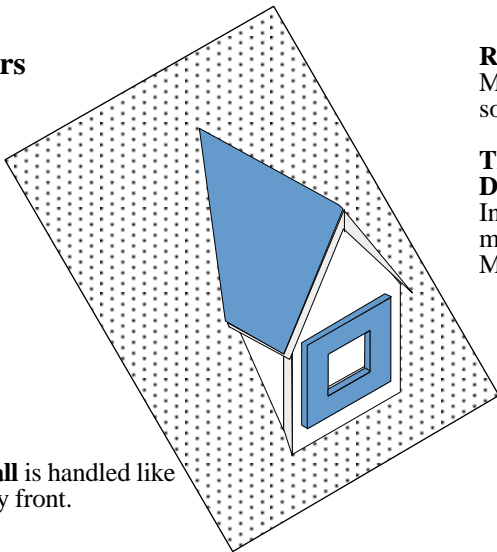

**End wall** is handled like chimney front.

**Roofs**

Miter in same manner as the main roof so that the tops will fit together smoothly.

**There is one additional step for Dormer Roofs.**

In order for the angled edge to fit onto the main roof, miter the inside of the angled edge. Miter all three sides at the same angle.

Inside view  
Dormer roof half

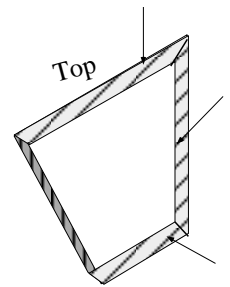

Mitered on top, angled side and bottom.

**Porches**

Any porch with an angled roof will need to be mitered in the same manner as Main roofs

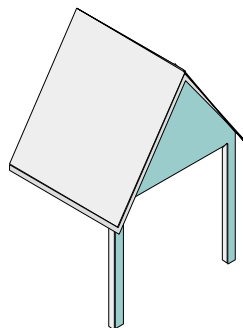

Roof halves will be mitered to fit each other at top

Scaled Walls represent actual dimensions

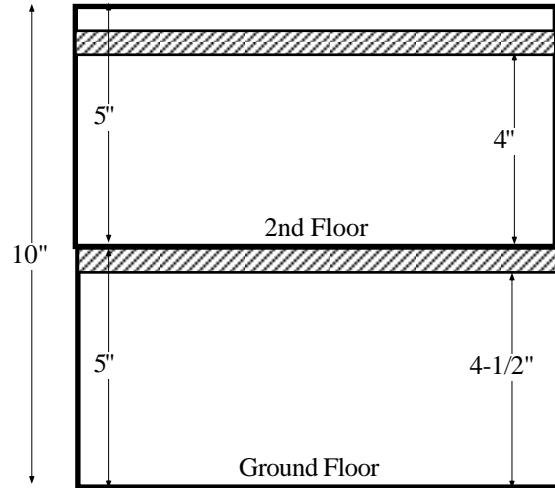

Two Story houses		
	Scaled	Represents
<u>Ground Floor</u>		
Ceiling Height	4- 1/2"	9' 0"
Ceiling Rafters	1/2"	1' 0"
Ground Floor	5"	10' 0"
<u>2nd Floor</u>		
Ceiling height	4"	8' 0"
Ceiling Rafters	1/2"	1' 0"
Attic Space	1/2"	1' 0"
Total Height	5"	10' 0"
Total 2 Story	10"	20' 0"

Window and Door Placement

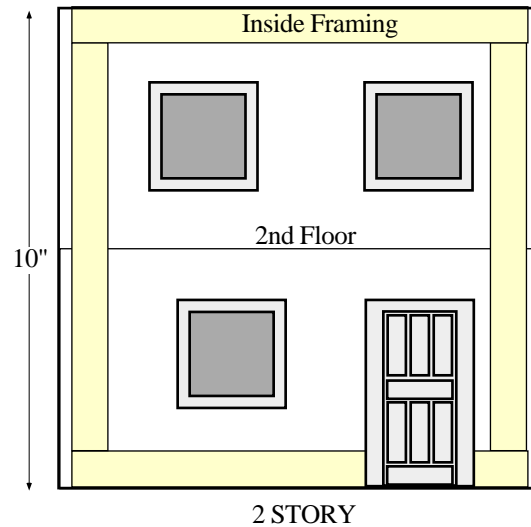

- Framing (1" Furring strips) are nominally 3/4" thick
- Doors are placed at floor line
- Windows placed with tops level with doors
- Floor line on 2nd floor will be 5" from bottom. (This line is not functional or visible)
- Windows and doors have to be at least 1" from sides and top (to clear inside building frame)

Houses illustrated show walls which make up the house. Basic walls have no extension on the foundation, such as ground chimney, room addition or porch. You may choose to switch walls on your house. (You may prefer an end door instead of a side door.) There will be no foundation adjustment as long as you replace one basic wall with another.

House 1

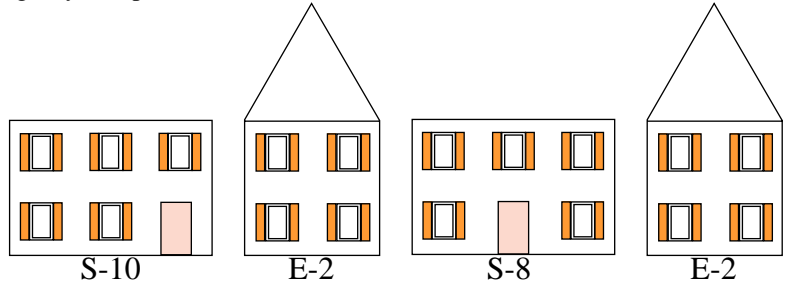
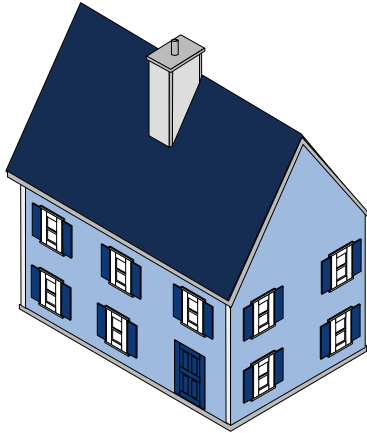

Use Walls 2, 3 or 5  
on any straight end wall

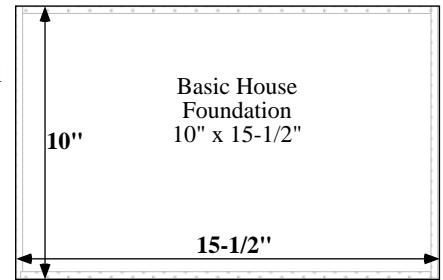

Use Walls 7,8 or 10  
on any straight side wall

**Cut foundation from 1/4" Plywood**

**House No. 1 Basic Foundation**

Use the Basic Foundation for houses which do not have a ground chimney, room addition or porch.

10" x 15-1/2"

House 2

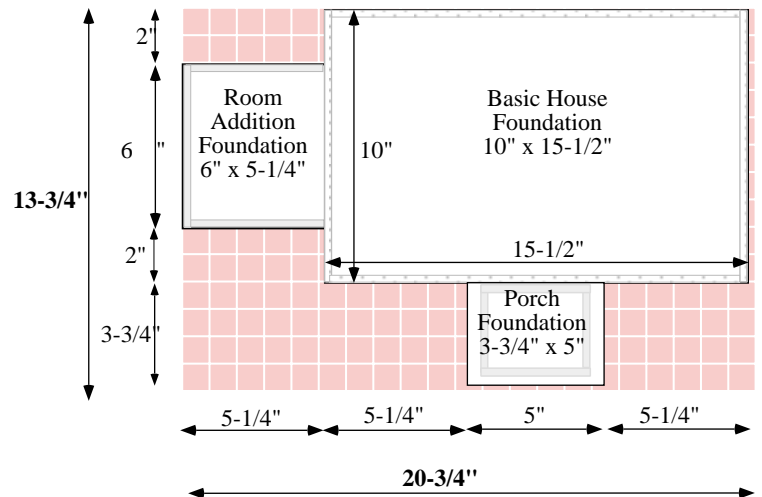
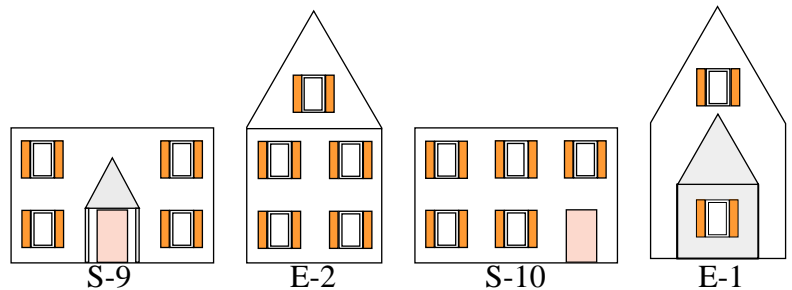
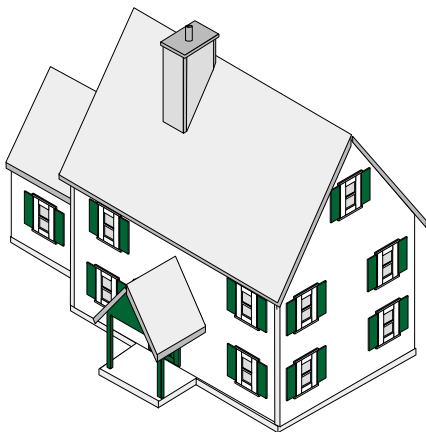

**House No. 2**

13-3/4" x 20-3/4"

**Cut foundation from 1/4" Plywood**

House 3

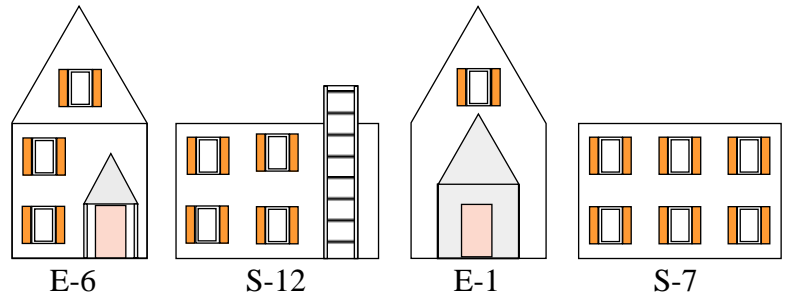
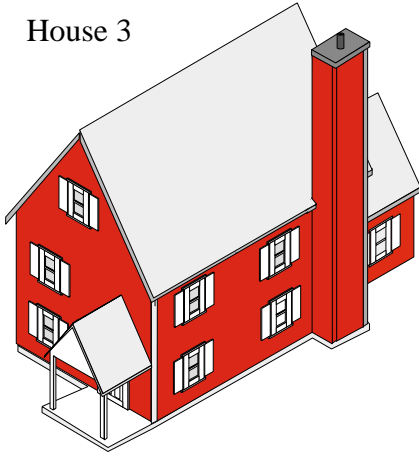

**Cut foundation from 1/4" Plywood**

**House No. 3**  
11-1/2" x 24-1/2"

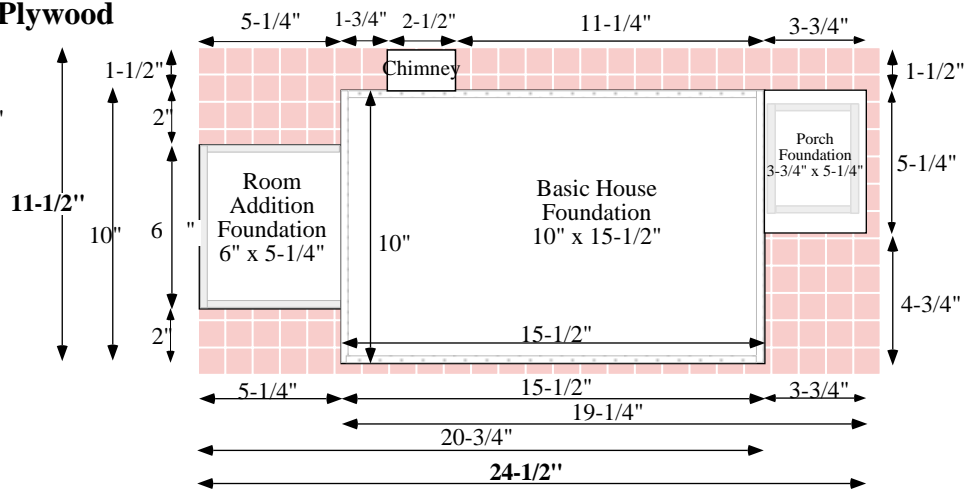

To Build the House  
without a ground chimney  
begin with rectangle  
10" x 24-1/2"

House 4

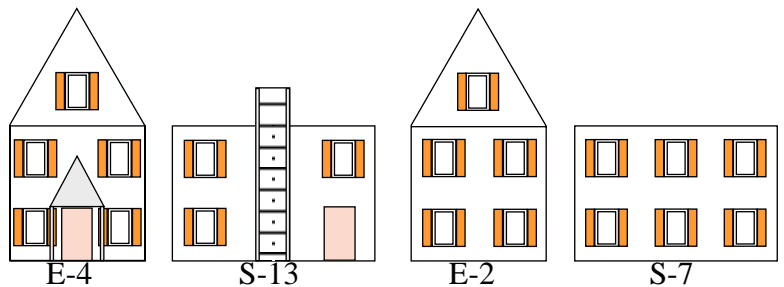
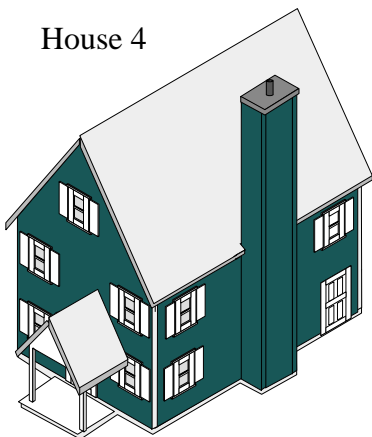

**Cut foundation from 1/4" Plywood**

**House No. 4**  
11-1/2" x 19-1/4"

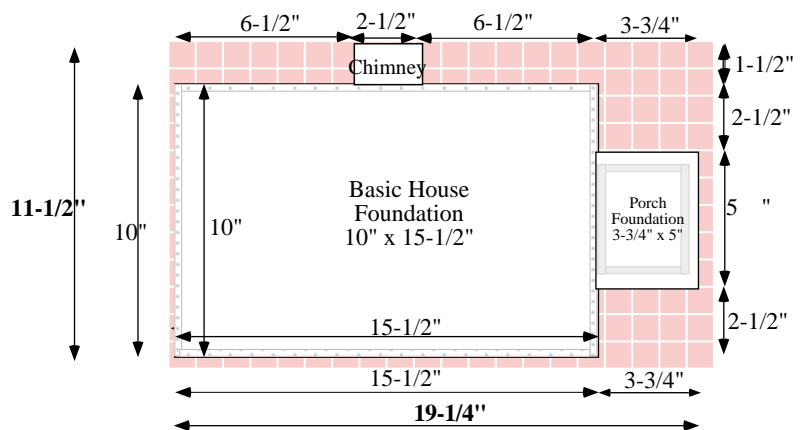

To Build the House  
without a ground chimney  
begin with rectangle  
10" x 19-1/4"

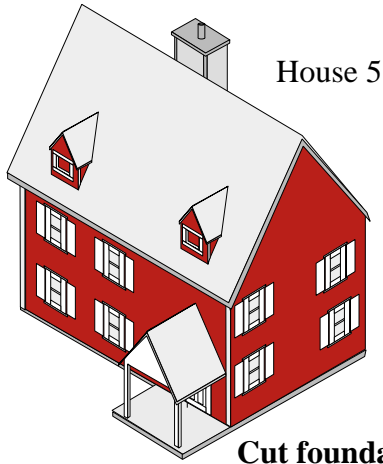

**House 5**  
**Cut foundation from 1/4" Plywood**

**House No. 5**  
15-1/4" x 15-1/2"

To Build the House  
without a ground  
chimney  
begin with rectangle  
13-3/4" x 15-1/2"

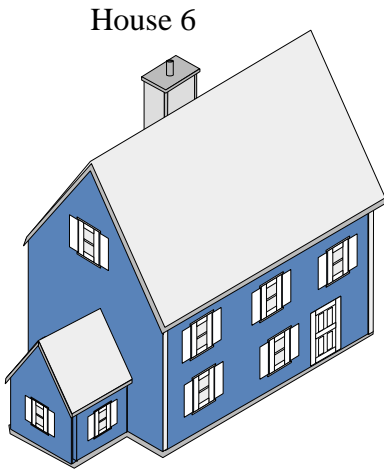
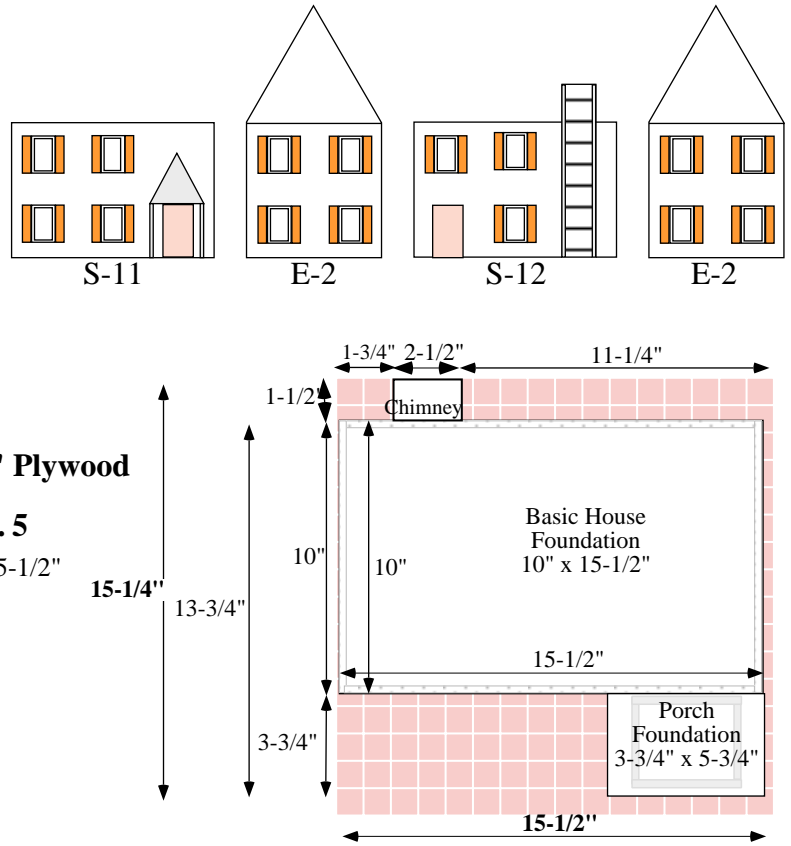

**House 6**  
**Cut foundation from 1/4" Plywood**

**House No. 6**  
11-1/2" x 20-3/4"

To Build the House  
without a ground  
chimney  
begin with rectangle  
10" x 20-3/4"

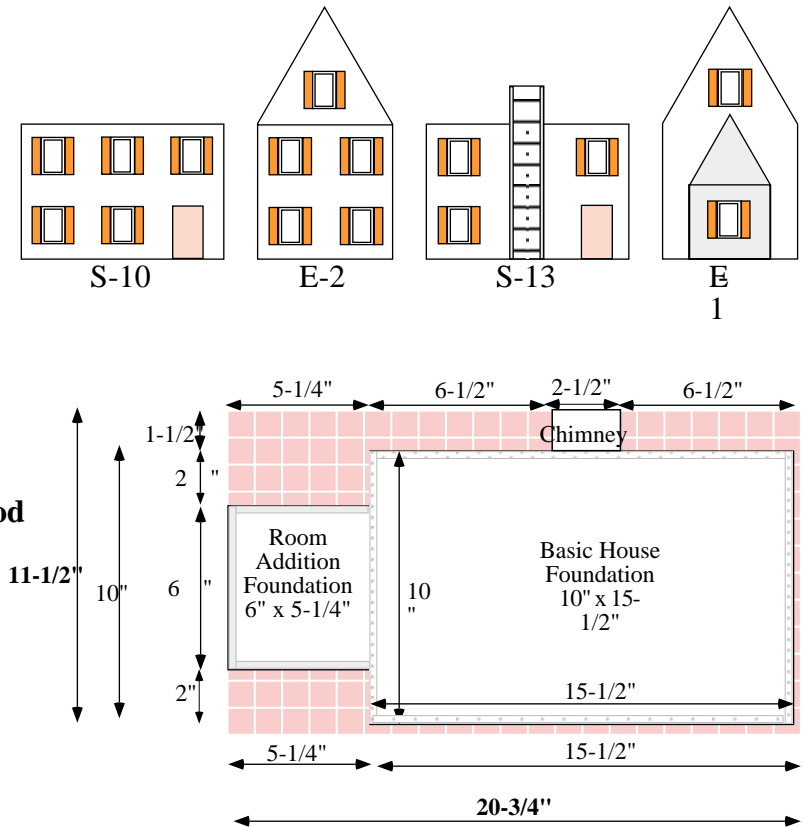

**End Walls**

**Cut from 1/4" Plywood**

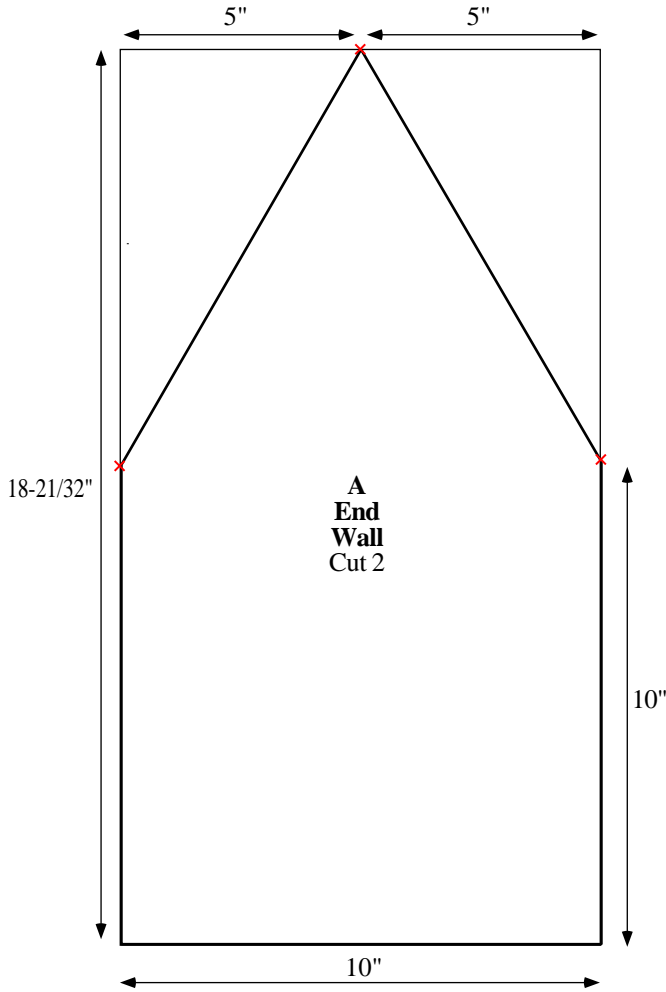

- End Wall  
Begin with a rectangle 18-21/32" High x 10" Wide
- Measure and mark the top center (5" from each side)
  - Measure and mark 10" up from the bottom on both sides
  - With ruler, draw your lines between the x's. This forms the roof line
  - Cut out two End Walls

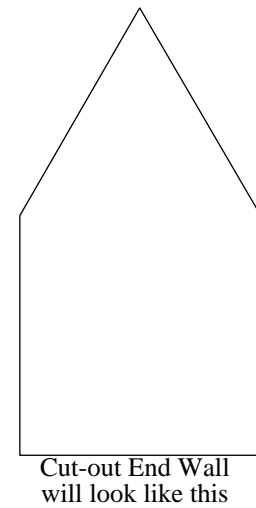

Cut-out End Wall will look like this

**Side walls**

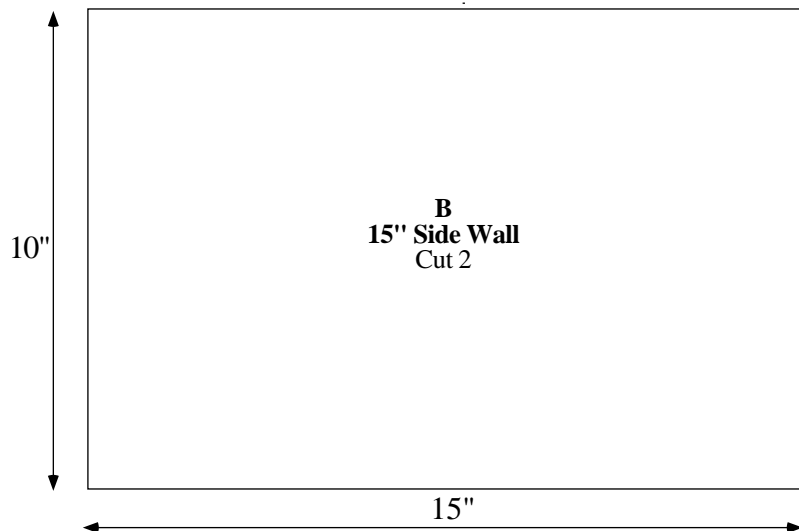

Cut from 1/4" Plywood



Plain Roof Halves  
for Walls with no Chimney

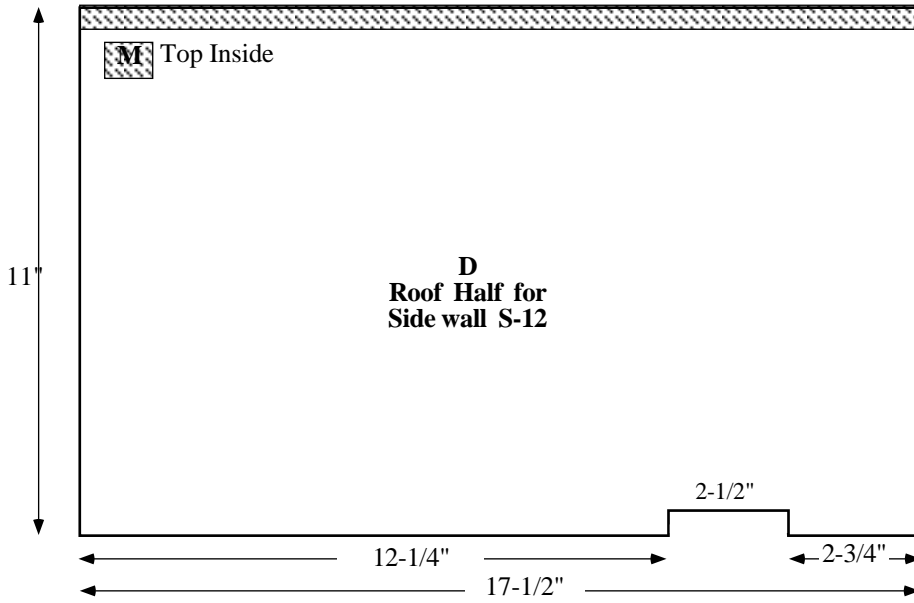
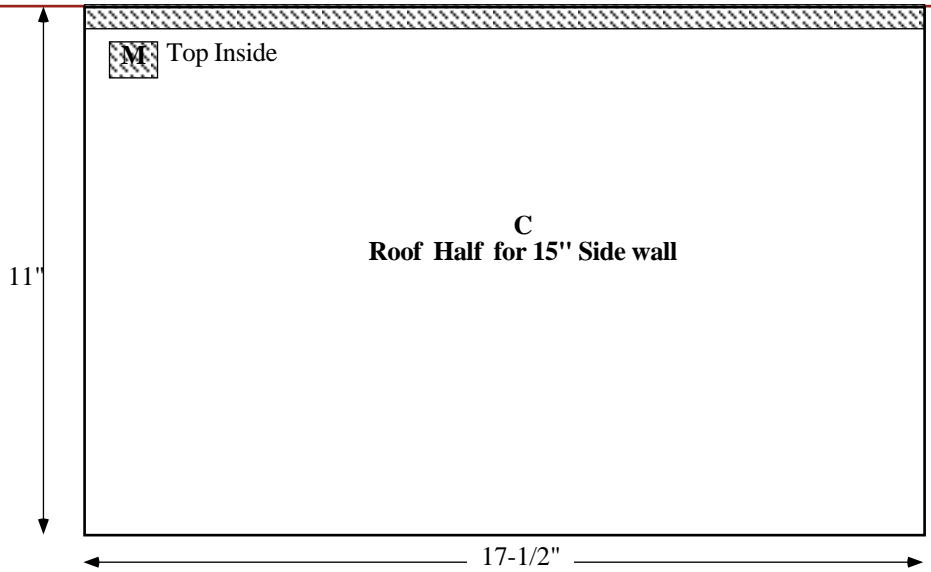

Roof Half for Side wall  
with offset Ground Chimney

Make the notch 2-1/2" wide and 1/2" deep.  
You may have to trim a bit more when  
actually fitting your chimney in place.

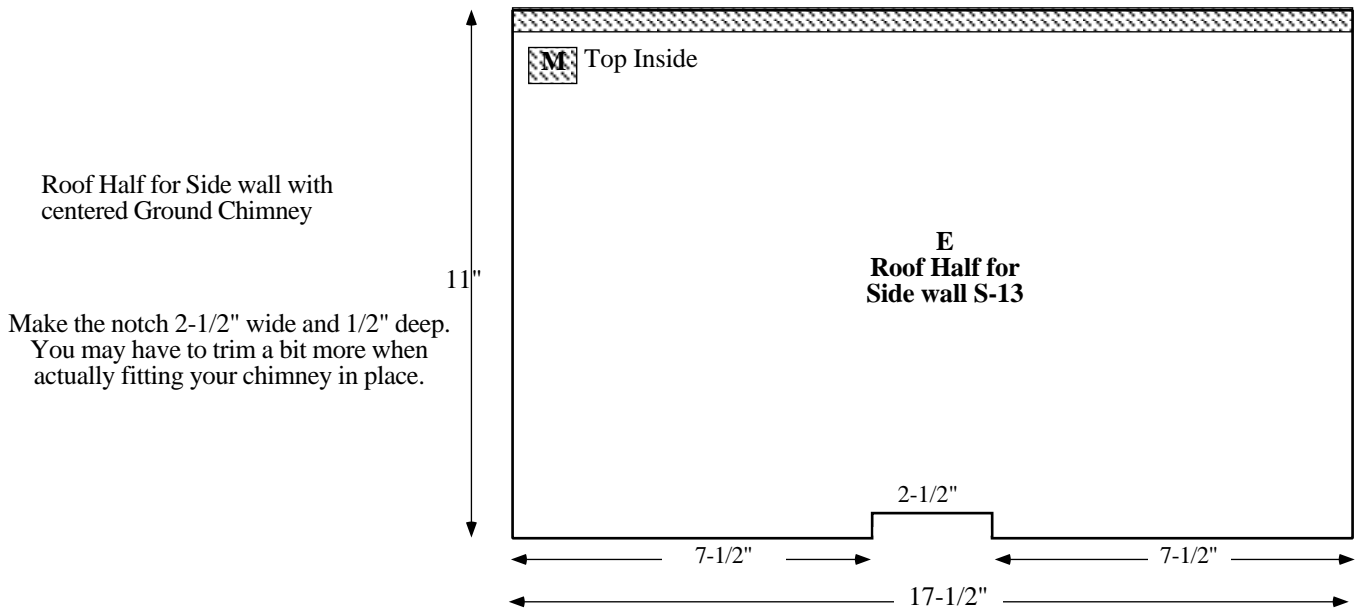

Roof Half for Side wall with  
centered Ground Chimney

Make the notch 2-1/2" wide and 1/2" deep.  
You may have to trim a bit more when  
actually fitting your chimney in place.

**Cut from 1/4" Plywood**

**Room Addition  
End Wall**

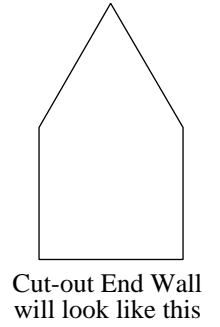
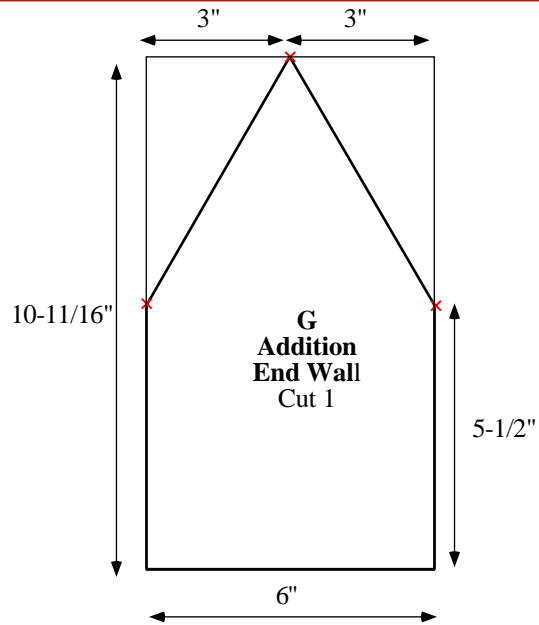

- End Wall**  
Begin with a rectangle 10-11/16" High x 6" Wide
- Measure and mark the top center (3" from each side)
  - Measure and mark 5-1/2" up from the bottom on both sides
  - With ruler, draw your lines between the x's. This forms the roof line.
  - Cut out 1 End Wall

**Room Addition  
Side Wall**

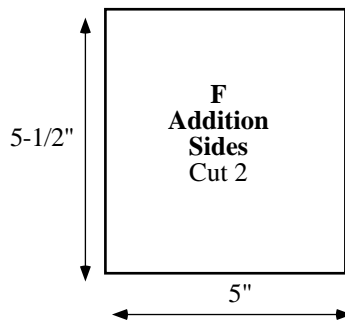

**Room Addition  
Roof**

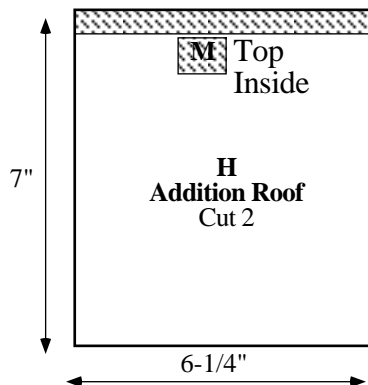



**Important Note:** Measurements shown in the wall illustrations are from a point to window or door frame. They are not the cutting lines for window or door openings.

Mark the measurements on your walls. Then use the corresponding window or door templates which will show where to cut the opening or place the door. Details on page 21.

Doors and windows illustrated are the following dimensions. If you use windows of a different size, adjust your guide lines if necessary. Remember you need 1" clearance on each side and the top to avoid cutting into the framing.

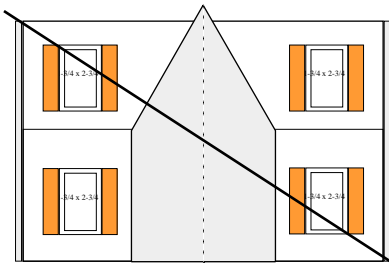
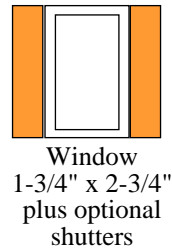
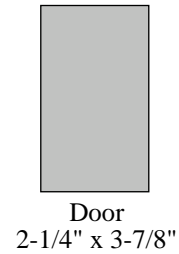

Room Addition can not be added to a Side Wall

Room Addition  
End Wall  
6" wide

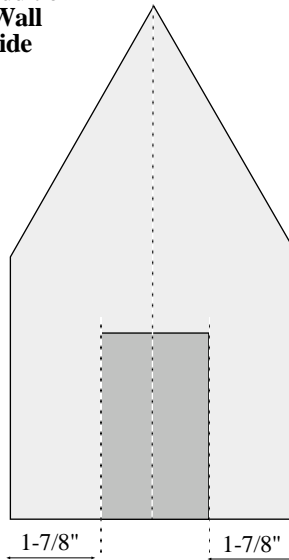

End wall with optional Door

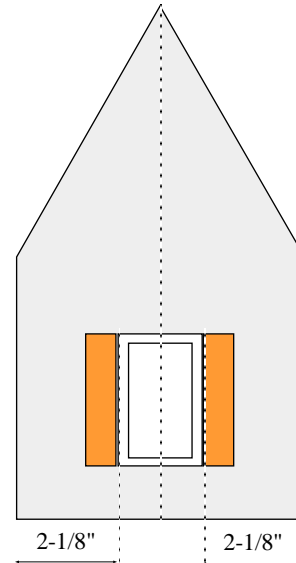

End wall with optional Window

Room Addition  
Side Wall  
5" wide

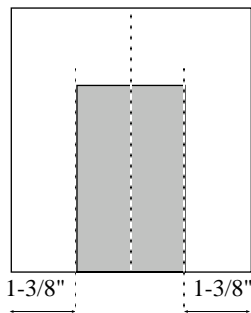

Side wall with optional Door

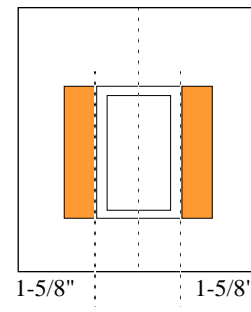

Side wall with optional Window

End Walls

End Wall with Room Addition. Windows will not fit onto the house end walls except the peak.  
See Room Addition Walls for options.

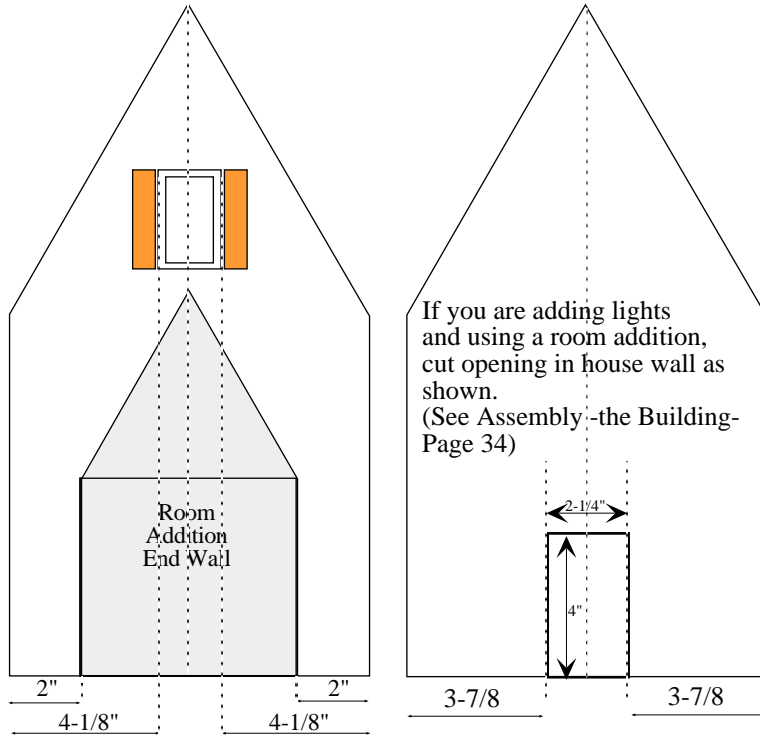

If you are adding lights and using a room addition, cut opening in house wall as shown.  
(See Assembly -the Building- Page 34)

**E-4**  
Drill 2 very small pilot holes to attach the porch back. Holes will be centered at 5" from each side and  
(1) at 4-3/4" above floorline  
(1) at 6-1/2" above floorline

**E-1**  
Common Wall

**Note: The top attic window is optional on all end walls.**

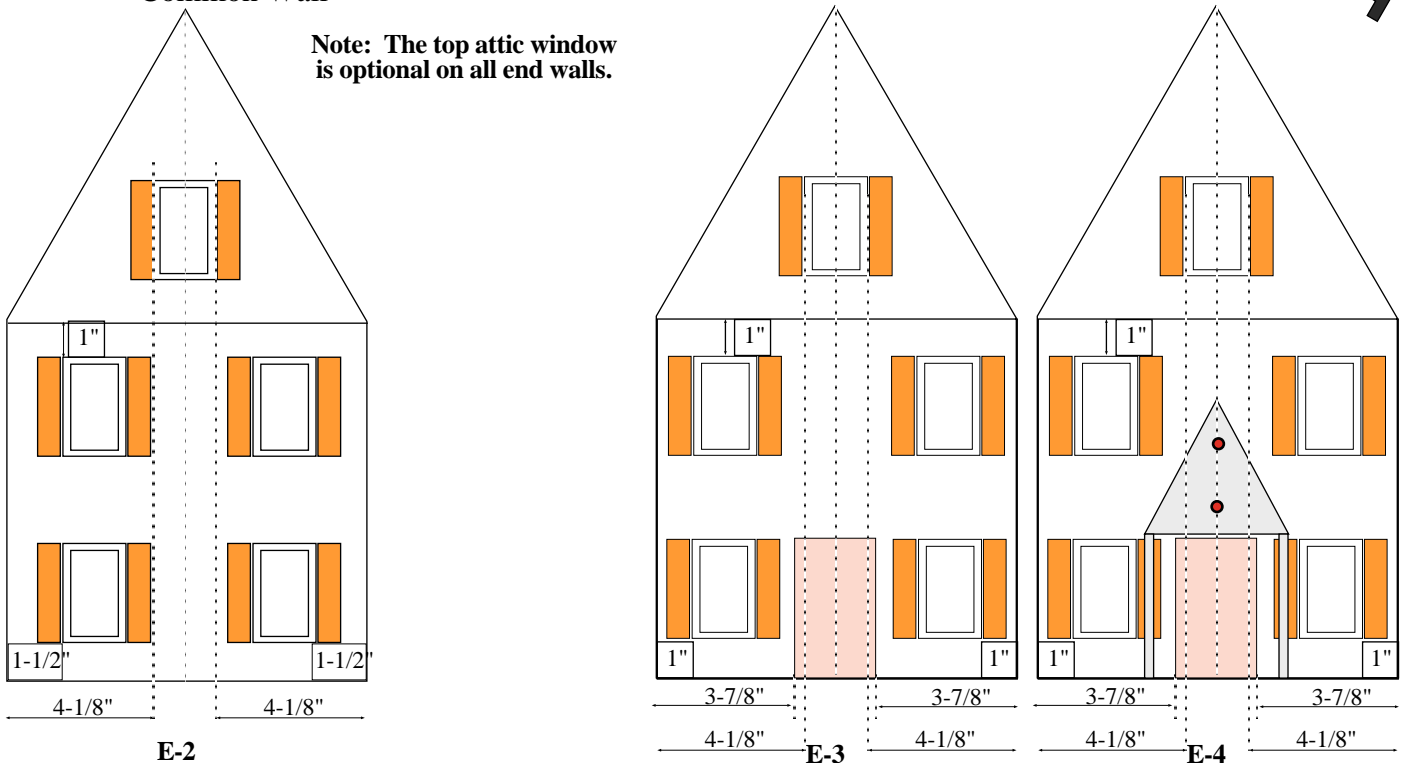

**E-2**  
Wall with all windows.  
Choose as many windows as you wish.

**E-3**  
Door Centered

**E-4**  
Door Centered with Porch

End Walls

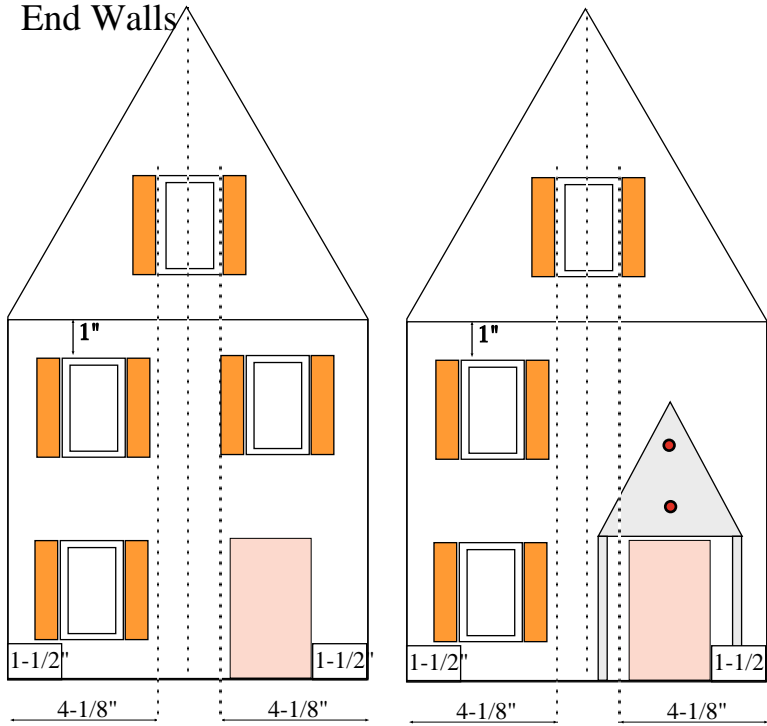

**E-5**  
Door to Side

**E-6**  
Door to Side with Porch  
Can not have window above the porch

Side Walls

Use Roof Half C for this wall

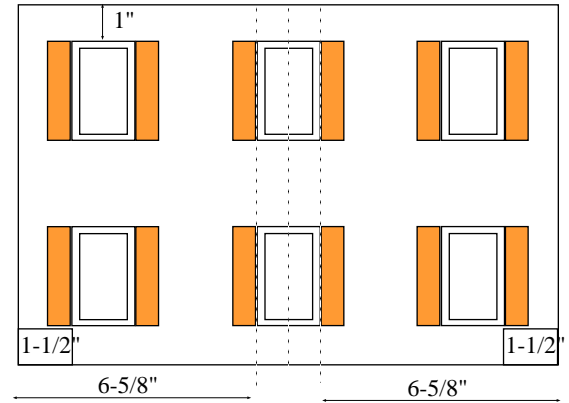

**S-7**  
All Windows  
Use any number of windows you choose

E-6

Drill 2 very small pilot holes to attach the porch back. Holes will be placed at 2-5/8" from the side and  
(1) at 4-3/4" above floorline  
(1) at 6-1/2" above floorline

Side Walls

S-9

Drill 2 very small pilot holes to attach the porch back. Holes will be centered at 7-1/2" from each side and  
(1) at 4-3/4" above floorline  
(1) at 6-1/2" above floorline

Use Roof Half C for this wall

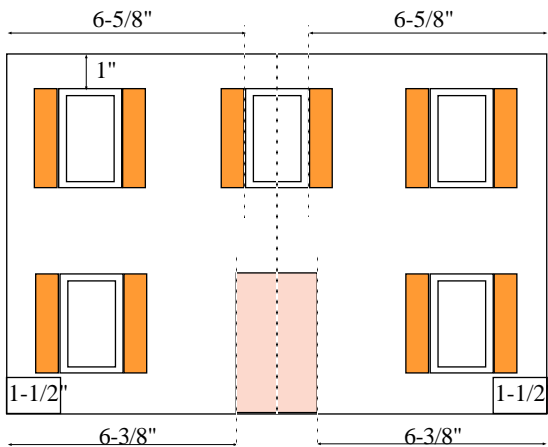

**S-8**  
Door Centered  
with optional top  
centered window

Use Roof Half C for this wall

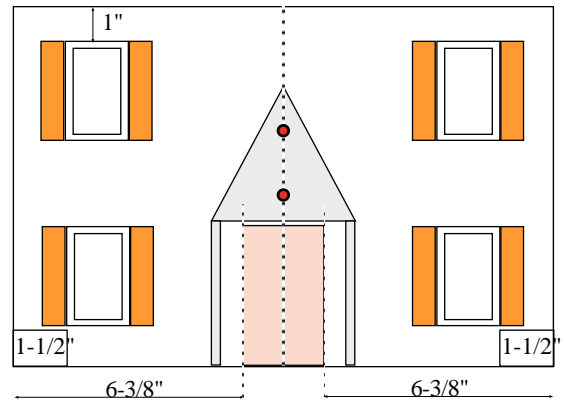

**S-9**  
Door Centered with Porch  
Can not have top center window.

Side Walls

Use Roof Half C for this wall

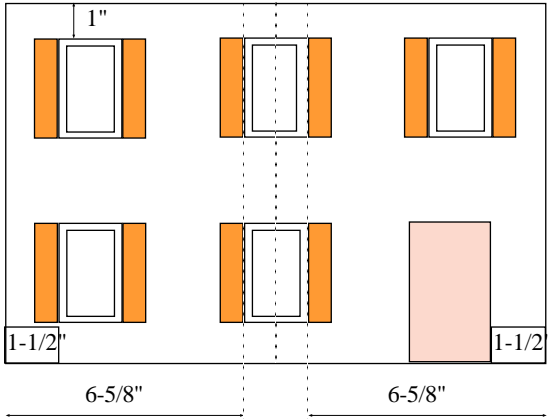

**S-10**  
Door to Side .

Use Roof Half C for this wall

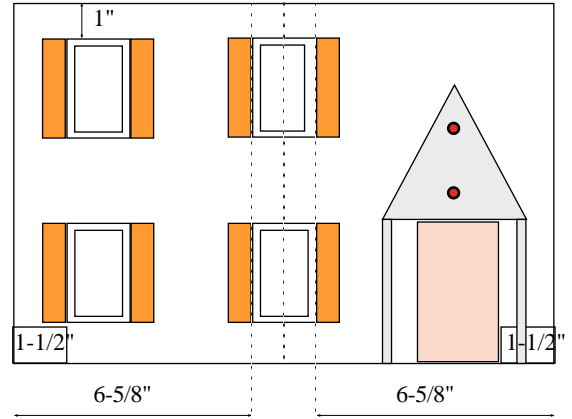

**S-11**  
Door to Side with Porch  
Can not have window above porch.

S-11  
Drill 2 very small pilot holes to attach the porch back. Holes will be placed at 2-3/4" from the side and  
(1) at 4-3/4" above floorline  
(1) at 6-1/2" above floorline

Note:  
Neither full roof height nor chimney height are shown

Use Roof Half D for this wall

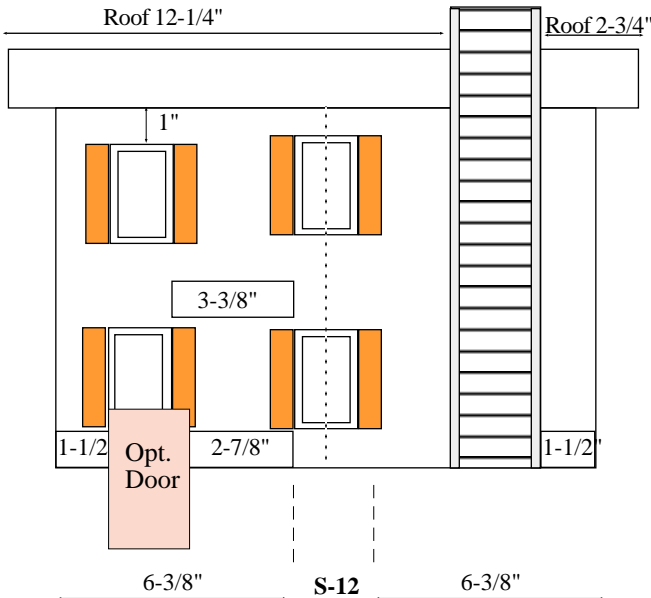

**S-12**  
Side Wall with Chimney to the side.  
Use window or door on ground floor

Use Roof Half E for this wall

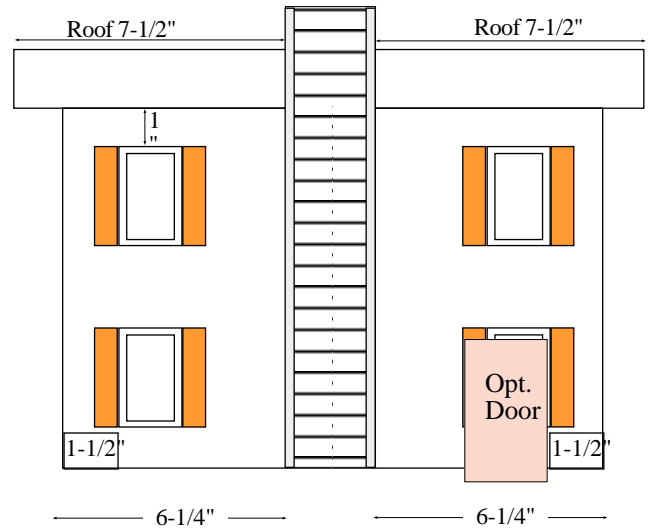

**S-13**  
Side Wall with Chimney centered.  
Use window or door on ground floor

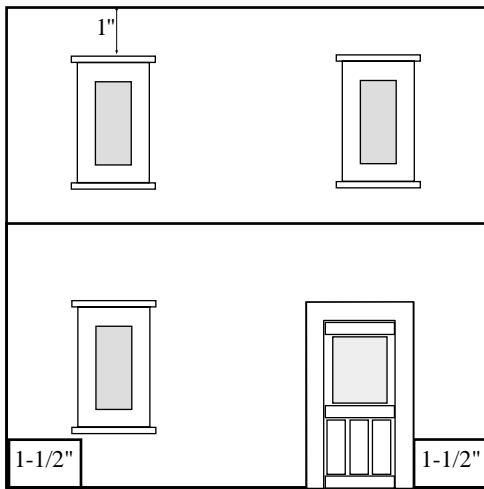
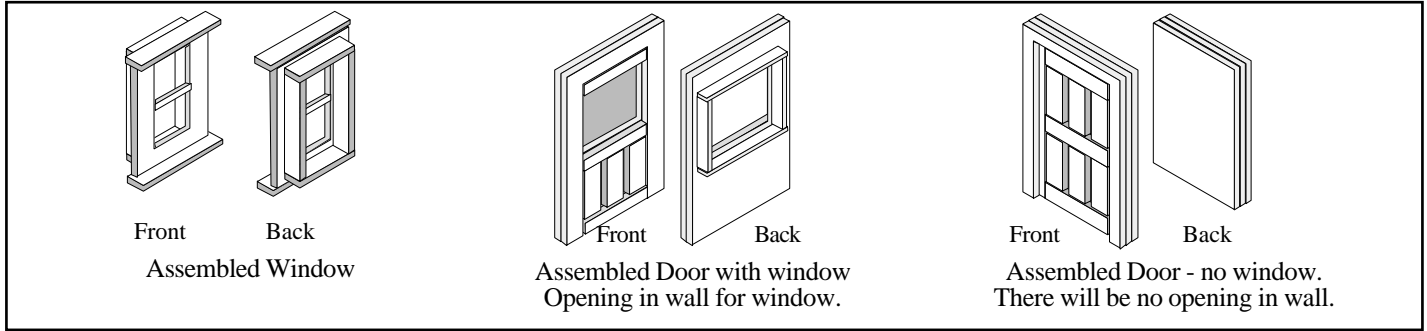

Decide where you want to place door and windows on the cut-out wall

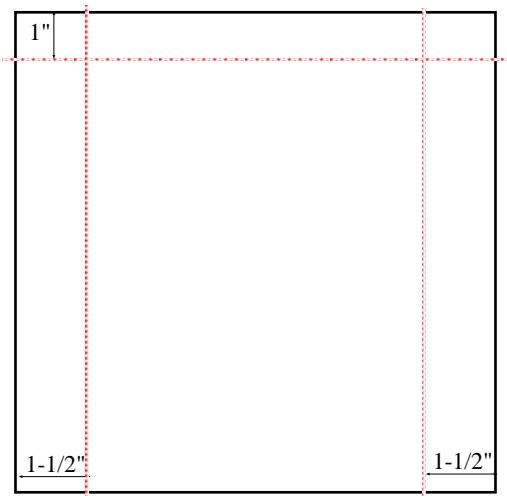

With pencil and ruler, lightly draw guide lines on the wall. you will need the 1" horizontal line for a 2 story with windows on the upper floor

Important: After you cut your template, check that the sizes and openings are accurate. Use a ruler to check. You can take a finished window or door and make sure that it fits into the template opening.

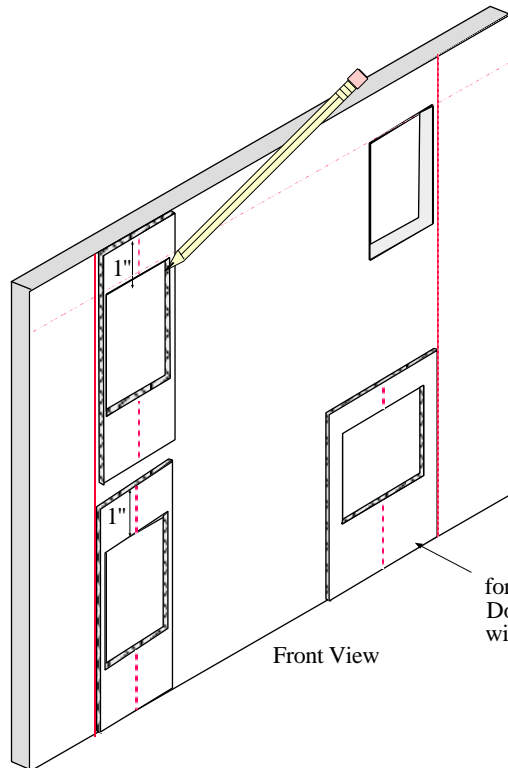

### Template for Window Opening in Wall

Using your side guide lines, place the template as follows.

**Ground floor:**

Bottom of template will be on bottom of wall

**2nd floor**

Top of template will be on top of wall

Using template and pencil, mark the window opening on the building. Cut out opening on building.

The opening is now ready for the finished window.

(Note: Door should be painted or stained before you actually insert and secure it into the building)

Note: Before installing windows, check to see that they will easily fit the wall openings. Trim openings if necessary.

House should be assembled prior to installation of windows and doors.  
We also suggest painting the house first.

Place some wood glue on the flat backs of the finished window and door with window. (around the frame) This will adhere to the front of the wall.

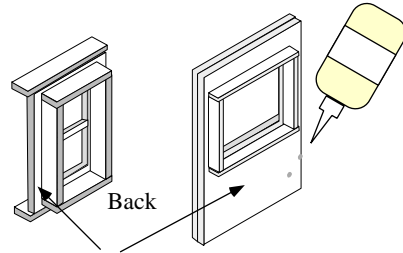

Insert the glued window or door with window into the appropriate wall opening. Look at the front side and using a level, make sure the window is straight. Run a bead of wood glue around the window brace. Allow the glue to dry.

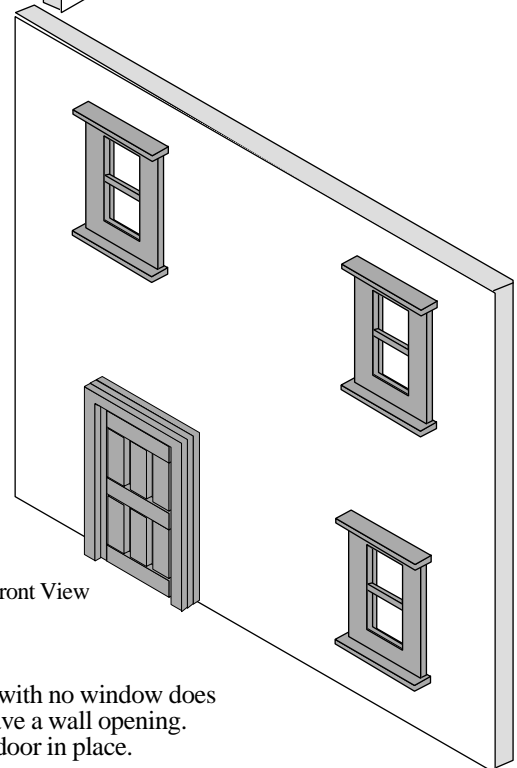
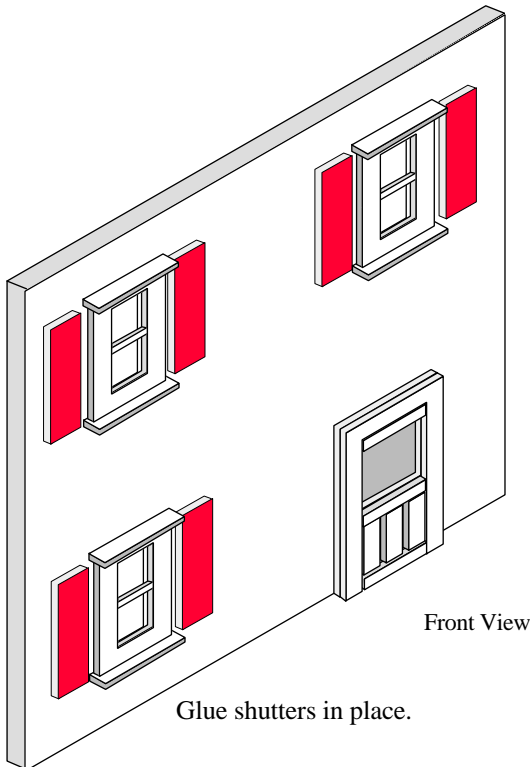
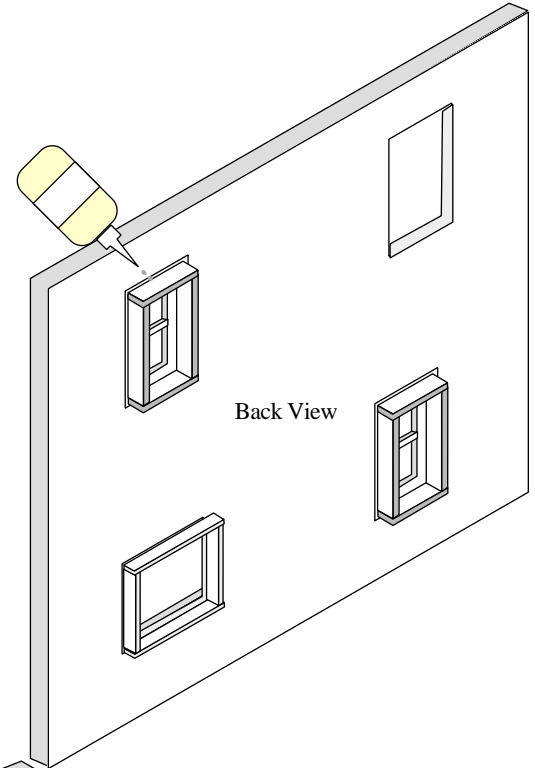

Accessories  
Chimneys

**Roof top Chimney**

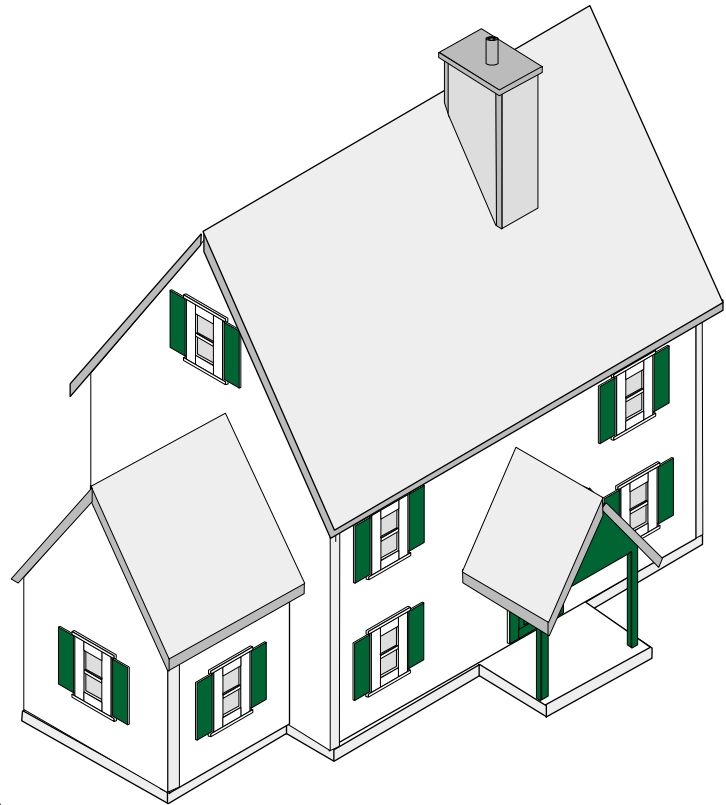

**Ground Level Chimney**

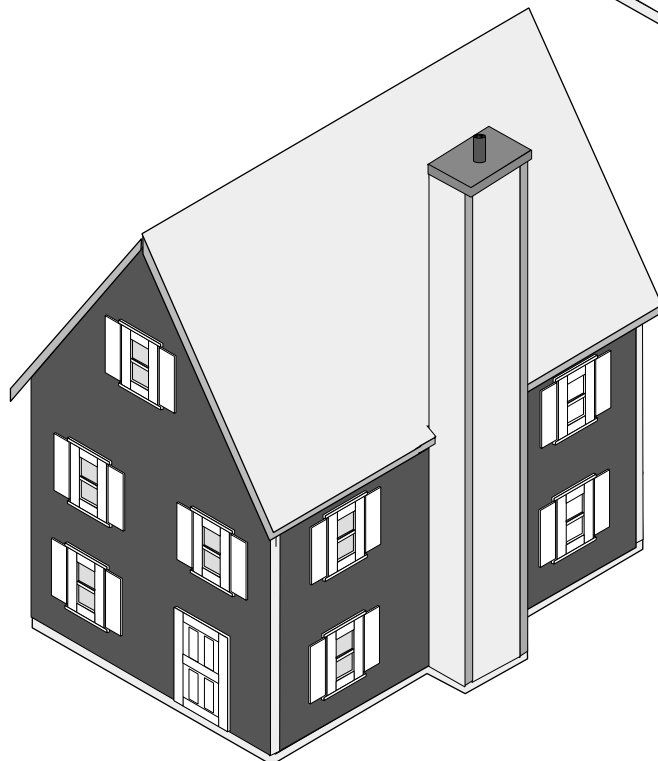

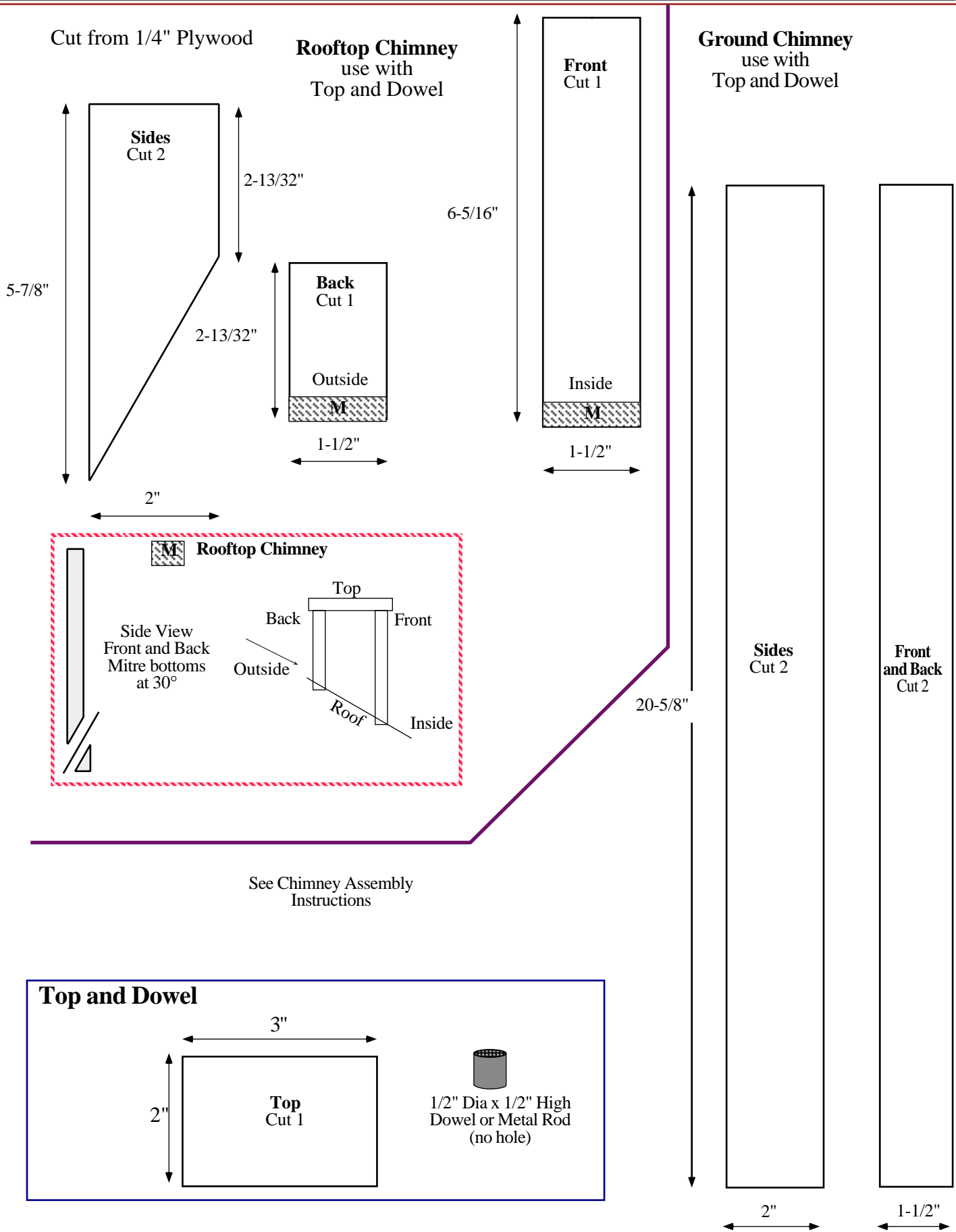



**Chimney Assembly**

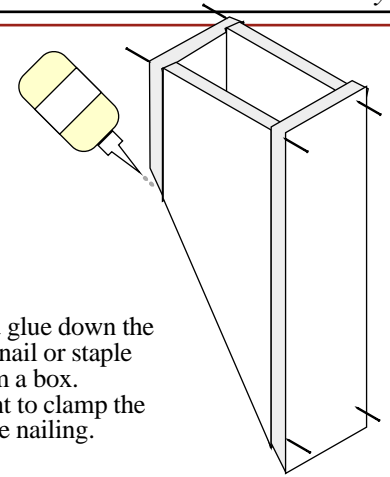
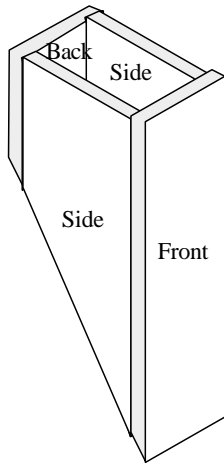
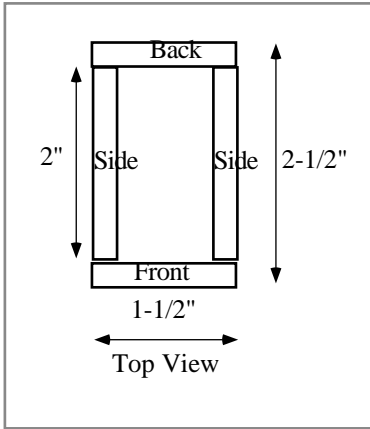

Run a bead of wood glue down the seams and securely nail or staple the chimney to form a box.  
Hint: You may want to clamp the wood in place before nailing.

Note that the Sides are assembled inside of the Front and Back. This will form a 1-1/2" x 2-1/2" chimney.

**Top**

2" X 3" with 1/2" diameter x 1/2" high dowel or metal rod (no hole) painted black.

*If building is to be used outside, you won't want rain water to run down a hole into the chimney.*

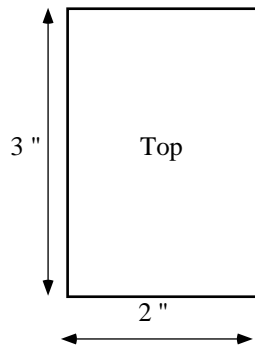

The Top will have an overhang of 1/4" on all sides.

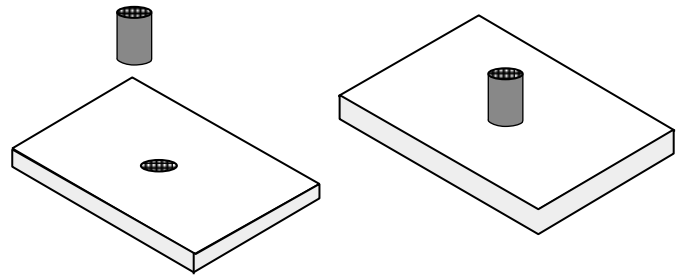

Drill a 1/2" hole in the center of the chimney top. Check to see that the rod will fit. It should be tight. Place a dab of glue inside the rim of the hole and insert rod.

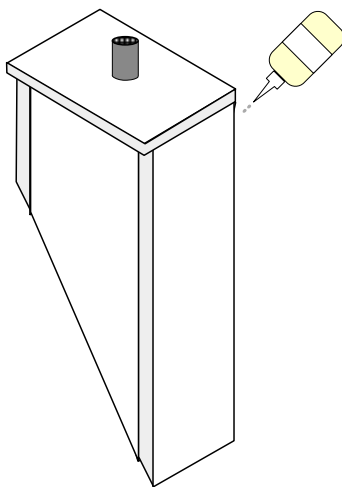

Center and add the Top to the Chimney walls. Glue in place.

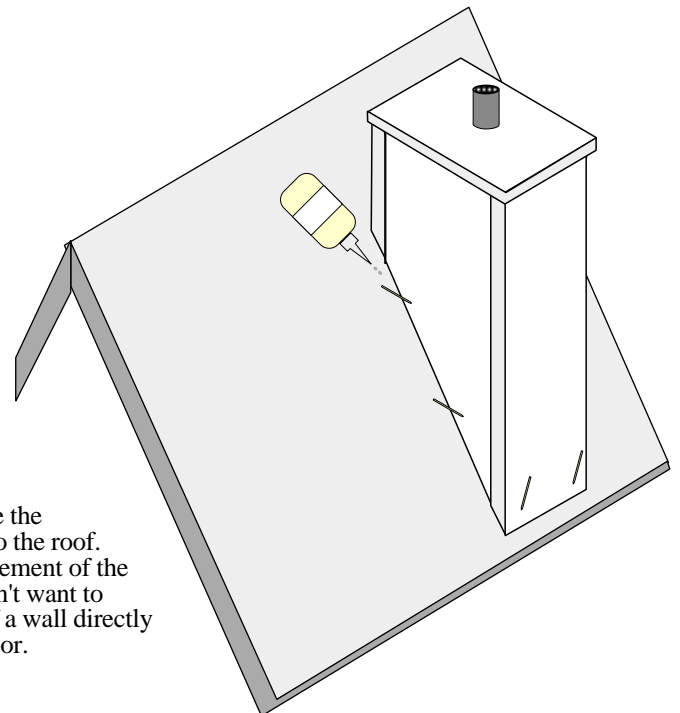

Glue and nail or staple the completed chimney to the roof. Keep in mind the placement of the chimney. You wouldn't want to place it on the edge of a wall directly above a window or door.

### Ground Level Chimney

The ground level chimney is assembled exactly the same as the rooftop chimney except that there is no mitering.

In order to get the chimney to fit up against the building, you will have to cut out a space on your roof for the chimney to slide into. Use the appropriate roof half (D or E) for the chimney side.  
Cut out the notch before assembling the roof. The notch will be in the same position vertically as the foundation addition for the chimney.

The notch will be 2-1/2" wide (width of the chimney) x 1/2" deep (or the depth of the overhang.) You may have to trim a little off to get a snug fit.

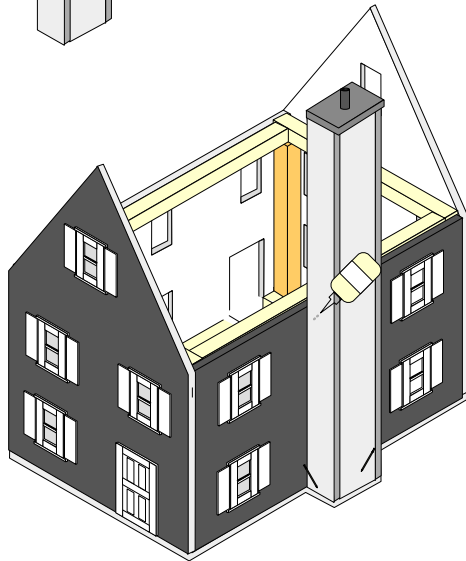
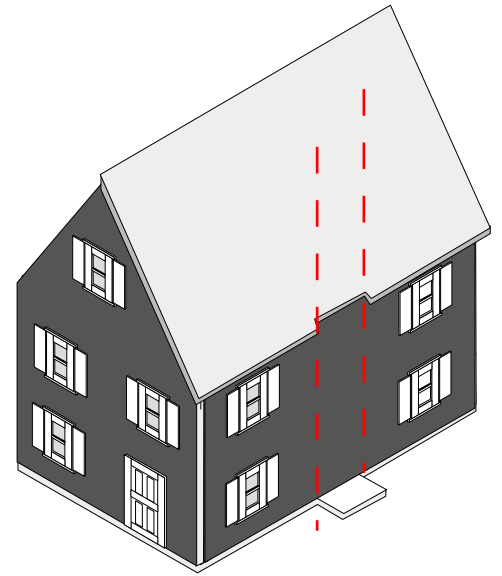
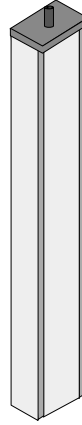
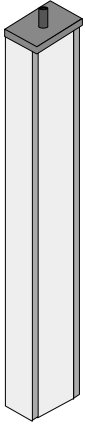

The Chimney should be installed against the house before attaching the roof. Use your wood glue and nail or staple chimney in place to the side walls (from inside of house) and the foundation.

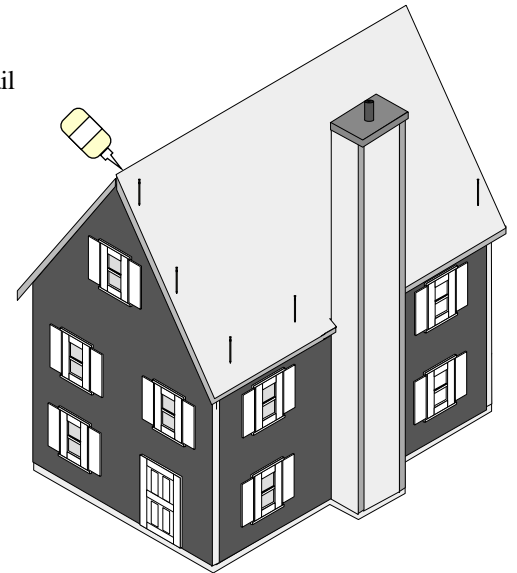

Experiment with some scrap pieces before you begin on your chimney.

### Optional ideas

1. If so inclined, you could use a bit of ready mix concrete (just add water) which is usually used for patching. Rough up the sides and the top of the chimney and cover them with a thin film of the concrete. You may have to let it dry and go over it a couple of times in thin films to build up the desired layer. The top could be "flat" (no pattern) You can use an old sponge, brush, towel or whatever to brush the damp concrete for a rough finish or a specific pattern. The concrete can be painted or left natural.

2. Gather up some small stones or pebbles of like sizes and using epoxy, attach them to the chimney sides. Fill in the "gaps" with a thin layer of concrete, let dry for a little bit and brush the residue off the stones before it hardens. Cover the top piece with a layer of the concrete.

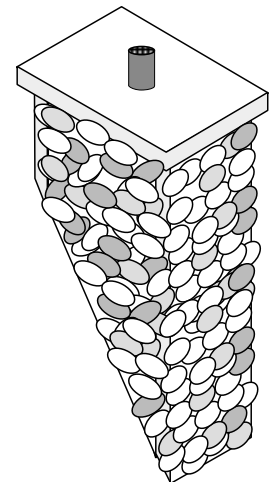
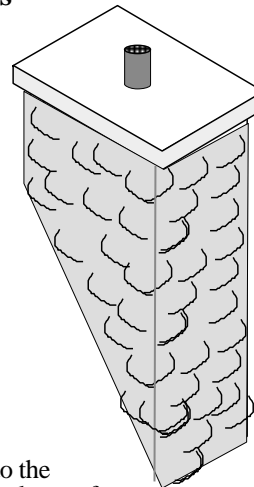

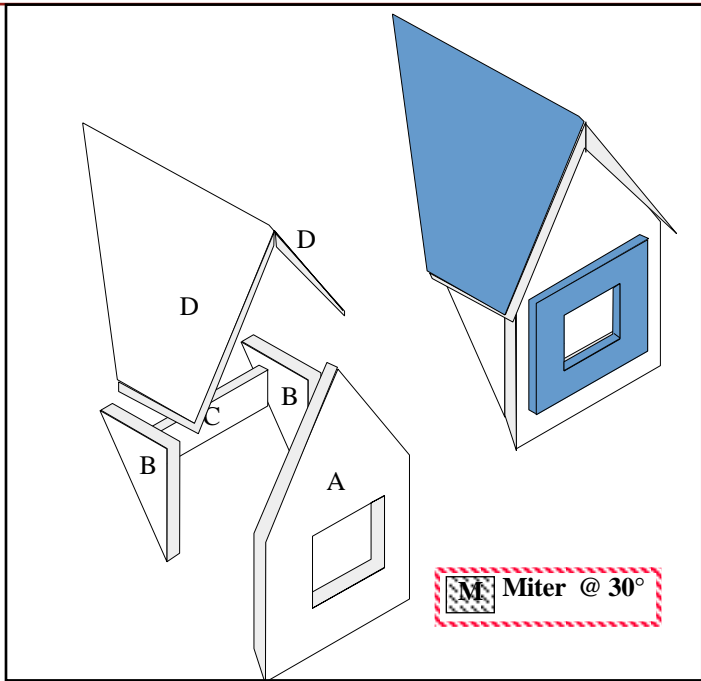

**Patterns - Cut from 1/4" Plywood**

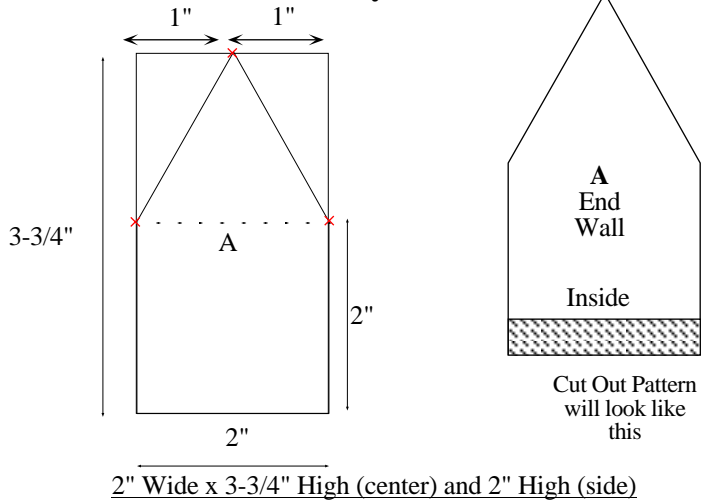

- Begin with a rectangle 3-3/4" High x 2" Wide
- Measure and mark the top center (1" from each side)
- Measure and mark 2" up from the bottom on both sides
- With ruler, draw your lines between the x's, forming the roof line.
- Cut out 1 End Wall
- Cut out window opening prior to assembly (See Dormer Window)

**C**  
Brace

1/2" x 1-1/2"  
Cut 1

**B - Dormer Sides**

- Begin with a rectangle 1-9/16" High x 29/32" Wide
- With ruler, draw an angle from the top Left Hand Corner to the bottom Right Hand Corner.
- Cut out 2 Side Walls  
*The 2 halves will make 2 side walls*

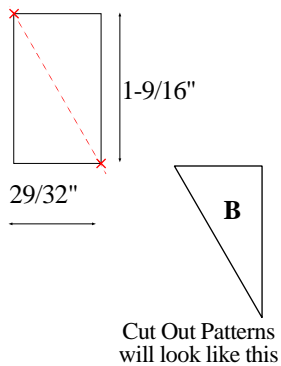

**D - Roof for Dormer**

Cut 1 Each Side

3" High x 3-5/32" Wide (Angles will be cut as indicated.)

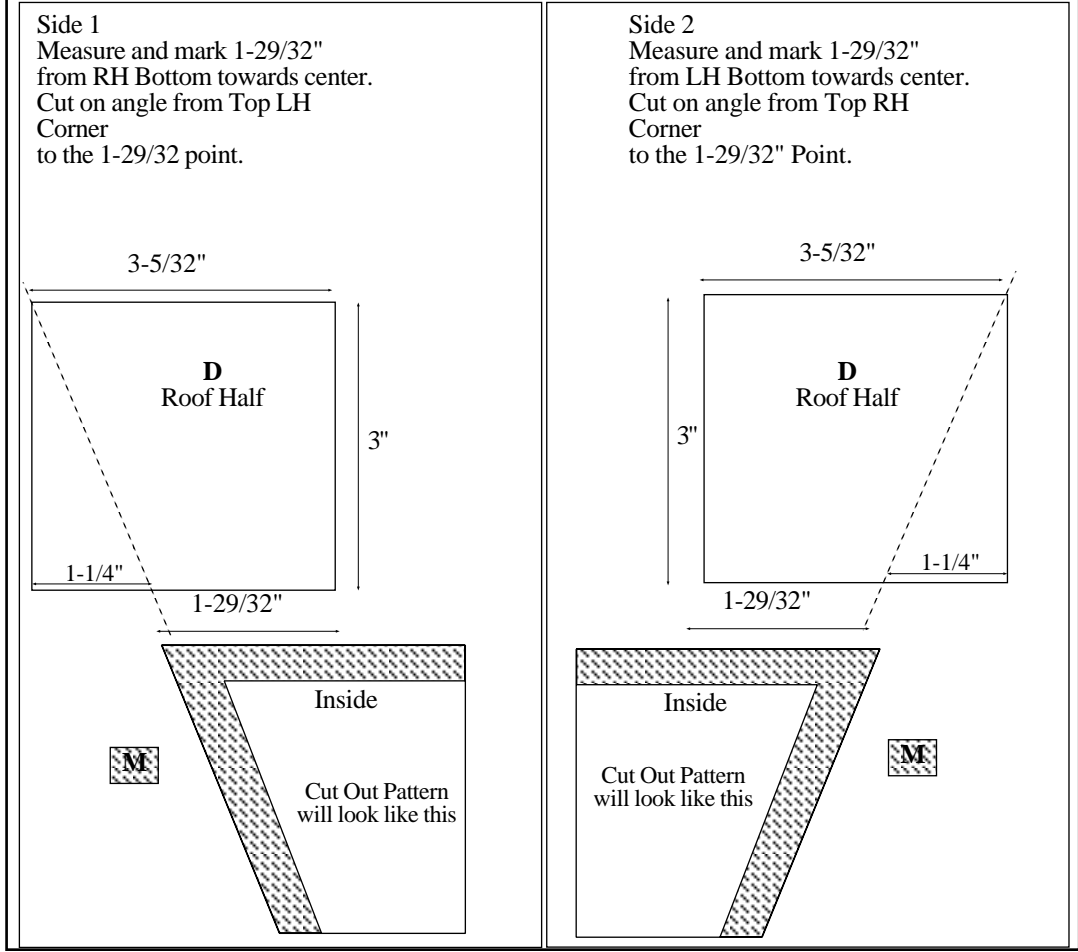

**Assembly**

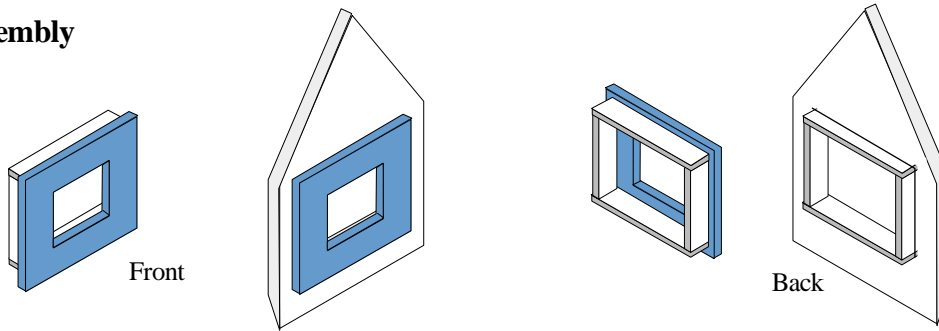

1. Window opening will have to be cut prior to assembly. It will probably be easier if you also go ahead and install the window, as it should be in place prior to adding the roof.

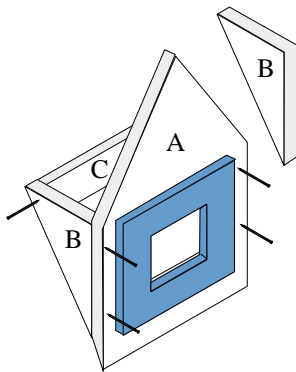

2. Note part A (End) is assembled on the outside of part B (Sides). Part C (Brace) fits inside the sides. Lightly Glue and nail or staple the sides, end and brace together as illustrated.

**See Page 38**  
**Dormers are added after the roof is installed on the house**

3. Attach the dormer to the roof of the house, again using a light bead of glue and nails or staples. Run a bead of glue along the top exposed wood of the dormer, where the roof will fit.

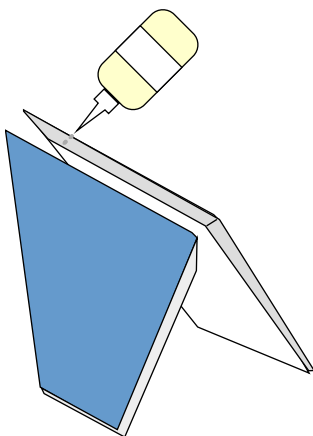
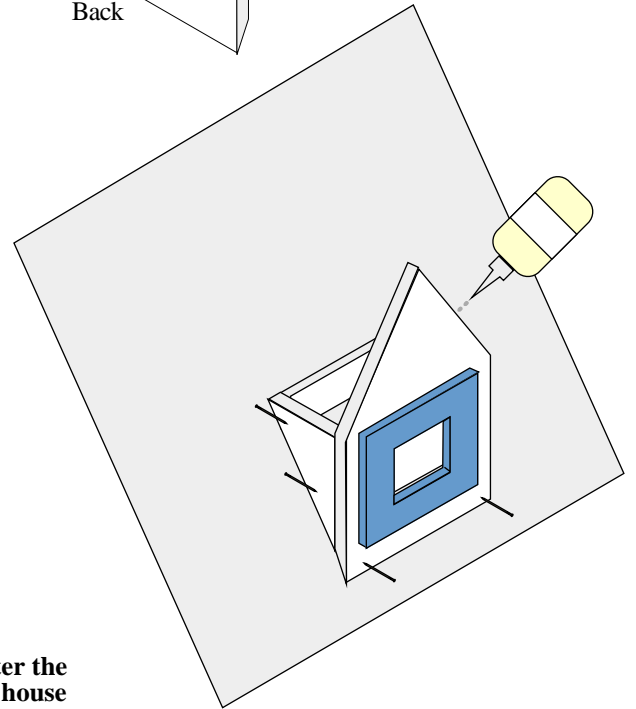

4. Run a bead of Wood Glue along the top inside mitered sides of the dormer roof

5. Center the dormer roof on to the dormer and securely attach with glue and nails.

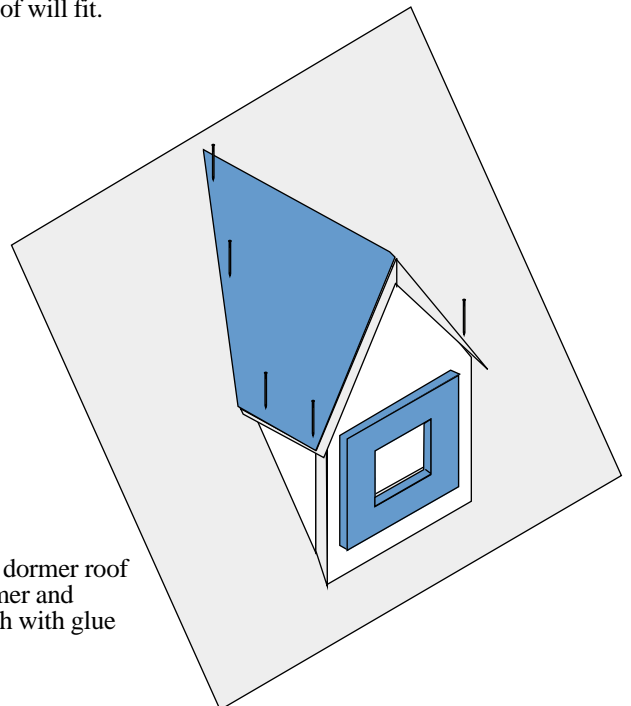

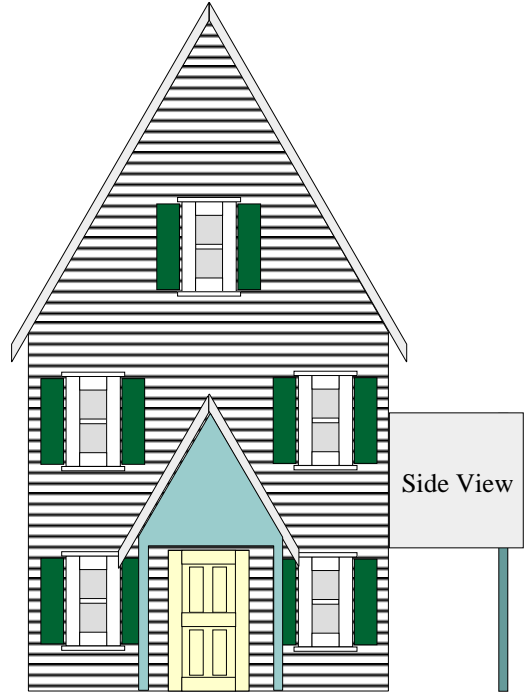
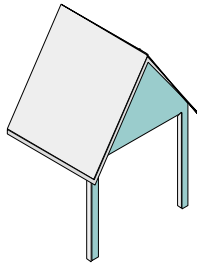

Patterns

Cut from 1/4" Plywood

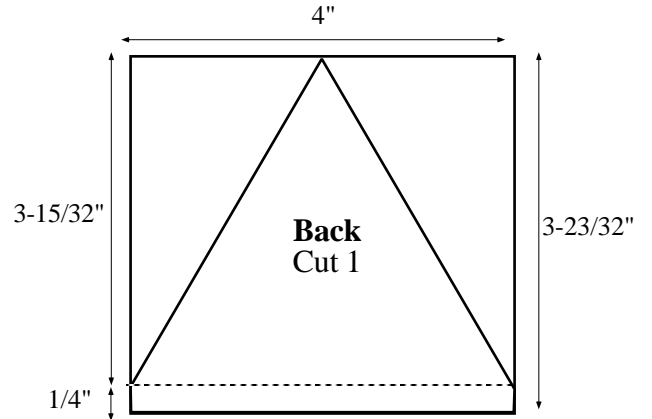
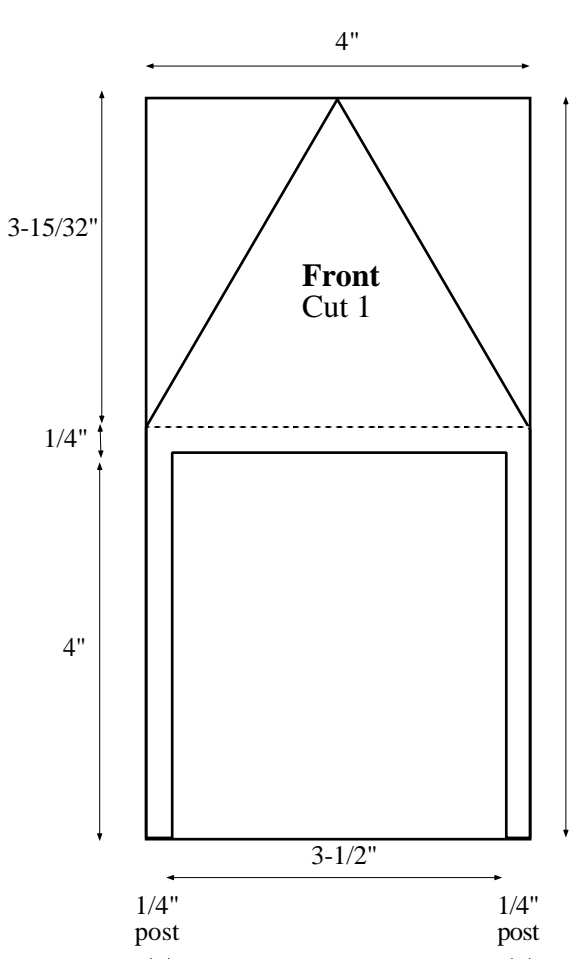

7-23/32"

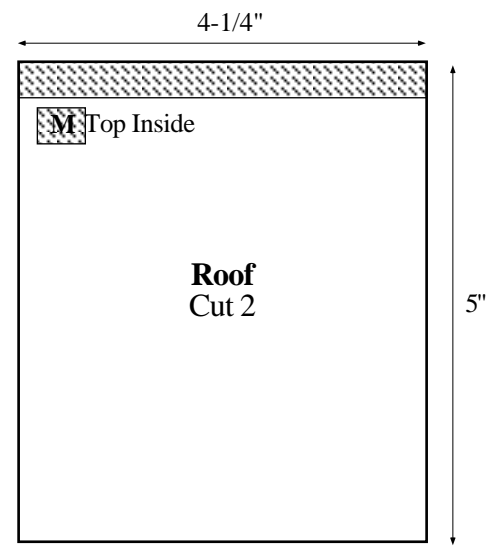
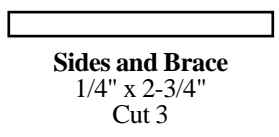

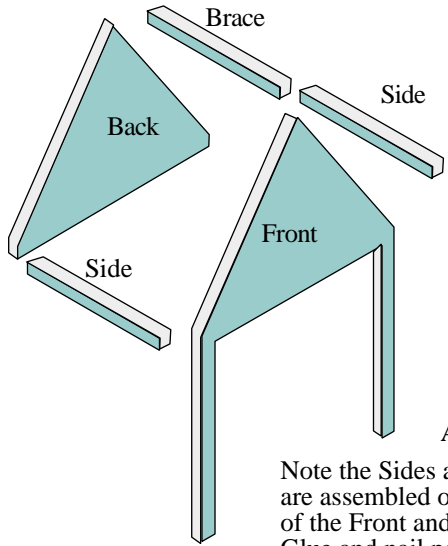

A.

Note the Sides and Brace are assembled on the inside of the Front and Back. Glue and nail porch as shown.

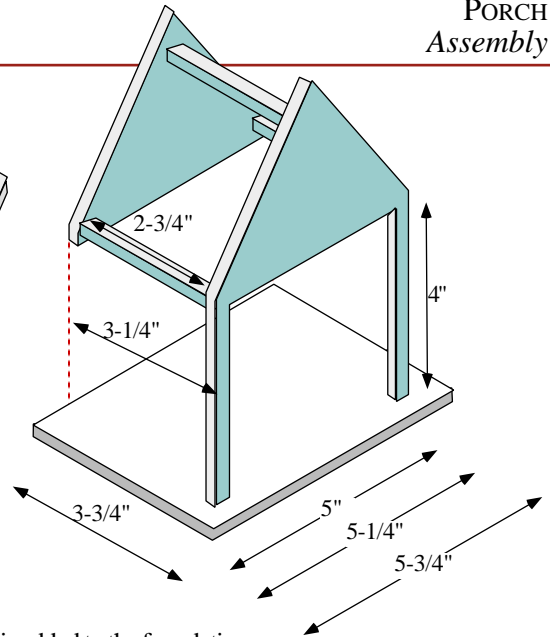
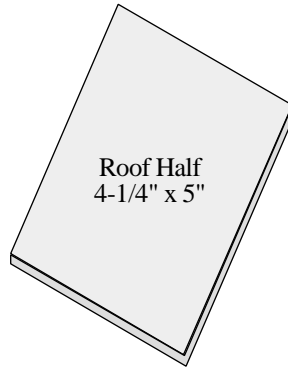

Base is added to the foundation  
Length According to Placement on wall

Any wall porch centered 3-1/4" x 5"  
End Wall - porch to the side 3-1/4" x 5-1/4"  
Side Wall - porch to the side 3-1/4" x 5-3/4"

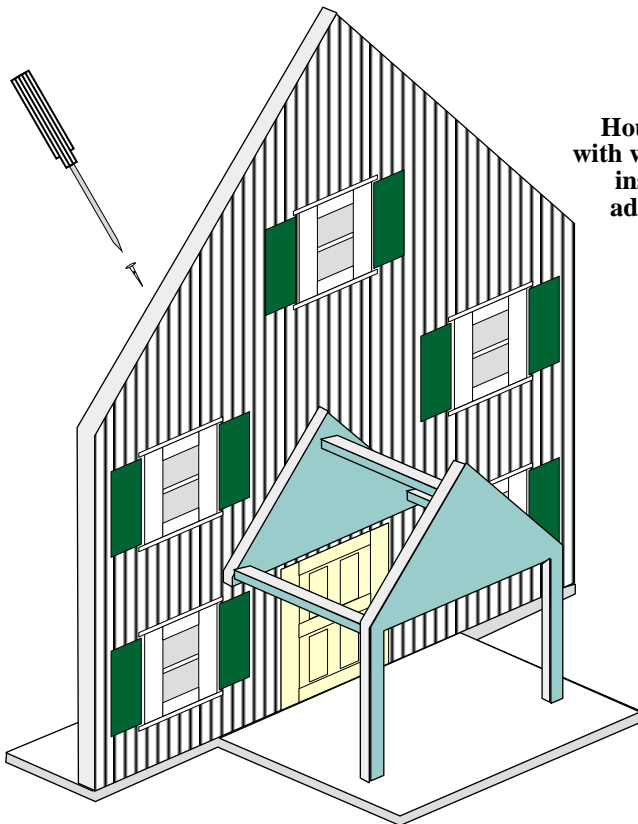

B.

Glue and screw from the back of the wall through the two pilot holes into the porch back to secure the porch frame to the house.

House is assembled with windows and doors installed prior to adding the porch. See page 36

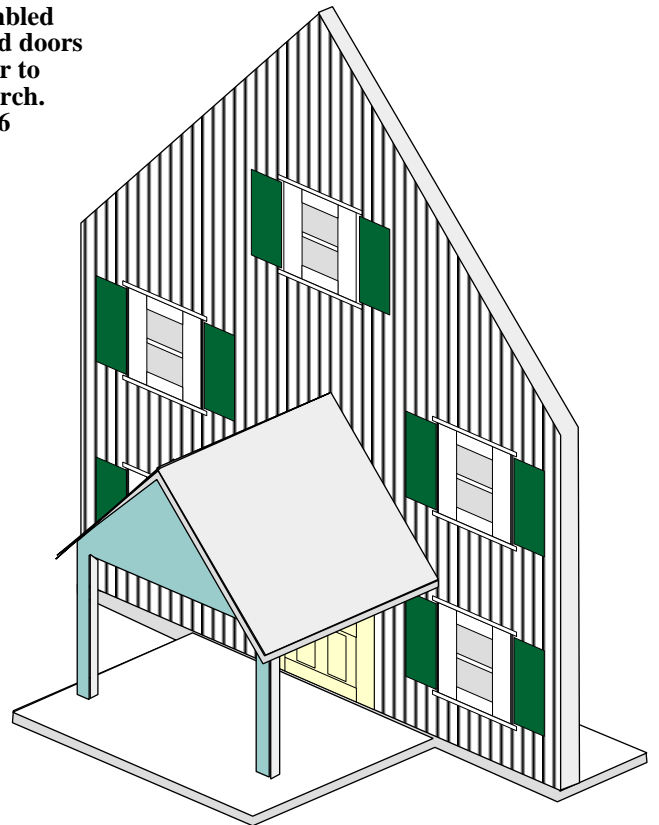

C.

Carefully center, glue and nail roof onto porch as shown.

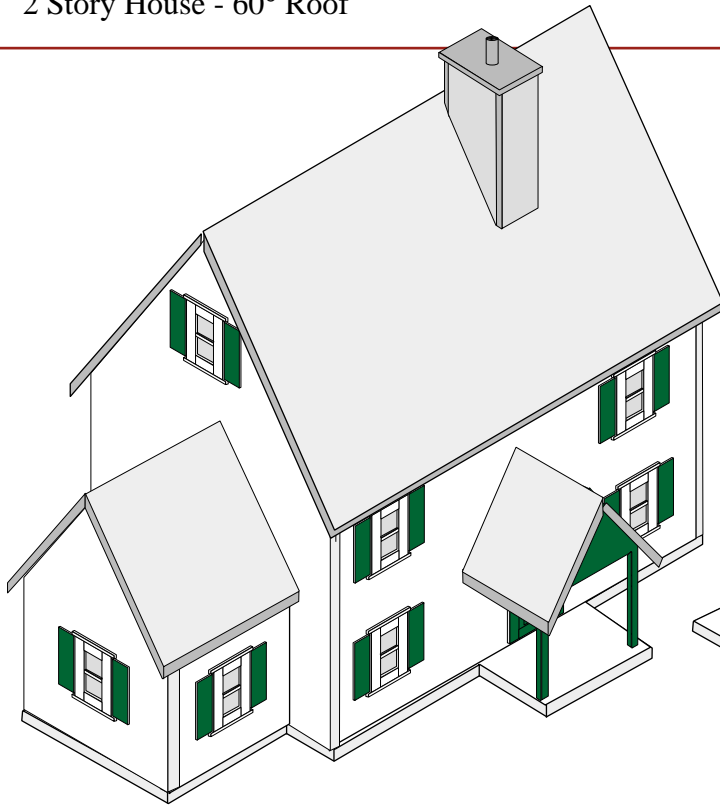

The following illustrations will show assembly of the house.

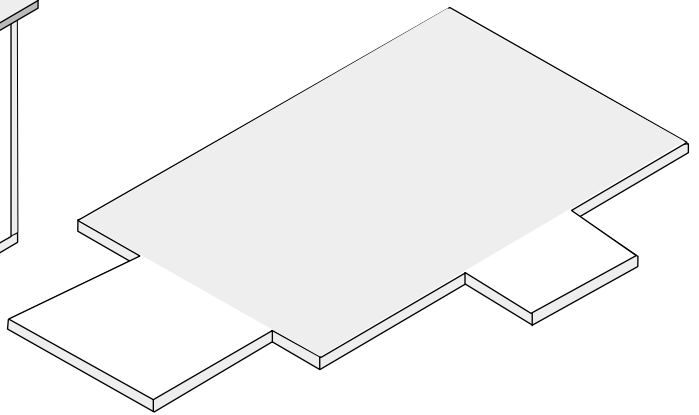

**1.** The Foundation

Using your Basic Foundation plans and any additions you have decided upon, cut out the Total House Foundation. (For illustration only, the Basic Foundation area is shaded.)

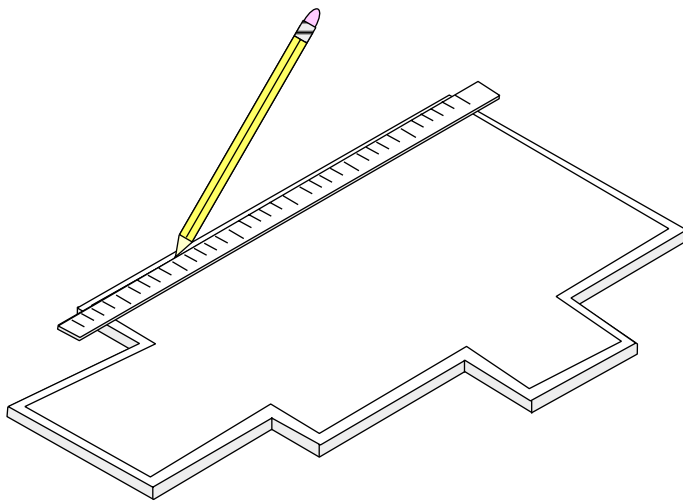

**2.**

Using ruler and pencil, measure 1/4" inside the foundation for frame placement. (Walls are 1/4" thick)

**Frame Layout Diagram  
(Top and Bottom)**  
Use diagram for steps 3 and 4

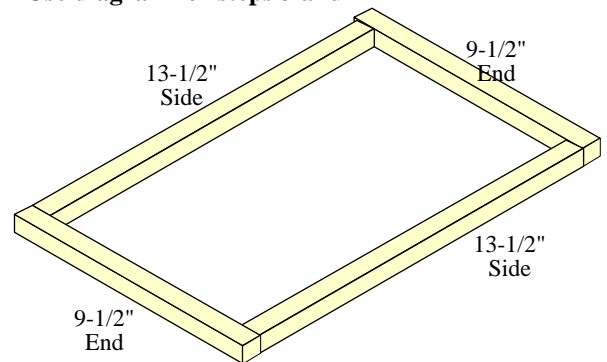

Note:

Ends are assembled outside of the sides to make a required rectangle of  $9\text{-}1/2" \times 15"$  (Furring strips are nominally  $3/4"$  square) If different sized furring strips are used, adjust the side measurements to maintain the required overall size.

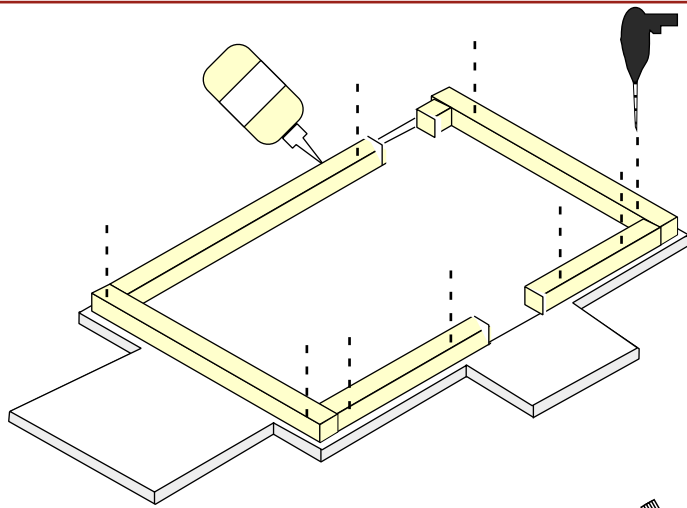

3.

### Bottom Frame

- Using the Frame Layout Diagram on Page 31, lay the frame strips out on the foundation inside the 1/4" boundary.
- If you are using opening doors, cut out appropriate spaces wherever you wish to place the doors. For non-opening doors, do not cut the frame.
- Holding the frame strips in place, drill pilot holes through the frame and the foundation. Be sure and check that squareness is maintained.
- One at a time**, glue the bottom house frame strips onto the foundation. Immediately go to step 3A, beginning with the first strip.

### 3A. To firmly anchor the house frame:

- Turn the foundation onto it's back.
- Using the pilot holes as guides, screw the frame strips in place (one at a time).
- When all frame strips are secured with screws, turn foundation right side up and check once more for squareness at corners. Adjust if necessary.

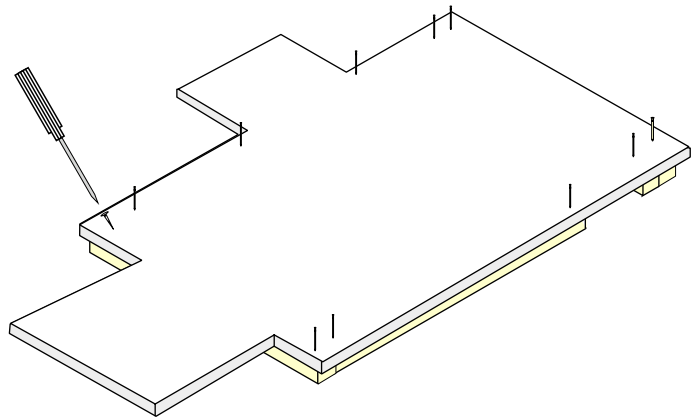

### 4. Top Frame

Again, use Frame Layout Diagram, page 31

- Lay the strips out on a flat surface, using uncut strips. (No openings for doors.) The overall dimensions will be the same as the bottom frame.
- Glue and Nail or staple the bottom frame together, again maintaining corner angles.

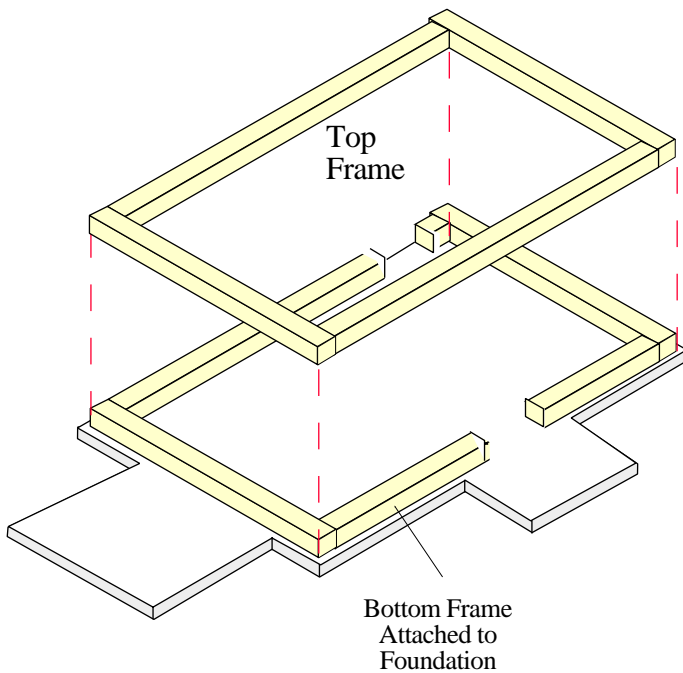
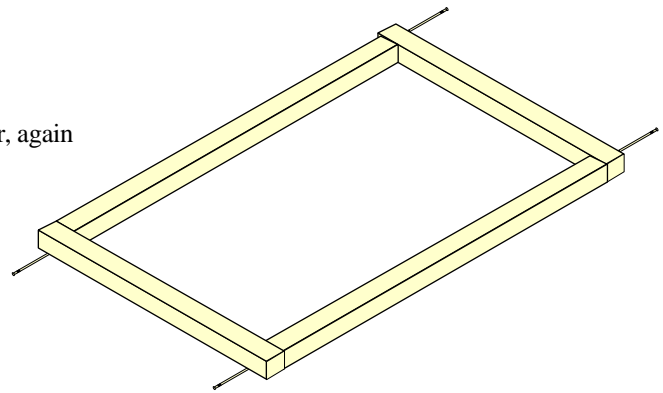

### Check Alignment of Horizontal Frames

5.

- Position the Top Frame over the Bottom Frame to ensure that the two pieces are in alignment.
- The two frames should line up vertically and be the same dimensions on all sides. If they don't line up, double check your work and make adjustments. (Favorite thing to do)
- Then lay the Top Frame aside.



6. Vertical Studs  
Each wall needs a vertical stud on each end.  
Lightly glue and nail or staple a vertical stud  
at each corner for the walls to be attached to.

Note: Nailing the studs in place will be much easier if you  
begin with drilling a small pilot hole for the nail.

Note:  
The Horizontal Brace will be 8" long  
if all furring strips are 3/4" square.

If your strips are a different size,  
measure between the two vertical  
studs at the end for the length of brace  
needed .

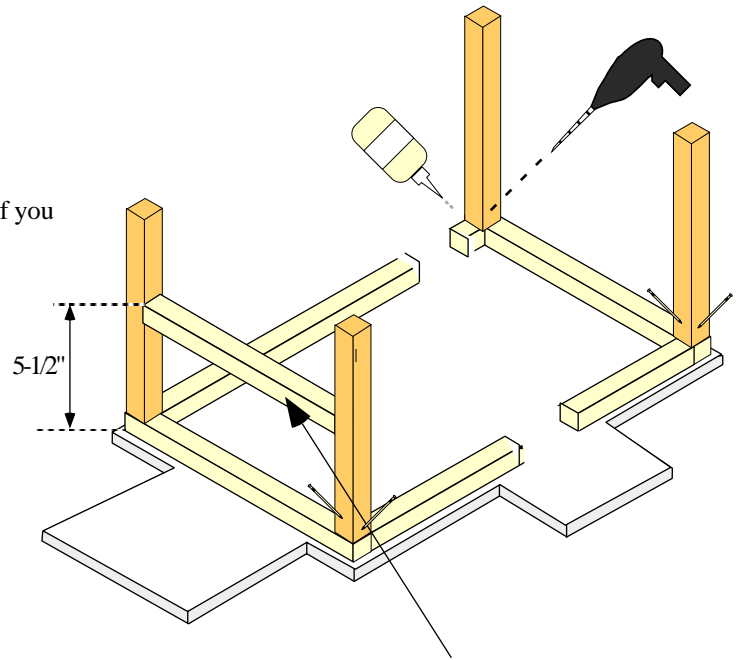

If you are adding a room addition, you can add  
an additional horizontal brace to your frame.  
Install the brace top at 5-1/2" above floor level.

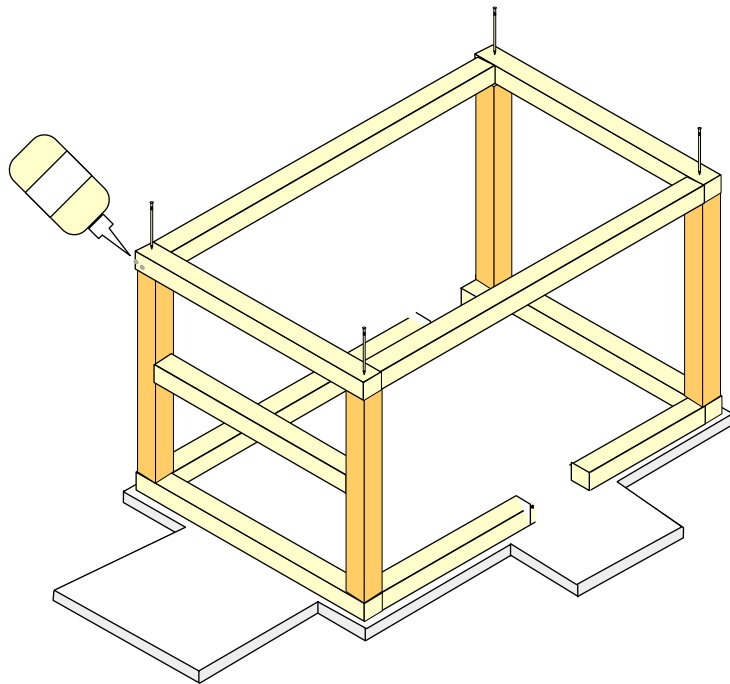

## 7.

Lightly glue the tops of the vertical studs  
Place the assembled top brace on top of  
the vertical studs, matching up with  
the bottom brace.  
Nail or staple the top brace to all vertical studs.

# 8.

## The Walls

- Cut out all building walls, including openings for doors and windows. (See page 21)

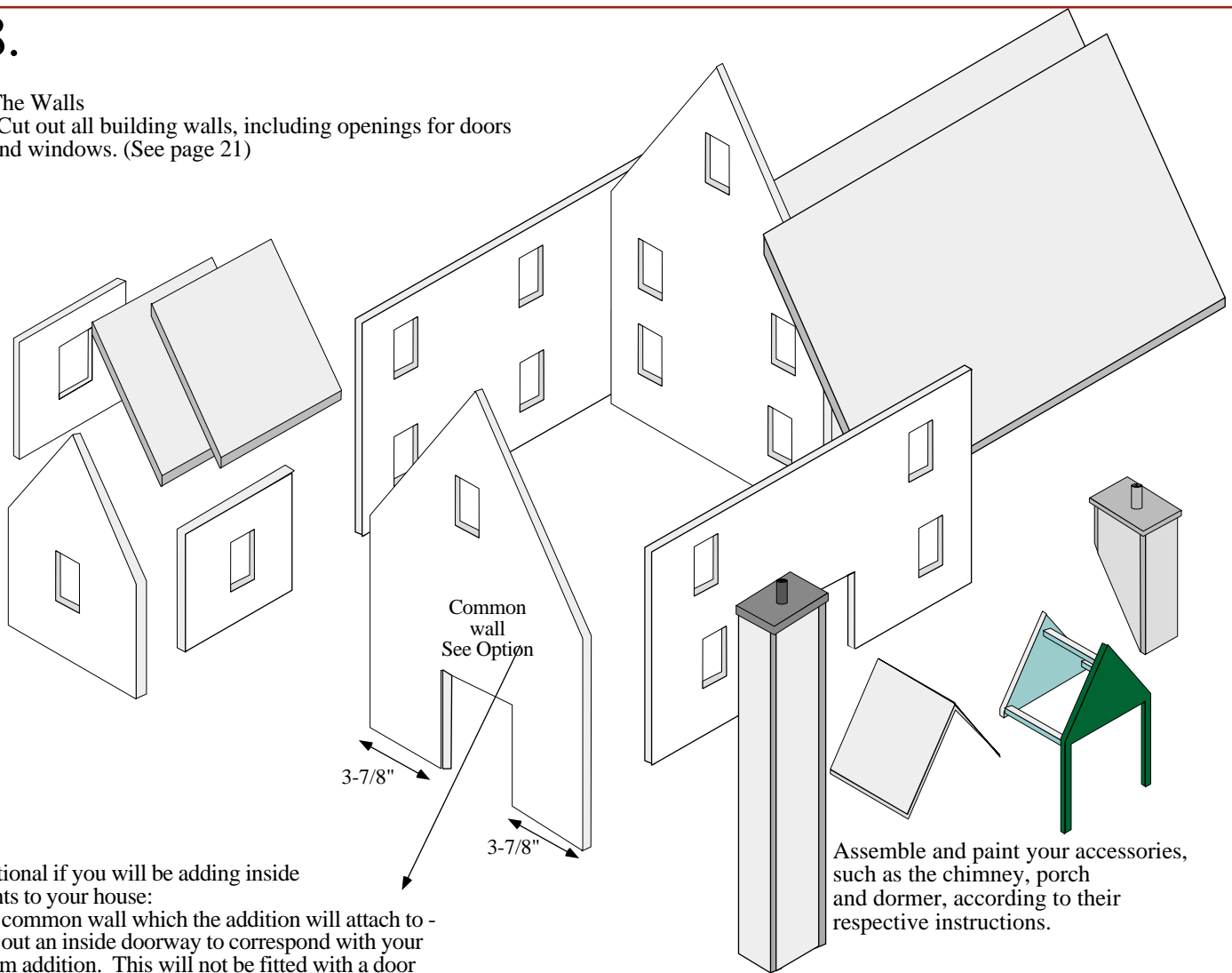

Optional if you will be adding inside lights to your house:  
On common wall which the addition will attach to - cut out an inside doorway to correspond with your room addition. This will not be fitted with a door but will allow the light to flow through the entire house. You won't have to cut into the frame for this door. Center the doorway and cut the opening 2-1/4" wide x 4" high.

Assemble and paint your accessories, such as the chimney, porch and dormer, according to their respective instructions.

9. Install the common wall  
Center the wall.  
Glue and nail or staple the wall firmly to the frame.

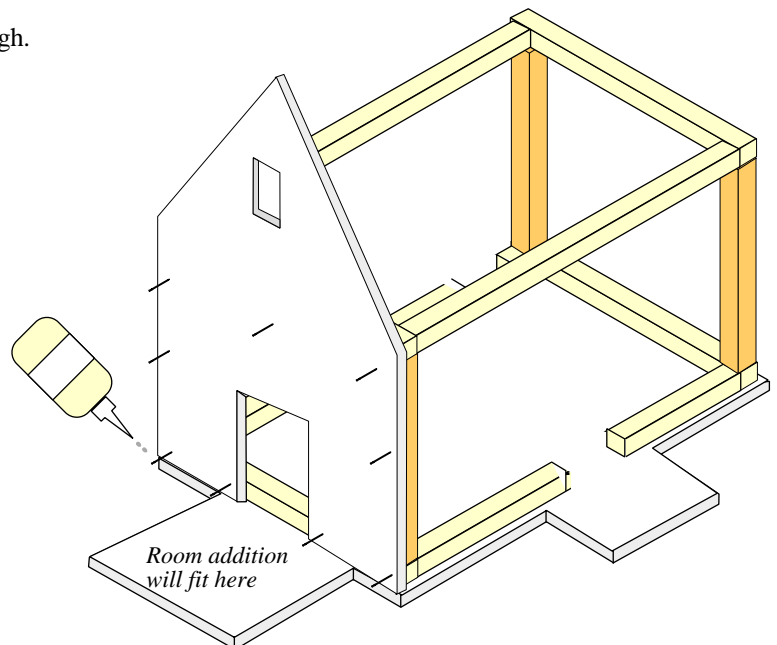

10. Using the same rules as you used for the house frame, build up the room addition frame. (Attach the bottom parts to the foundation. Then the vertical braces and top frame.)  
Glue and nail the frame top through the common wall and center house brace.

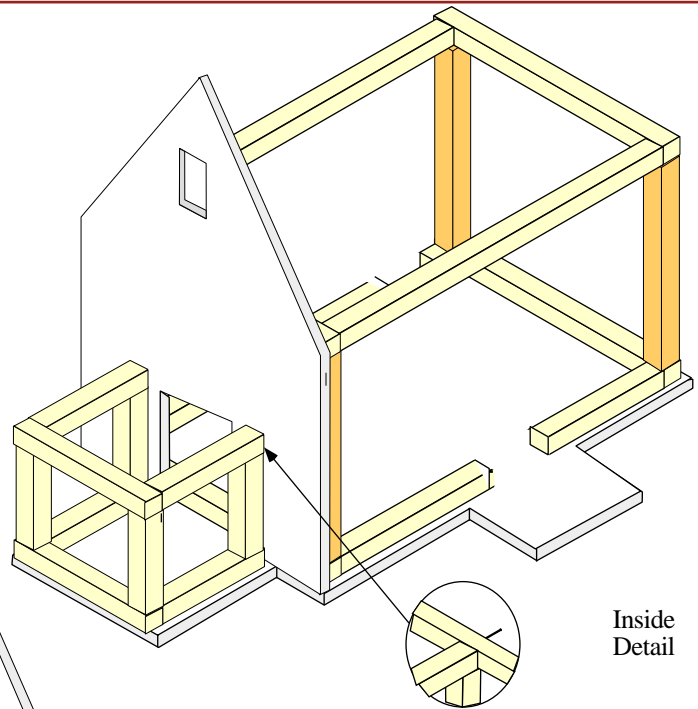

11. Start at one side of building and nail or staple walls in place to the frame. Work walls together in a clockwise or counterclockwise direction. Direction doesn't matter. Just fit the adjacent walls and keep going in the same direction.

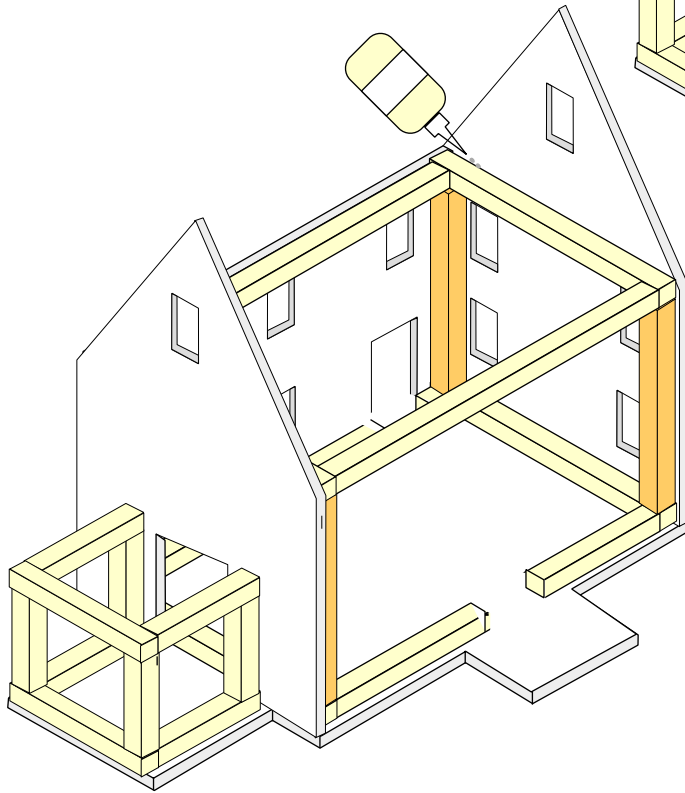

12. Continue adding walls until all walls are in place. Always nail or staple into the frame. Check that each wall is sturdily attached and that there are no "floppy" walls.

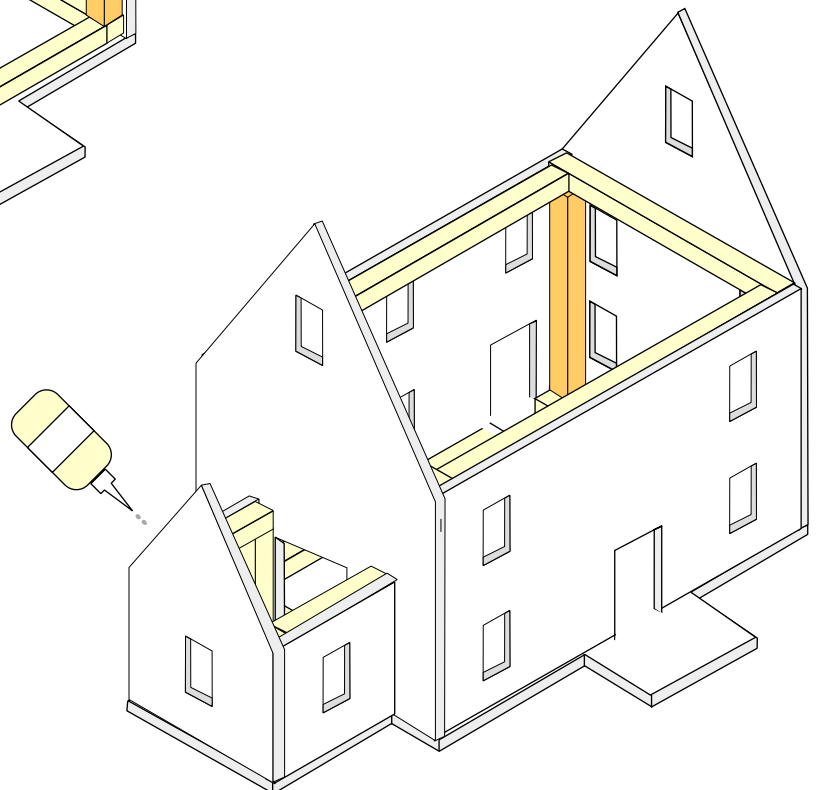

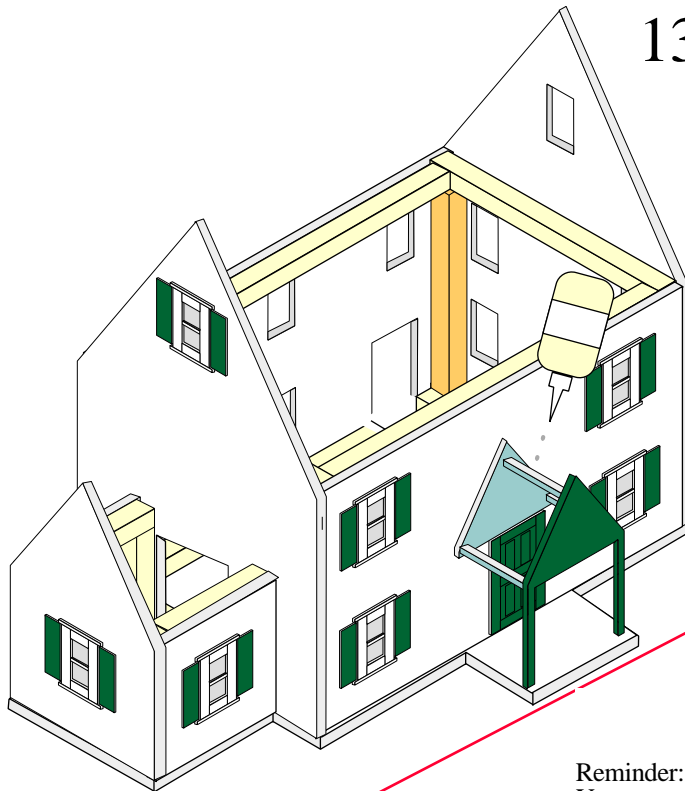

13.

- Paint and seal your house and allow to dry.
- Install Doors and Windows, per instructions on page 22

•Glue and screw from the back of the wall through the two pilot holes into the porch back to secure the porch frame to the house.

Be sure to secure the posts to the foundation. When dry, carefully center and attach the porch roof.

## 14. Rooftop Chimney

Reminder: Don't place the chimney directly above a door or window opening. You can attach the assembled chimney to the roof before or after you attach the roof to the house.

Run a bead of glue on the bottom side of the chimney frame and attach with small nails or staples.

You may want to caulk around the outside bottom of the chimney to ensure a good seal.

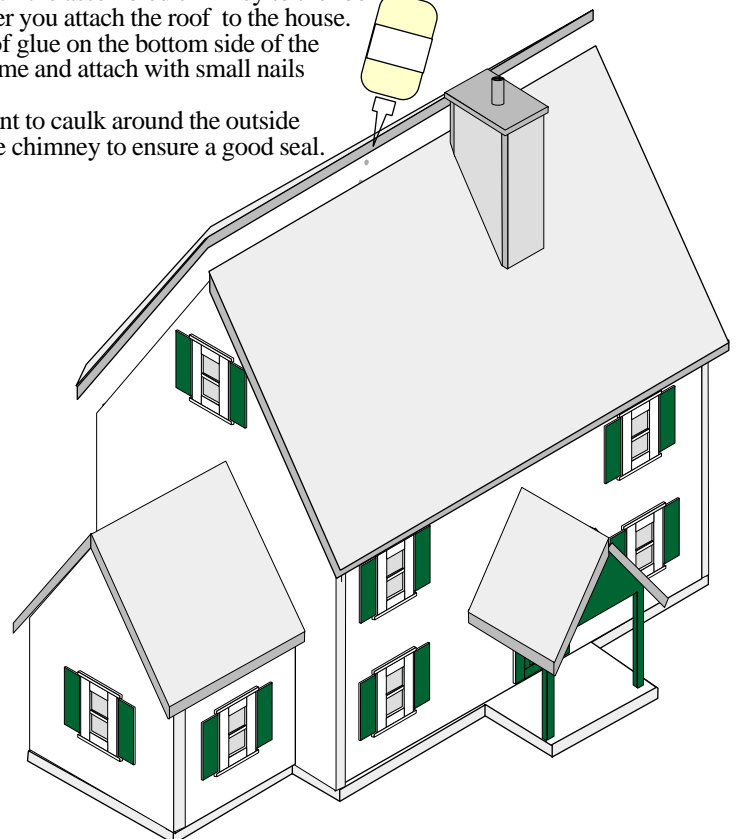
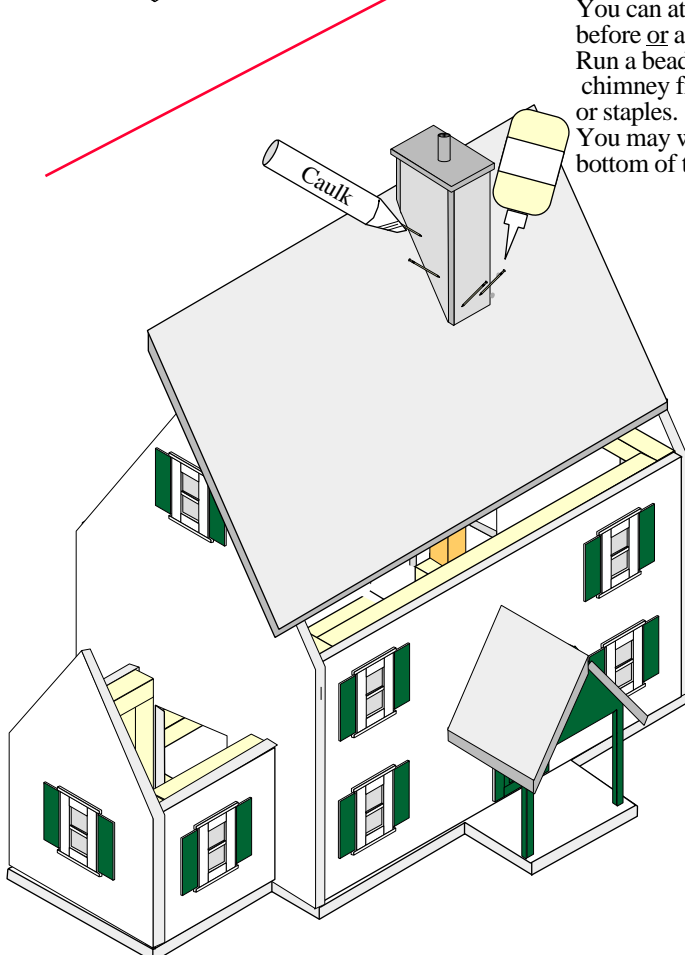

15.

Attach the Roof to the House

•Run a bead of glue around the exposed wood that the roof will sit on.

•One at a time, carefully center one roof half in place. Glue and nail or staple to the building, nailing into the frame. Match up the second half and secure in the same manner, making certain that the roof tops are lined up.

**Note: If you are adding lights to your house, use screws to attach the roof. This will enable you to have access to the wiring.**

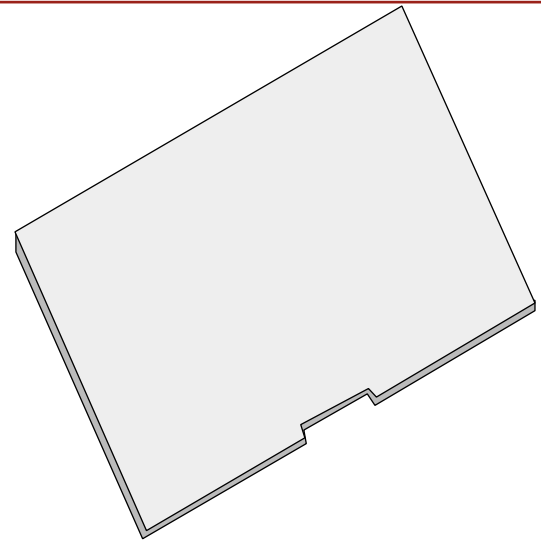
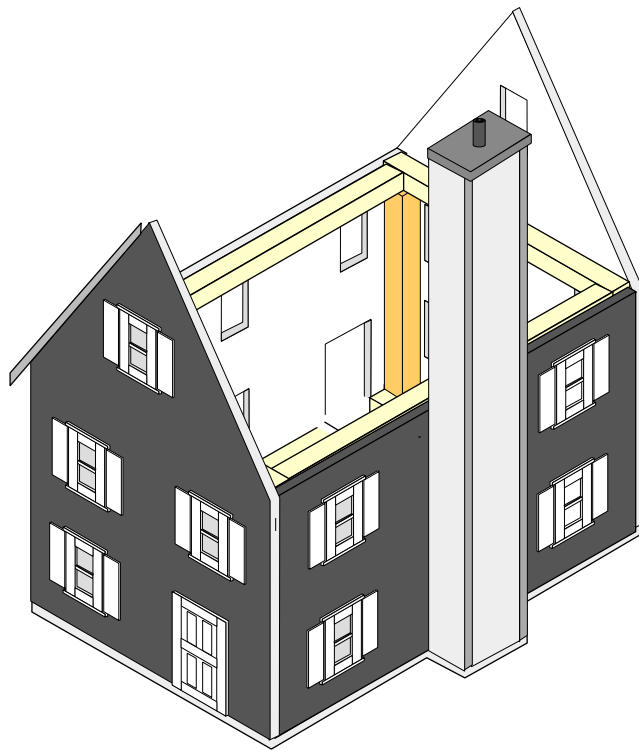

## 14-A. Optional Ground Chimney (page 26)

Glue the assembled ground chimney to the chimney foundation and the side of the house. Secure with nails or staples from the inside of the wall.

**Note: If you are adding lights to your house, use screws to attach the roof. This will enable you to have access to the wiring.**

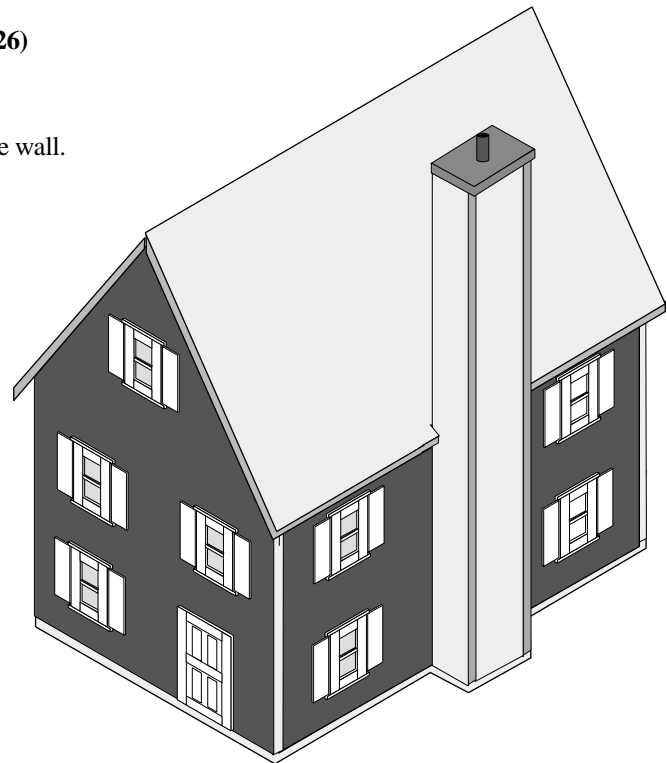

## 15-A. Attach the Roof to the House

- Run a bead of glue around the exposed wood that the roof will sit on. Fit the chimney side half of the roof around the chimney. You may have to trim the cut-out a bit for a good fit.
- One at a time, carefully center one roof half in place. Glue and nail or staple to the building, nailing into the frame. Match up the second half and secure in the same manner, making certain that the roof tops are lined up.

## 16.

### Addition Roof

Carefully place the one half of the addition roof onto the addition .  
Secure with glue. Place the other half of the roof.  
Line up the roof lines at the top and overhangs.  
Make sure there are no gaps between the two  
roofs. You may have to do a minimal amount of  
trimming at the overhang to get a smooth finish.  
Nail or staple the roof halves in place.

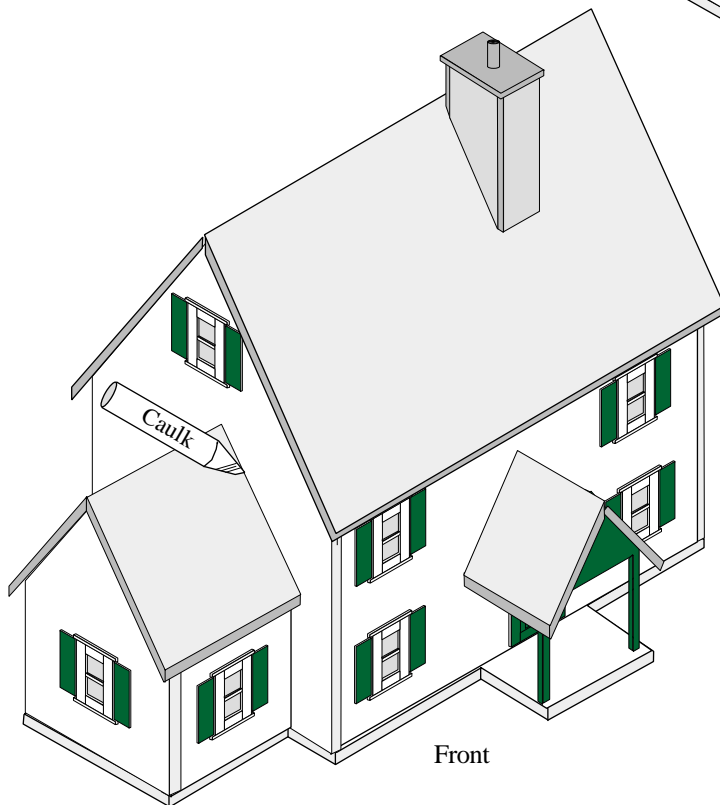
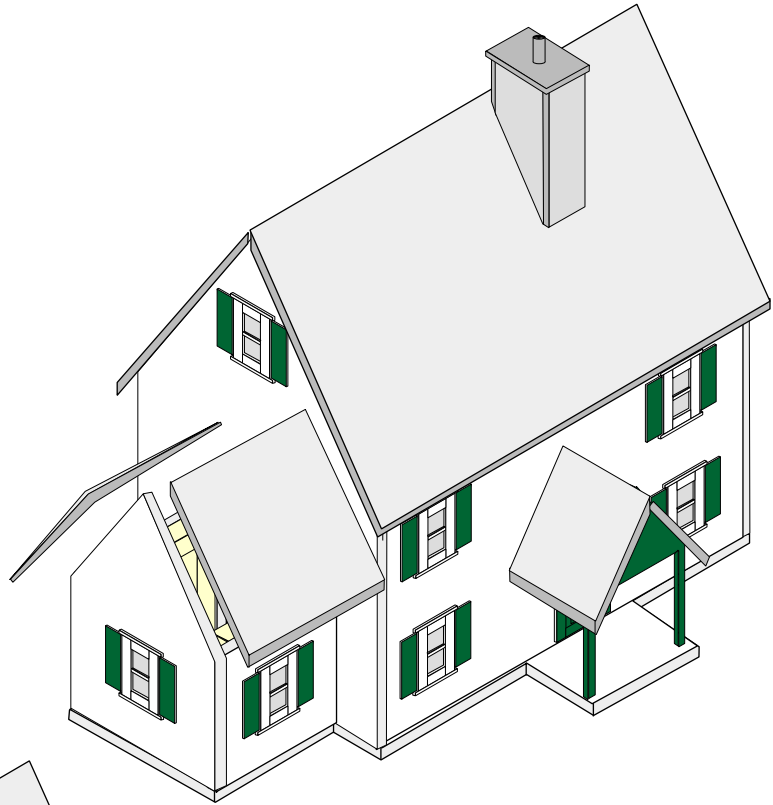

Front

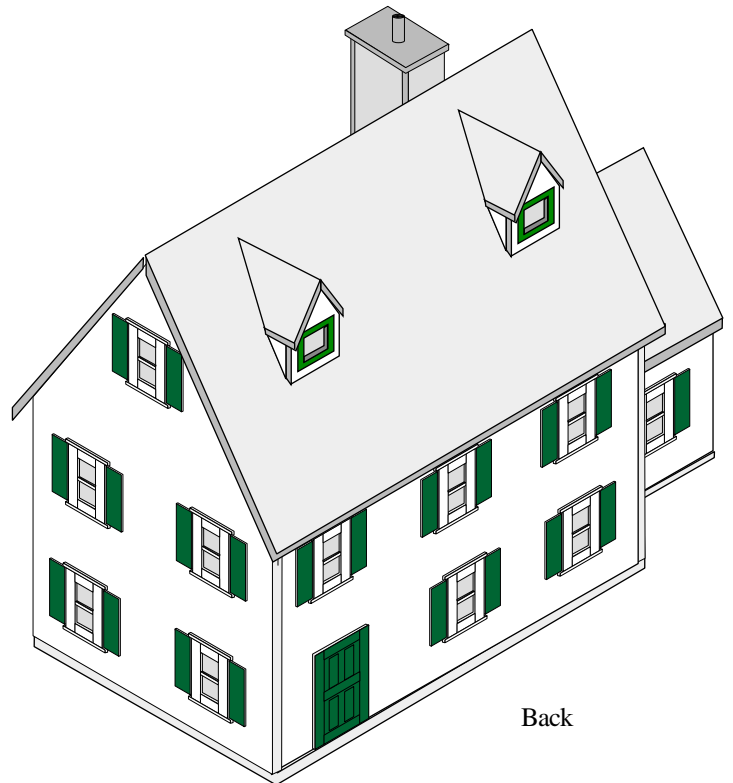

Back

## 17.

If there is a small gap just run some caulking down the "seams".  
Then if you paint the roof, paint over the caulking when dry.  
If you add wooden or other type shingles, the shingles will cover the  
caulking.

**Optional Dormers:**  
Using ruler and pencil, measure and lightly  
mark where you will place the dormers.  
Add the dormers, as per instructions with  
dormer assembly (page 28).