

- Build your houses from 1/4" plywood to your own design
- Decorate with commercial trims or make your own trims
- Add commercial windows and doors on the 1:24 scale or build your own from 1/8" wood. Garden Towns Doors and Windows patterns sold separately.
- Optional: Add lights, using manufacturer's instructions

Scaled and easy to read patterns and instructions for wood houses. Yard and Garden Buildings Compatible with Garden Railroads or a delight for any child's collection

House Patterns:
 Walls, roof, and foundation
Accessories Patterns:
 Room Addition
 Porch
 Chimney
 Dormer

Overall Dimensions

Basic House Foundation*: 10" x 15-1/2"
 Walls: 1 Story - 5-1/2" high with 10" roof peak
 2 Story - 10" high with 15" roof peak

*Room addition, porch or chimney will add to foundation



1
 Basic House
 (no additions)

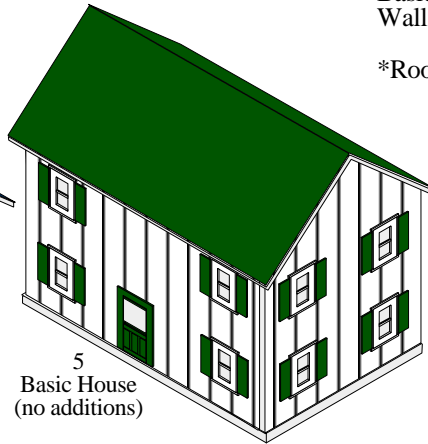

5
 Basic House
 (no additions)



6
 With room addition on side
 centered porch and centered ground chimney

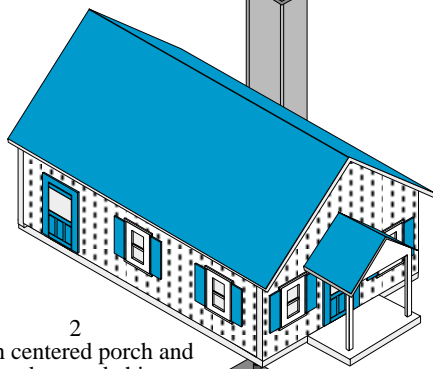

2
 With centered porch and
 centered ground chimney

**There are nine houses illustrated
 with specific walls.
 Walls shown are not inclusive.
 You can mix and match the wall
 arrangements to design your
 own house.**

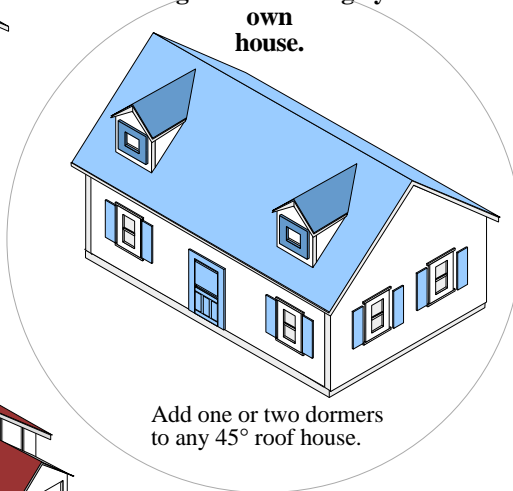

Add one or two dormers
 to any 45° roof house.

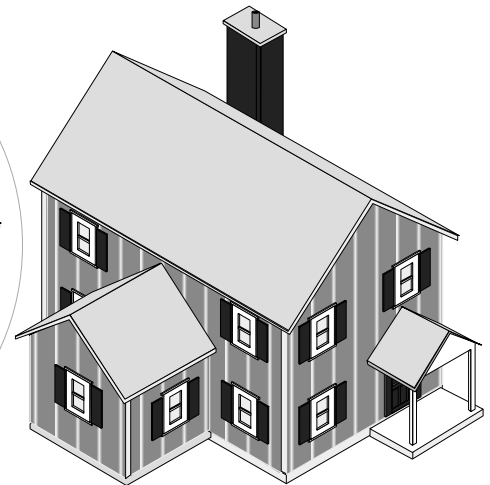

7
 With room addition on side, porch to
 side
 and ground chimney to side

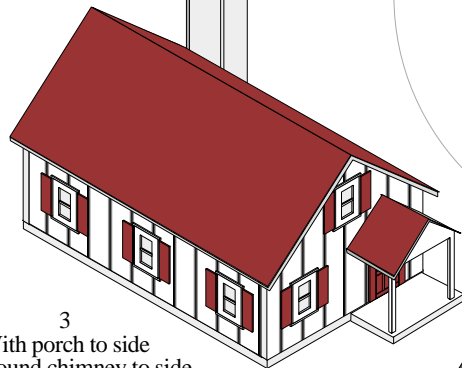

3
 With porch to side
 and ground chimney to side

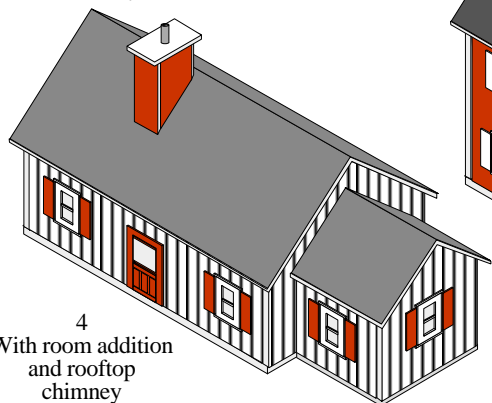

4
 With room addition
 and rooftop
 chimney



9
 With room addition on end,
 rooftop chimney and porch to side

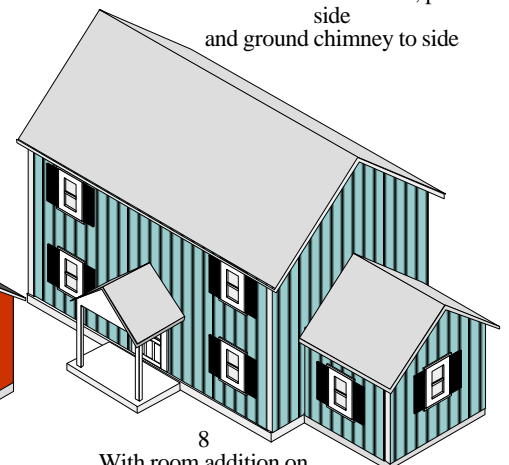

8
 With room addition on
 end
 and centered porch

Thank you for purchasing the Garden Town pattern. As a background, the Garden Town houses and buildings were inspired by the Garden Scale Railroads. We wanted to build small towns as backdrops for the trains. After building several prototypes, we discovered that they are actually fun to make. They don't even have to have a railroad to accompany. Depending on your choices, each of the houses can be different. They can be an addition to your flower garden. Or a backdrop toy for a child. If you are building yours for outside display, do keep in mind the elements. Houses will have to be sealed with polyurethane or varnish to minimize weather damage.

Please take a few minutes and go over the Steps to Building Your House before you begin.

We hope you enjoy your project!

Table of Contents

Before You Begin	
Steps to Building Your House	3
Tools and Supplies	
General	4
Door and Window Requirements	5
Working With Small Items	6
Layout - Accessories Only	7
Layout - Houses with Accessories	8
The Frame	9
Hints and Tips	
Two Ways to Assemble Roof	10
Mitering	11
Planning the House	
1 Story Plans to choose from	12
2 Story Plans to choose from	14
Planning the Walls	
Addition walls and 1 Story Side Walls	17
1 Story End Walls	18
2 Story Side Walls	19
2 Story End Walls	21
Accessories - Patterns and Assembly	
Chimney	22
Dormer	26
Porch	28
Patterns	
1 Story House Walls	30
2 Story House Walls	31
Roofs for 1 or 2 Story	32
Room Addition - all 45° Roof Houses	33
Foundations	34
Assembly	
Walls	37
Building	39

Planning the House - 1 or 2 Story Plans to choose from - Decide which house you will build. If you use one of the houses we have illustrated, we have indicated which floor plan patterns and wall fittings to use.

Planning the Walls section is to be used as a guide for placement of doors, windows, chimney and room addition.

Accessories:

A Room Addition or Porch will fit on the End Wall of a 1 or 2 Story House. They will fit on 2 Story Side Walls only. (The roof line is too low on a one story house).

Roof Chimney will fit on any house. Don't place the chimney directly over a door or window. Towards the peak of the roof is the desired area.

Ground Chimney can be used on 1 story or 2 story house.

The 2 story chimney is taller. Dimensions are given for the patterns. Be sure and use the appropriate roof half which has the chimney cut-out. Use Floor Plan 2 or Floor Plan 4 which has a chimney base.

Dormer can be used on any of the roofs.

Doors and Windows

Opening Type Doors - If you use commercially purchased doors, you will have to cut into the house frame. Our illustrations show how to make the opening. The size of the opening will depend upon the doors and windows you purchase and the instructions which come with them.

Non-Opening Doors-Such as Kiva Design Garden Town Doors and Windows, which you build yourself, you can build a simple "box frame" for the house. The window openings will be above the frame and the 1/8" thick doors will fit into the 1/4" walls.

Keep in mind:

A house should have a minimum of 2 exits (doors). Door and window openings will need to be at least 1" from the sides and 1" from the top of the wall so they don't interfere with the building frame behind the walls.

Before You Begin

Tools and Supplies -

"Layout"

Record how much 1/4" Plywood you will need to build the house you want.

"Door and Window Requirements"

Record how many you will need. Decide if you want to purchase or build. Record supplies you will need.

"Frame"

Record how many feet of 1" Furring Strip you will need.

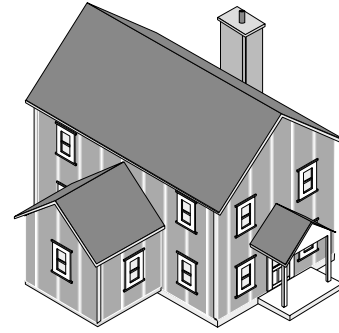

Optional - Items to consider from the hobby store:

Lights - Add Lights according to manufacturers instructions. We suggest that you use screws instead of nails when attaching the roof to allow future access to the wiring and bulb.

You can buy scaled wood shingles for your roof as well as assorted other detailed items. You can make your own signs with help from a stencil or the stick-on letters and numbers available.

Ready to Build

Determine which patterns you will need:

- 1- Foundation
- 2- Side Walls
- 2- End Walls
- 2 - Roof Halves
- Accessories, as desired

- Cut out all wood, according to Pattern dimensions.
- Mitre the pieces, as indicated on the patterns (see **Before You Begin - Hints and Tips - "Mitering"**).
- Cut Furring Strips for frame (see **Before You Begin - Frame**).
- Measure and cut out door and window openings from the walls, as needed (see Assembly - Walls).
- Sand off any rough edges.
- Optional: Paint or stain the walls. Dings can be touched up later. You may prefer to do this step after assembly is completed.
- Assemble the Accessories, as per individual instructions.

- Assemble the building (see Assembly - Building).

If you are placing your house outside, be sure to protect it with a good seal of polyurethane or varnish.

Window and Door Placement

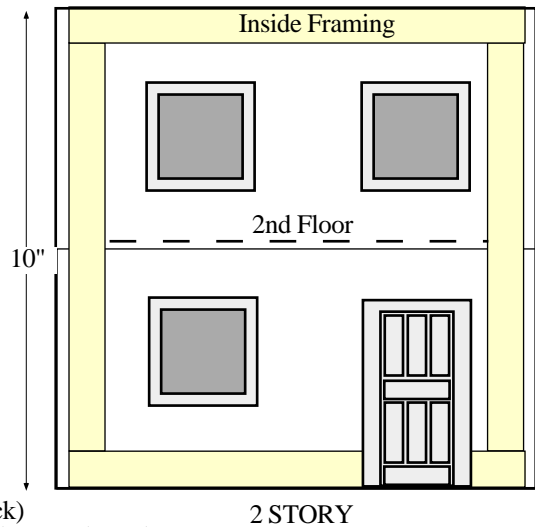
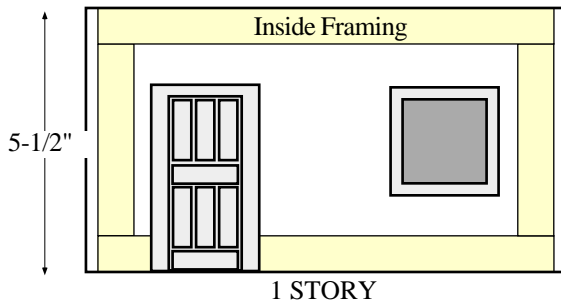

- Buildings and porches are constructed from 1/4" thick plywood
- Framing for the walls is made from 1" Furring strips (nominally 3/4" thick)
- Garden Town Doors and Windows are made from 1/8" thick Balsa wood or Hardwood and plastic glazing for the window panes
- Windows and doors have to be at least 1" from sides and top (to clear inside building frame)
- Doors are placed at floorline
- Floorline on 2nd floor will be 5-1/8" from bottom of wall
- Windows are placed with tops level with doors (some exceptions)

For a few hints to experiment with on the wall finishes, see "Simulated Patterns" in our free **Food for Thought** brochure.

Tools Needed for Building

- Saw (for cutting small wood pieces, a jig saw or coping saw)
- Hammer or Stapler or Air Gun
- Drill (optional for pilot holes)
- Clamps
- T-Square
- Level
- Ruler and Pencil (We prefer see-thru rulers with grids for the small pieces)

Plus If you are making Doors & Windows from Balsa wood

- X-ACTO knife and metal ruler for guide
- Optional:**
- Ruler - the plastic see-thru kind with 1/8" grid is a plus
- Balsa stripper - This little gizmo is used for making various widths of uniform strips from balsa wood. You can set it to cut small widths, (1/8", 1/4", 1/2" etc.)It saves a lot of time if you prefer to cut your own strips.
- Of course you can buy the strips "ready made" at a higher price.
- Clamps (small) - The X-ACTO clamps for small pieces are very handy.

Supplies Needed - General

- 5/8" Staples or Brads
- 1" #6 Wood Screws, flat head
- Small 3/8" - 1/2" wood screws flat head
- 2" Finishing Nails
- Wood Glue
- Paint or Stain - We suggest the water based Acrylic Paints found in a multitude of colors in arts and crafts stores.
- Sealer - Water Base Varnish found with the acrylic paints or a sealer such as polyurethane.
- Optional: Caulking for sealing porches, roofs, etc.

Guide for 1" x 1" x 8' Furring Strips		
1	8'	96"
2	16'	192"
3	24'	288"
4	32'	384"
5	40'	480"

Specific Building Supplies Large 45° Houses		For Details See Page
1/4" Plywood		
1 Story	48" x 42"	8
2 Story	48" x 47"	8
(No. of Sheets)	(1) 4' x 4' any house	
1" x 1" Furring Strips (nominally 3/4" x 3/4")		
1 Story	152"	9
2 Story	184"	
Purchased Doors & Windows or 1/8" Balsa or Hardwood (4" x 36" Boards)		5
Doors & Windows		
1 Story	2	
2 Story	3	
Clear Plastic Glazing for Windows		5
8" x 10" Sheet	1	
Optional Small Parts Frame - Page 6		
1/4" Plywood - 12-3/4" x 12-3/4"		
1" x 1" Furring Strips - Add 52"		

Doors and Windows

Option: You can purchase ready-made doors and windows which actually open. For example, Grandt Line carries a well made and ready to paint plastic selection for Scale 1:24.

or

you can make your own (Garden Towns Doors and Windows Patterns by Kiva Design) These doors and windows are also 1/24 scale, but are a little larger overall for ease in building. They are non-opening (no hinges).

The following are samples represented for the scaled dimensions.

Buildings are illustrated with the Kiva Design Samples. Neither of the samples are inclusive all all doors and windows available.

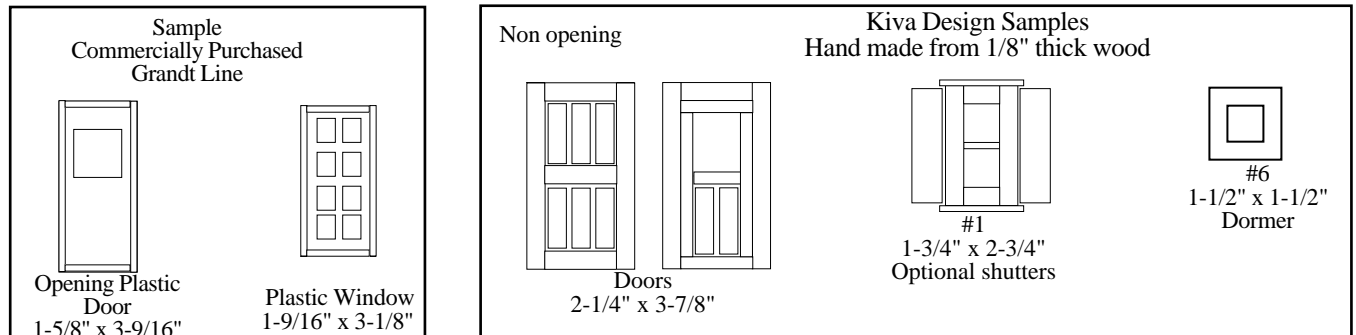

•Purchased Doors and Windows as required

OR

•1/8" Balsa wood or Hardwood for Doors and Windows:
 4" x 36"

(common size at hobby shops)

House	Doors	Kiva Design # 1 Windows	1/8" thick Balsa Wood or Hardwood Number of 4" x 36" boards needed for houses shown*
1 1 Story	2	10	2
2 "	2	9	2
3 "	2	9	2
4 "	2	8	2
5 2 Story	2	17	3
6 "	2	16	3
7 "	2	15	3
8 "	2	14	3
9 "	2	15	3

Use your choice of Garden Towns doors

*Doors and windows shown for the building can be made from the number of boards indicated. However, "we" personally always buy one extra board in the unlikely event that we'll need it to redo our "errors". Left-overs are saved for the next project.

•Clear Plastic for Windows
 8" x 10" Sheet
 (from hobby shop framing area)

Assembly Frame for Small Items

Patterns

Cut from plywood -1/4" thick or any scrap

Cut from 1 x 1 Framing (nominally 3/4" x 3/4")

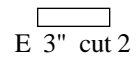
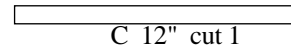
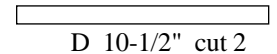
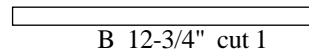
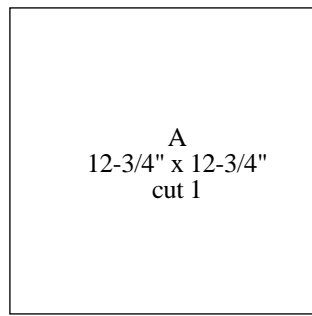

Assembly

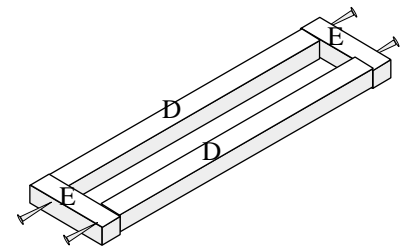
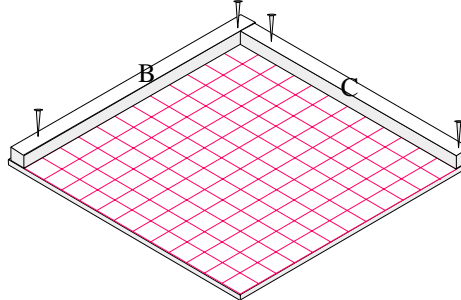
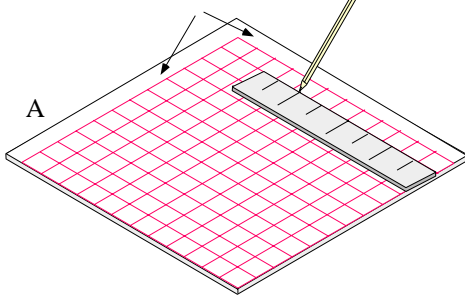

1. Using pencil or pen and ruler, draw lines 3/4" inside of 2 adjacent sides of the base. The frame will be placed in this area. From those 2 lines, draw lines at 1" intervals, forming a 1" grid.

2. Nail and glue frame parts B and C in place, as shown, maintaining a square corner.

3. Using glue and nails, assemble the frame "push bar", as shown. Again, make sure that the corners are square.

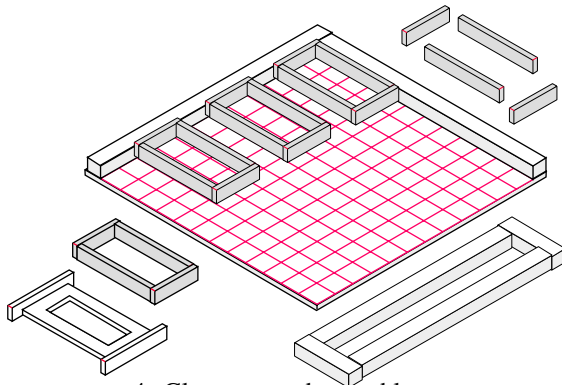

4. Glue parts and assemble inside the frame. The grid will help you keep the pieces straight. You can assemble several "like" pieces at one time.

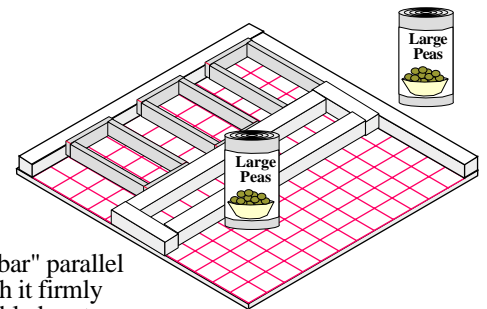

5. Keep the "push bar" parallel to side C and push it firmly against the assembled parts. Use anything with weight to hold the push bar in place until parts are dry. Canned goods you didn't want for dinner work well.

Trimming 1/8" Balsa wood or hardwood

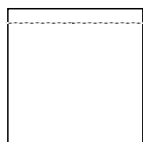

1. Using ruler and pencil make a line 1/8" from the inside edge to be mitered

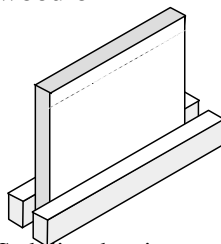

2 Stabilize the piece to be mitered with a clamp or other means

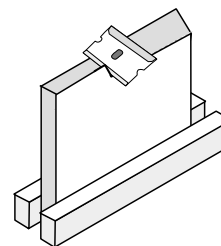

3. With blade, carefully trim from the top outside to the marked line. Alternately, the piece can planed or sanded.

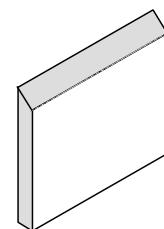

Trimmed on the inside

Accessories Only
1/4" Plywood

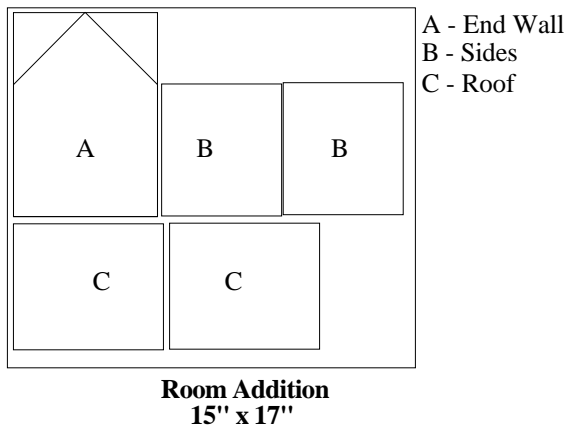
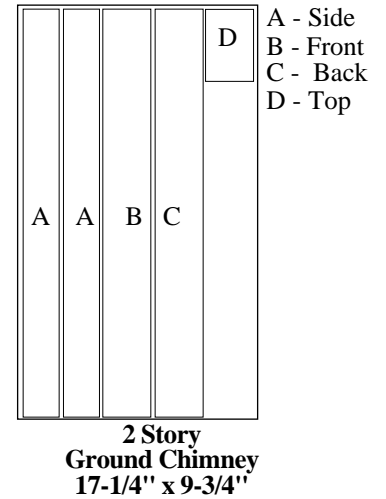
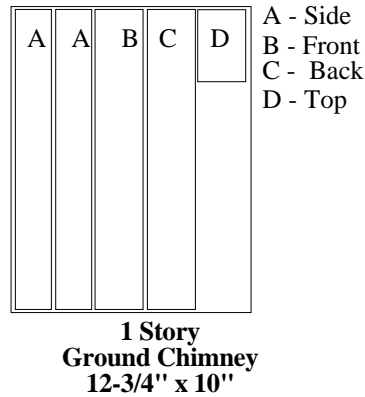
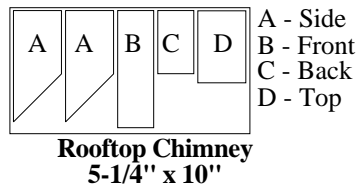
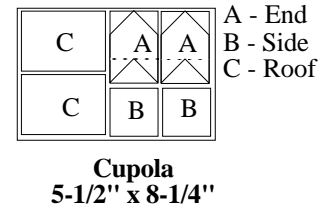
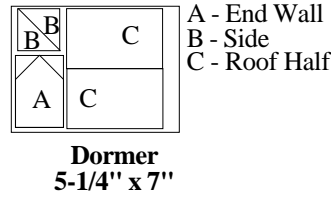
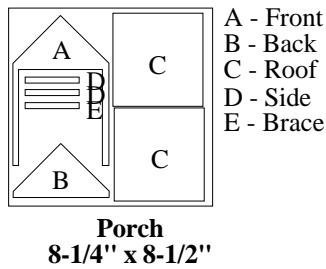

Note for House Layouts on following page:
 The space allowed for foundation and additions
 represents the Basic Foundation and room for
 Addition placements, according to the floor plans
 provided.

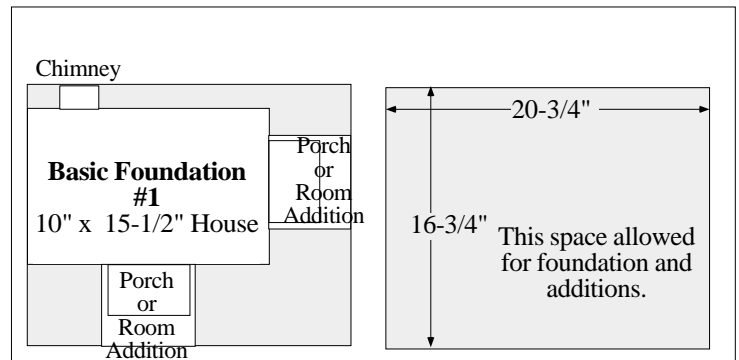

**1 Story
 Cut from
 1/4"
 Plywood**

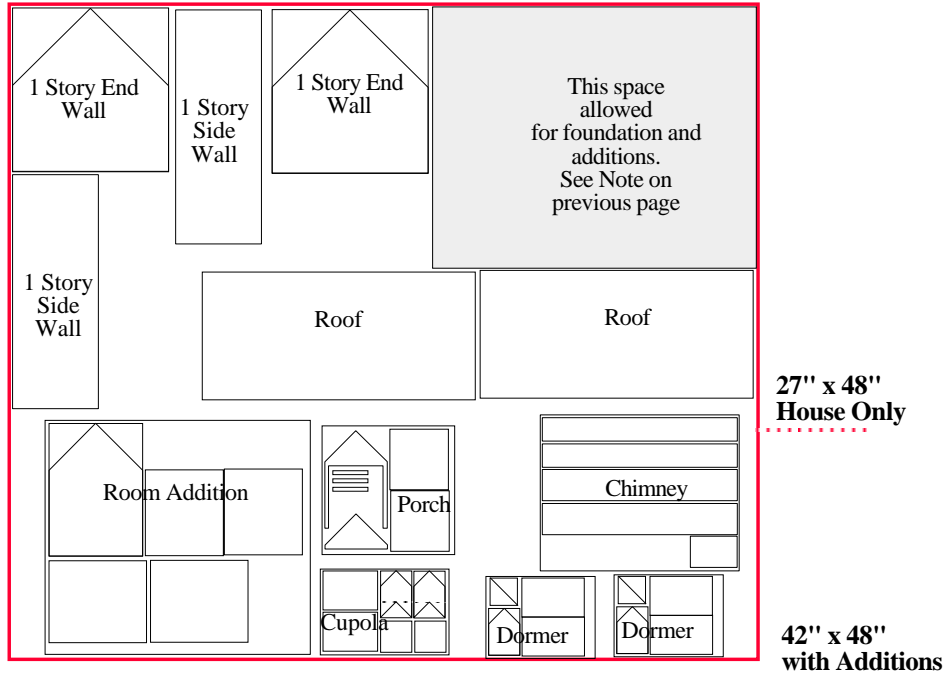

**2 Story
 Cut from
 1/4" Plywood**

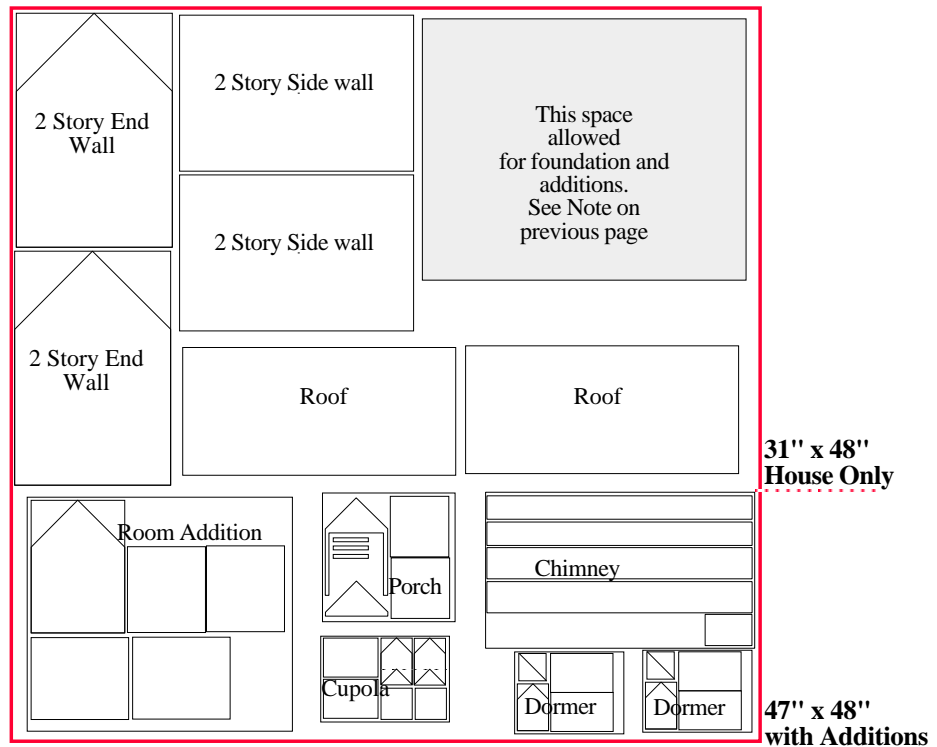

The Frame
 You will need to build a frame
 for which to attach the walls.

If your building will have doors which
 do not physically open, you can build
 a simple box for your wall braces.
 The windows and doors will fit
 into the walls.

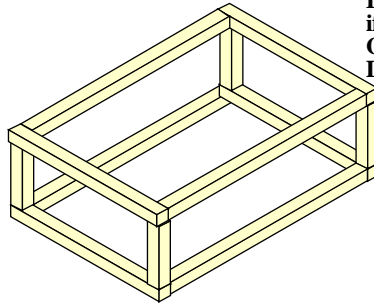

**Build this frame
 if you are using
 Garden Town
 Doors and Windows**

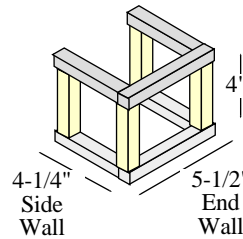
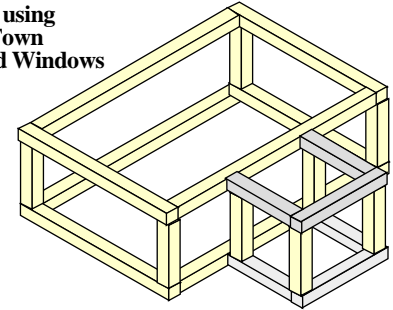

Room Addition

4 @ 4-1/4"	17"
2 @ 5-1/2"	11"
4 @ 4"	16"
Total	44"

If your house will have doors which
 do physically open, you will be cutting
 openings in the bottom frame.

Vertical Braces for:
 1 Story Houses and all
 Room Additions are 4" high.
 2 Story Houses are 8-1/2" high.

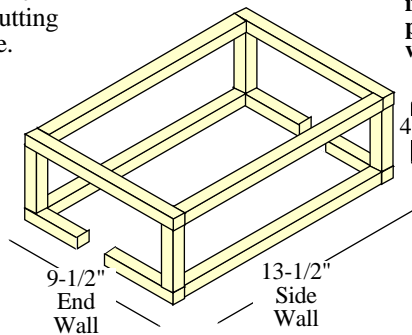

**Build this frame
 if you are using
 purchased doors
 which open**

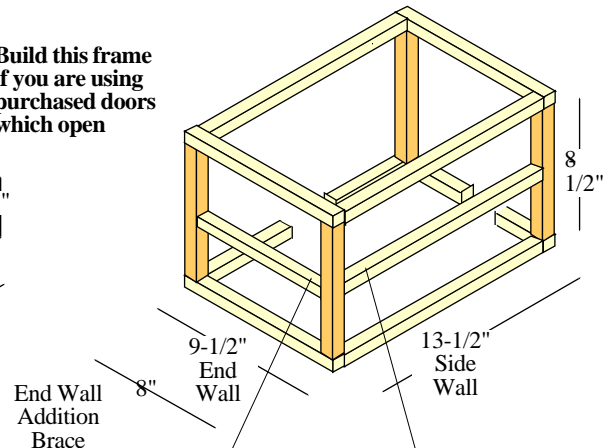

Two story houses with a room addition will need 1 extra horizontal brace.
 •Side wall brace will be the same length as the side wall frame.
 •End wall brace 1-1/2" shorter to fit inside the vertical frames.

Frame Assembly is shown on page 40.

1" Furring Strips for Framing 1 Story	
4 @ 9-1/2"	38"
4 @ 13-1/2"	54"
4 @ 4"	16"
Total for Basic House	108"
Addition Total	44"
	152"

1" Furring Strips for Framing 2 Story	
4 @ 9-1/2"	38"
4 @ 13-1/2"	54"
4 @ 8-1/2"	34"
Total for Basic House	126"
Addition Total	44"
1 @ 8" or	
1 @ 13-1/2"	13-1/2"
	183-1/2"

Conversion Inches = Feet	
12"	1'
24"	2'
36"	3'
48"	4'
60"	5'
72"	6'
84"	7'
96"	8'
108"	9'
120"	10'
132"	11'
144"	12'
156"	13'
168"	14'
180"	15'
192"	16'
204"	17'
216"	18'
228"	19'
240"	20'

Note: 1" Furring strips are nominally 3/4" square. If yours are different, make adjustments so that they fit in the same area as the assembly diagram indicates on page 40.

Roofs made from 1/4" plywood

There are two ways to assemble your 45° roof. Either way will allow the two halves to meet at the top smoothly.



Areas that need to be mitered in order to fit will be designated with this icon on the pattern. The specific mitering angle is noted on the pattern page.

Method 1 - Miter the Tops

The first and more professional procedure is to miter the top edges of the roof halves on the inside. One way you can do this is to cut out the roof with a jigsaw which has an adjusting base plate. Example:

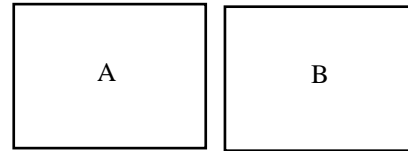

Both roof halves are each 3" high x 4" long

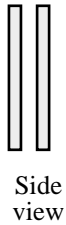

Side view

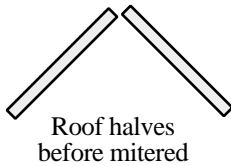

Roof halves before mitered

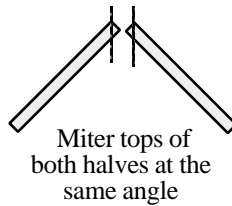

Miter tops of both halves at the same angle

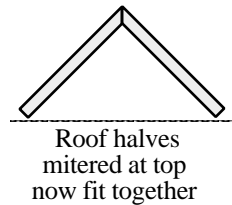

Roof halves mitered at top now fit together

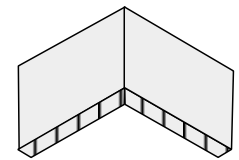

Top view of mitered roof

Optional:
 As a matter of taste, you may also choose to miter the inside bottom edge of the roof. If you miter the bottom of the house roof, you should also miter all addition roofs you will use with the house.

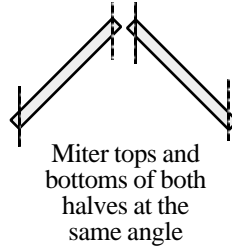

Miter tops and bottoms of both halves at the same angle



Side View with Top and bottom edge mitered

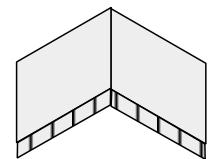

Side wall Option

Mitering the side wall will allow the roof to fit better.

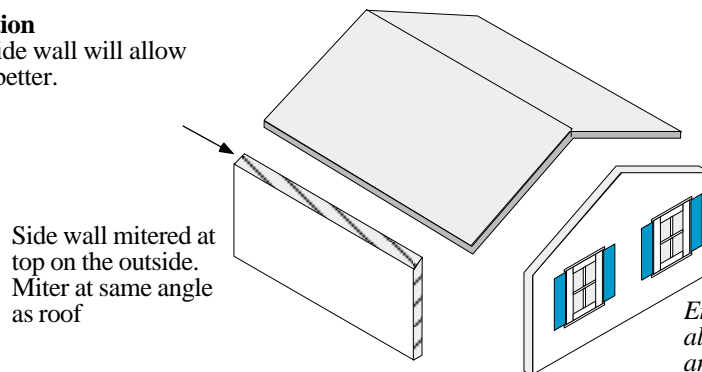

Side wall mitered at top on the outside. Miter at same angle as roof

End walls are already angled to fit the roof.

Method 2 - No Mitering

Add 1/4" to the height of one roof half only
 Example

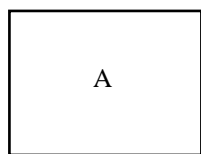

Roof half A is 3" high x 4" long

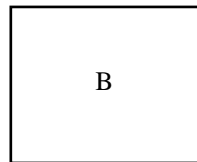

Roof half B is 3-1/4" high x 4" long



Side view



Fit roof halves together

Roofs made from 1/2" plywood

Add 1/2" to the height of one roof half only

No matter what depth of wood you use,
Always add the depth of the wood to one half only

Chimneys - Rooftop Type

The Back is always towards the peak of the roof and is shorter than the Front to accommodate the slope of the roof.

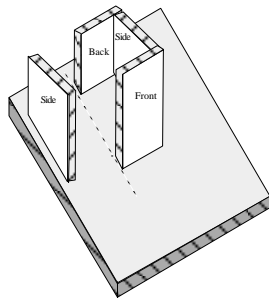
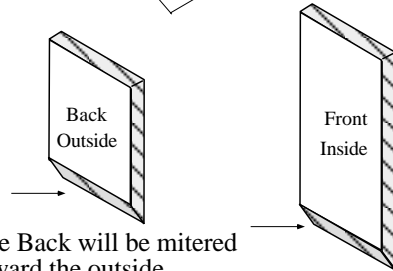
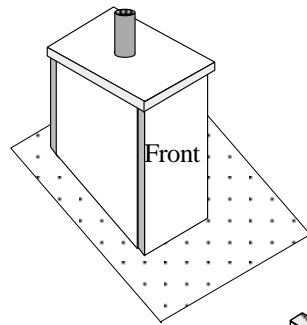
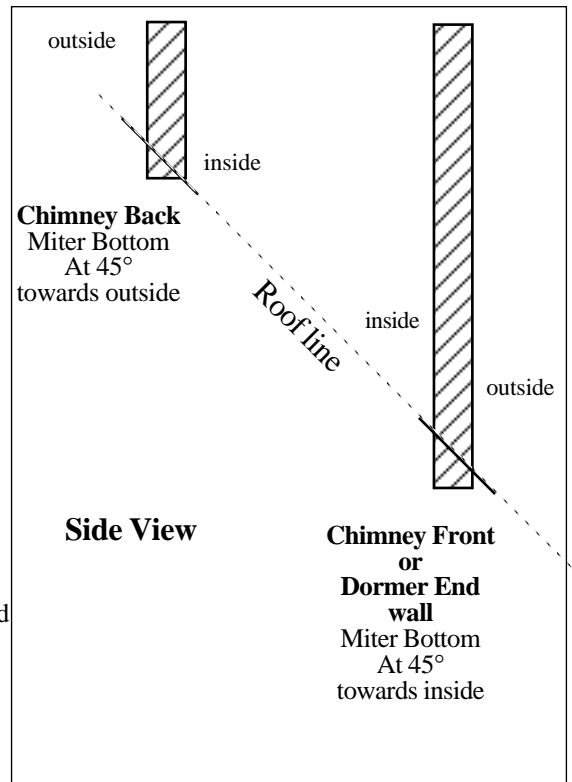

Illustration to show placement only. Chimney to be completed before attaching to roof.



The Back will be mitered toward the outside

The Front will be mitered toward the inside.
 Same as for Dormer End Wall



Dormers

Dormer Roofs

Miter in same manner as the main roof so that the tops will fit together smoothly.

If you have also mitered the bottom sides of the main roof, you'll want to miter the bottoms of the addition roof to correspond.

There is one additional step for Dormer Roofs.

In order for the angled edge to fit onto the main roof, miter the inside of the angled edge. Miter all three sides at the same angle.

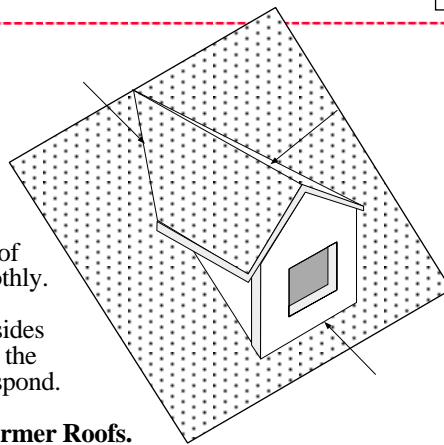

End wall is handled like chimney front.

Inside view
 Dormer roof half

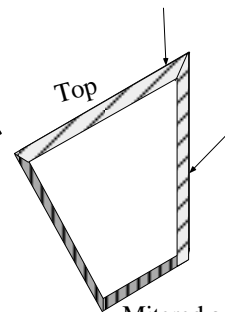

Mitered on top and angled side only

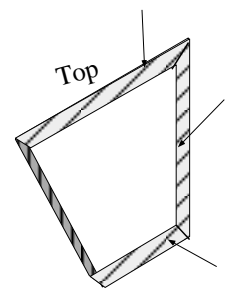

Mitered on top, angled side and bottom.

Porches

Any porch with an angled roof will need to be mitered in the same manner as Main roofs

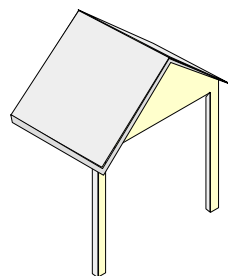

Roof halves will be mitered to fit each other at top

1

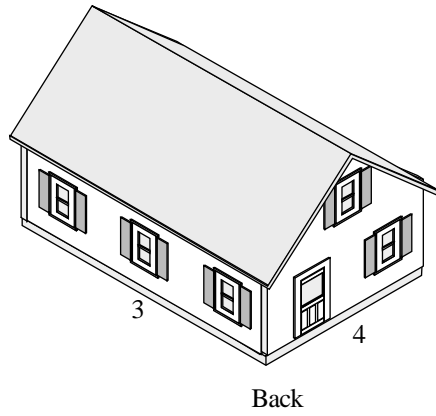
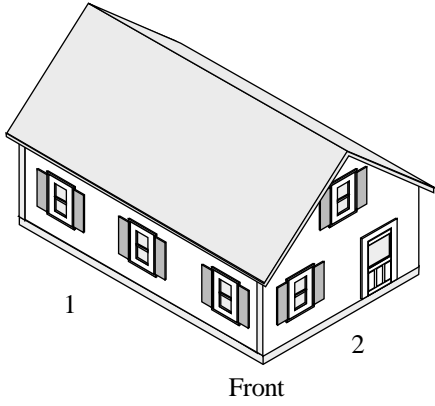

Use Foundation # 1
 See Planning the Walls
 for placement details

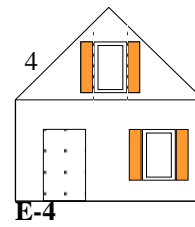
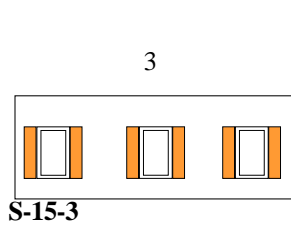
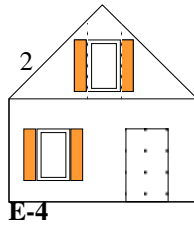
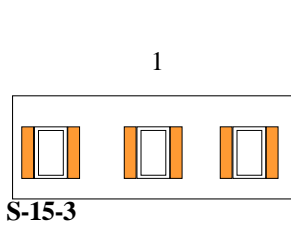
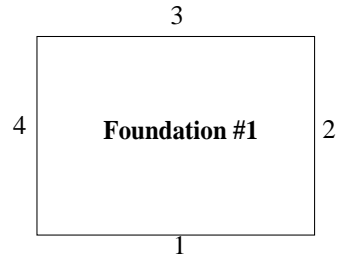

2

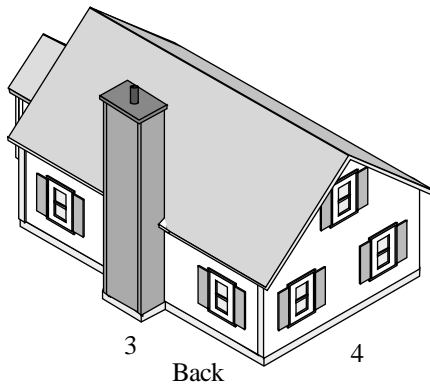
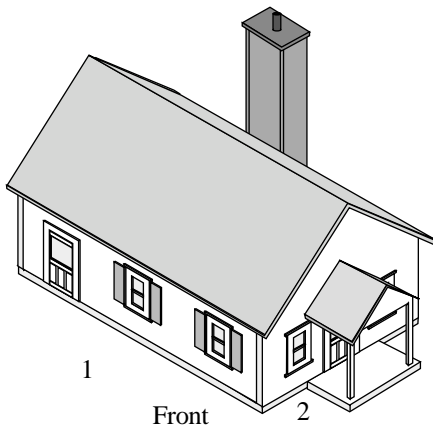

Use Foundation # 2
 See Planning the Walls
 for placement details

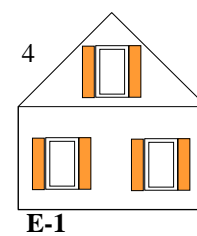
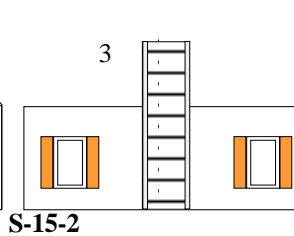
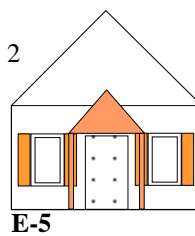
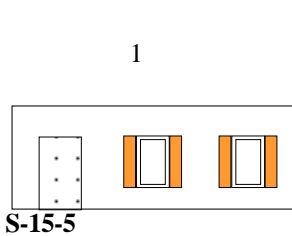
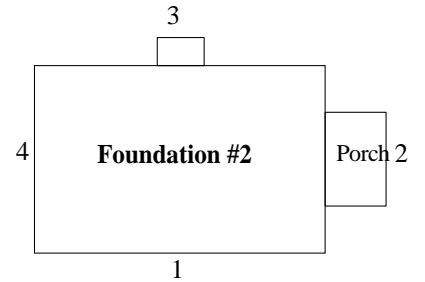

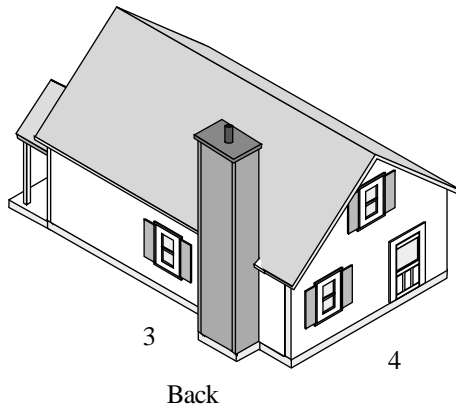
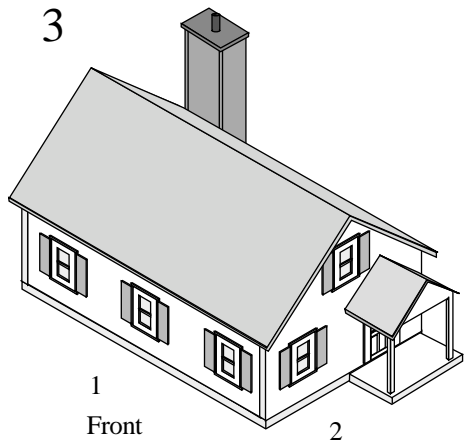

Use Foundation # 3
 See Planning the Walls
 for placement details

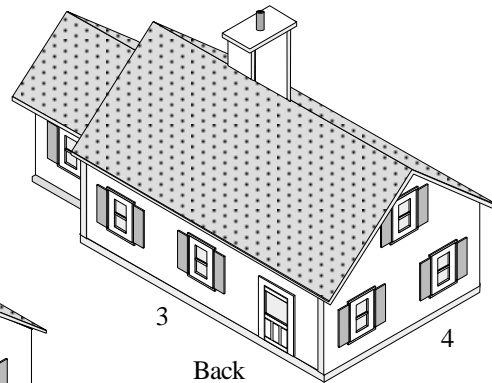
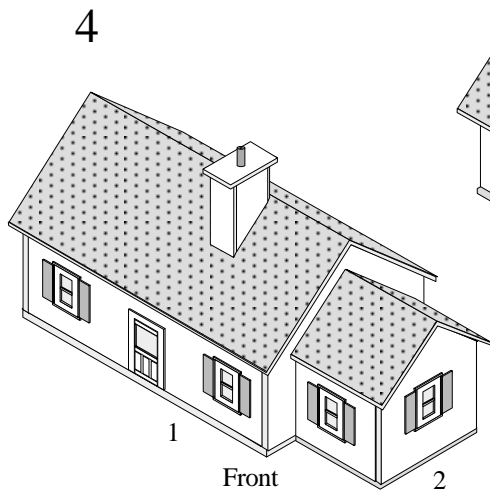
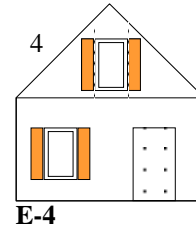
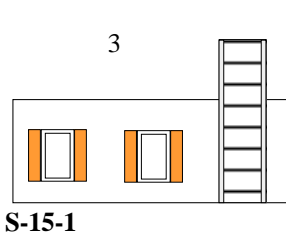
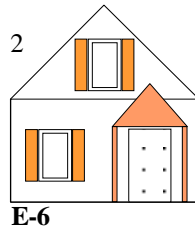
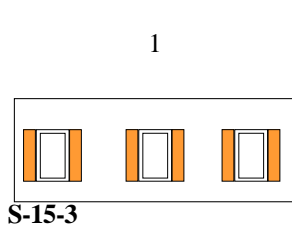
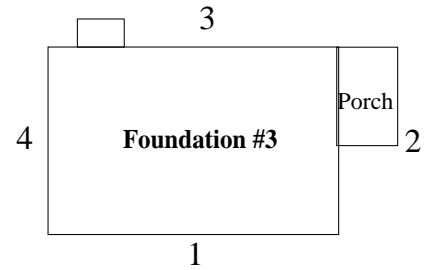

Use Foundation # 4
 See Planning the Walls
 for placement details

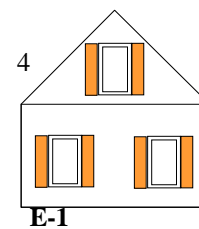
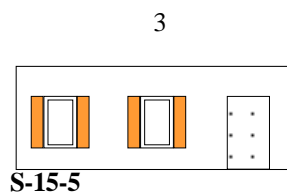
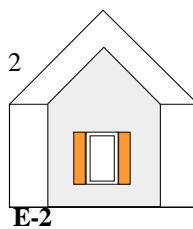
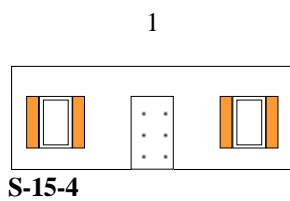
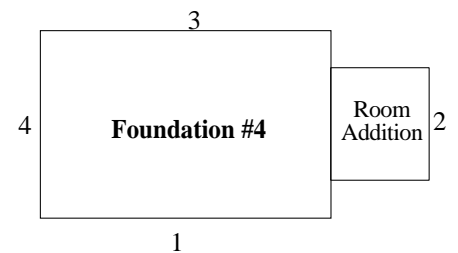

5

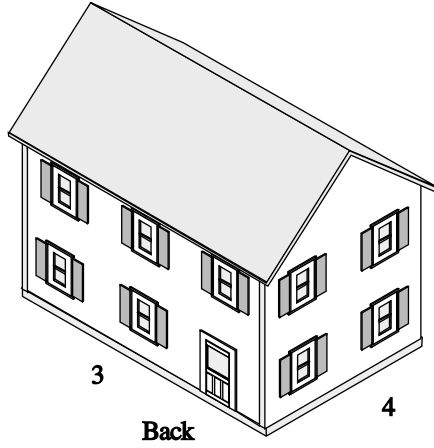
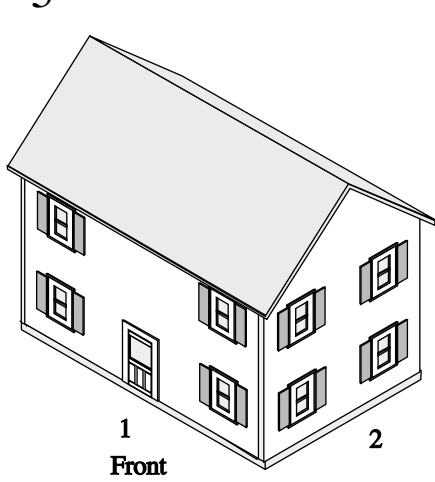

Use Foundation # 1
 See Planning the Walls
 for placement details

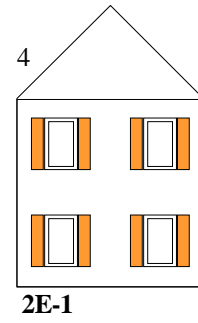
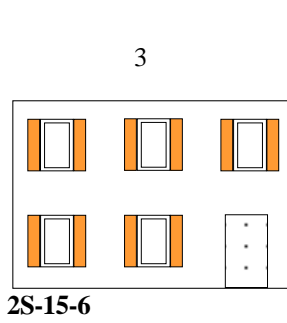
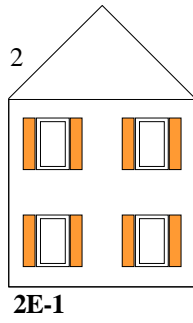
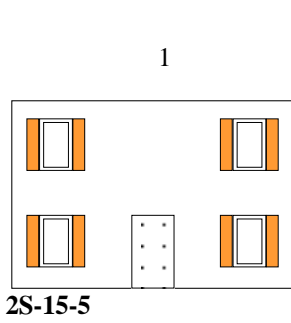
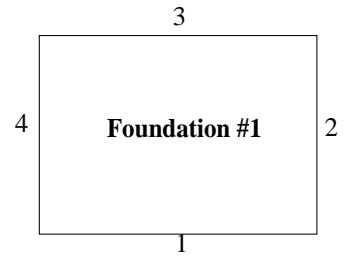

6

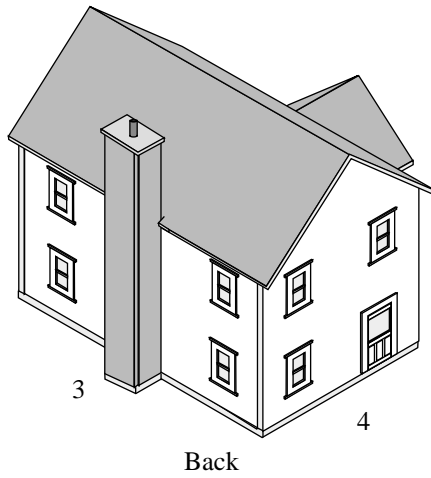
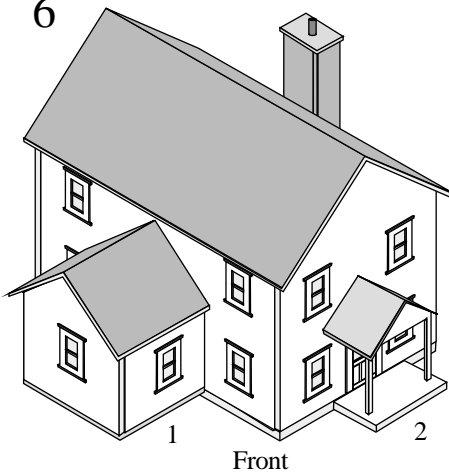

Use Foundation # 2
 See Planning the Walls
 for placement details

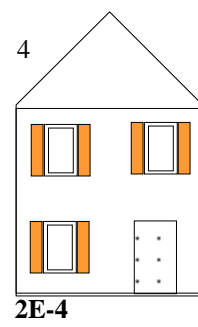
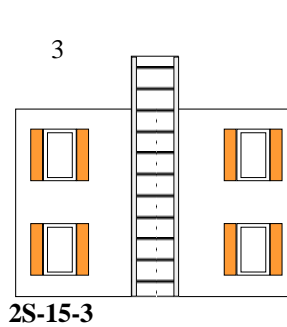
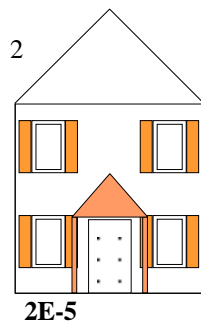
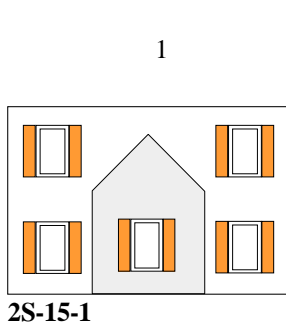
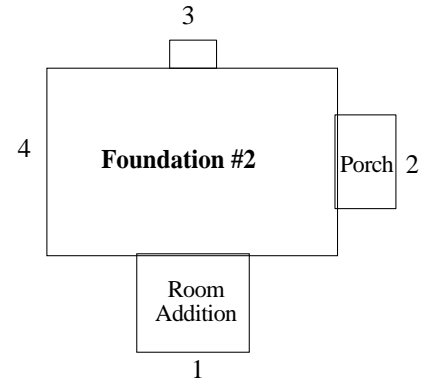

7

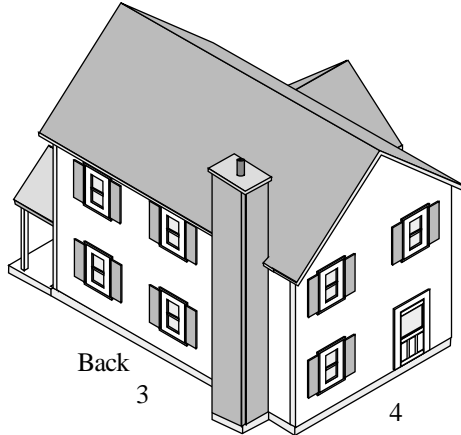
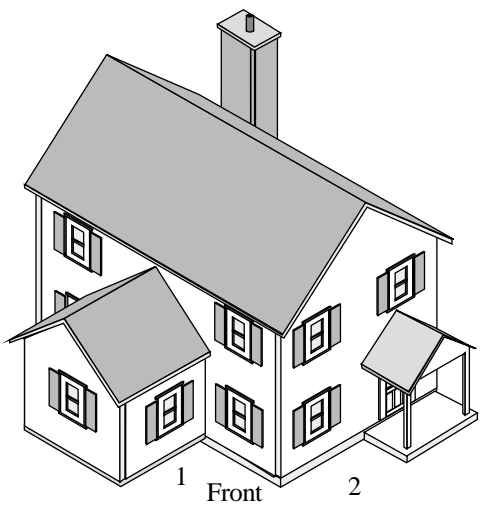

Use Foundation # 3
 See Planning the Walls
 for placement details

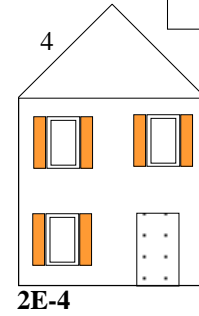
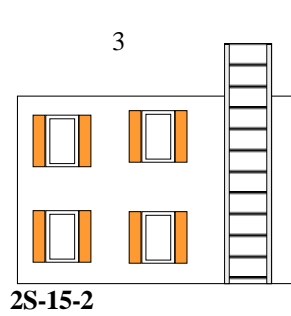
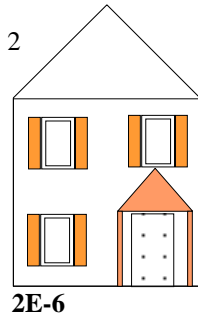
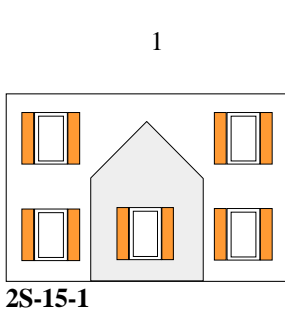
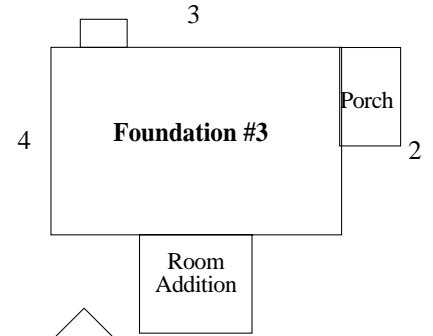

8

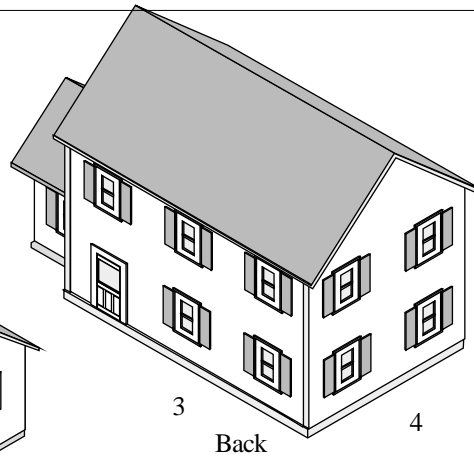
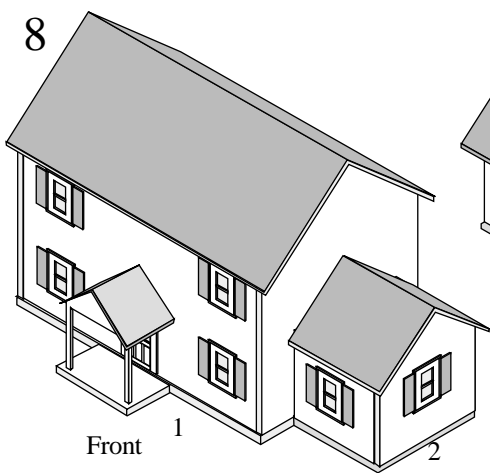

Use Foundation # 4
 See Planning the Walls
 for placement details

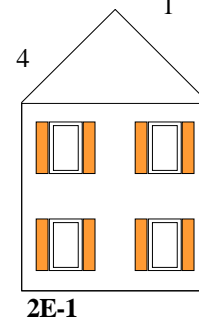
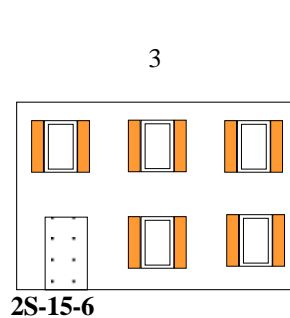
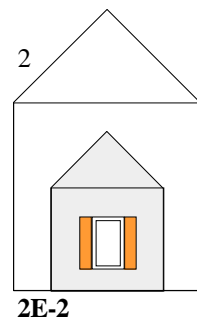
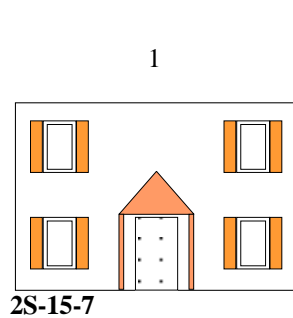
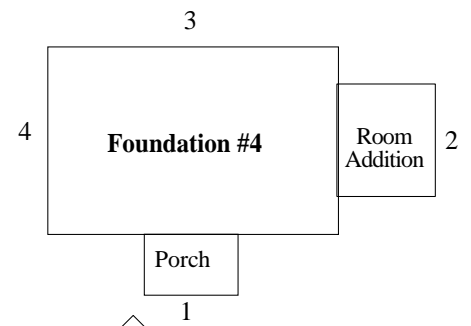

9

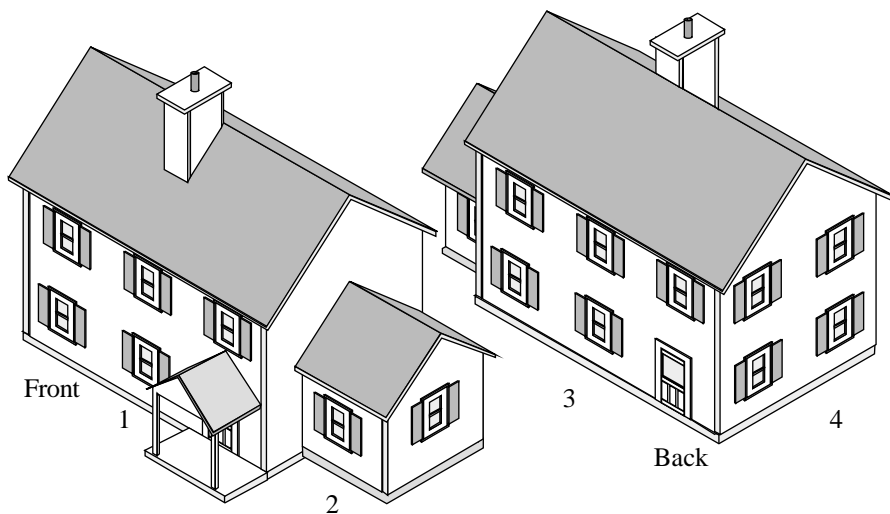

Use Foundation # 1
 See Planning the Walls
 for placement details

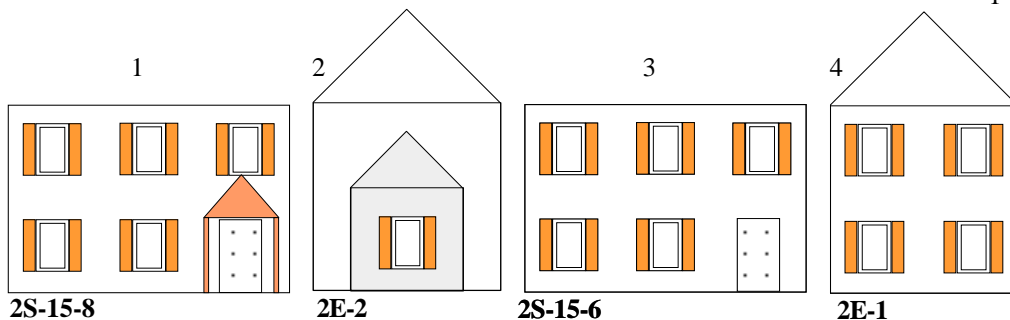
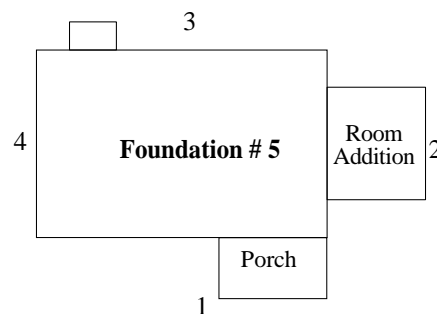

Doors and windows represented on the walls are from Kiva Design Garden Town Doors and Windows. Illustrations are to be used as a guide. If you use different size windows and doors, adjust your placements accordingly. Openings have to be at least 1" from the sides and 1" from the tops of the walls. (See Hints and Tips - Construction Scale Information)

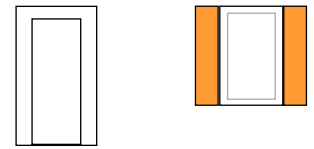

Door 2-1/4" x 3-7/8" Window # 1 1-3/4" x 2-3/4"

1-1/2"

Important Note: Spacer measurements shown in the wall illustrations are from a point to window or door frame. They are not the cutting lines for window or door openings. Mark the measurements on your walls. Then use the corresponding window or door templates which will show where to cut the opening. See page 37 for details.

Room Addition Walls Window and Door Options

One end of the side wall will be attached to the house wall. The other end will be assembled inside the end wall.

AE-1 AS-1

1 Story 15" Side Walls

Door, Window, Room Addition and Chimney Placements

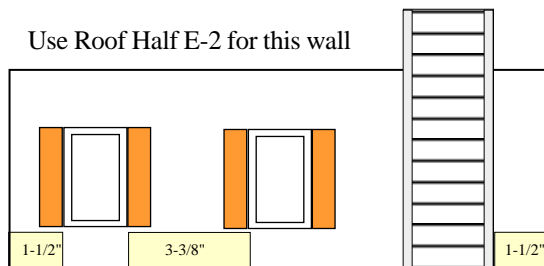

S-15-1

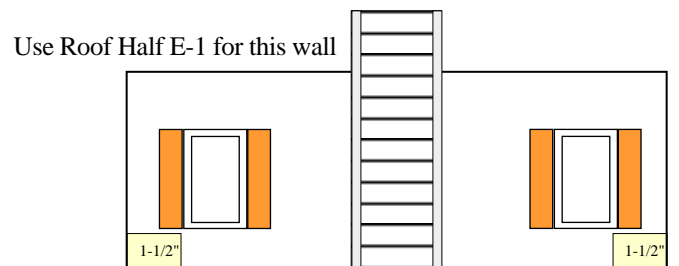

S-15-2

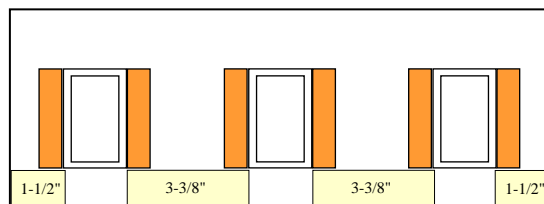

S-15-3

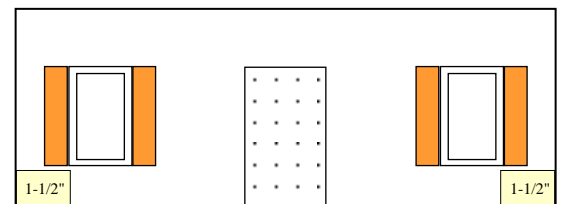

S-15-4

Door Centered - Porch will not fit on 1 story side wall

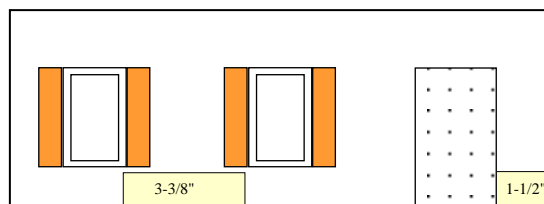

**S-15-5
RH Door**

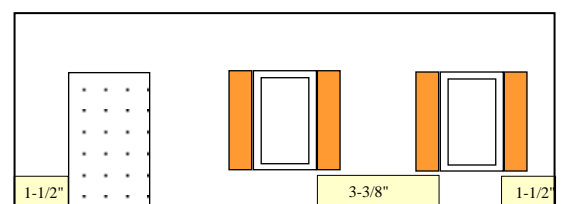

**S-15-5
LH Door**

Door to Side - Porch will not fit on 1 story side wall

1 Story End Walls

Door, Window, Room Addition and Chimney Placements

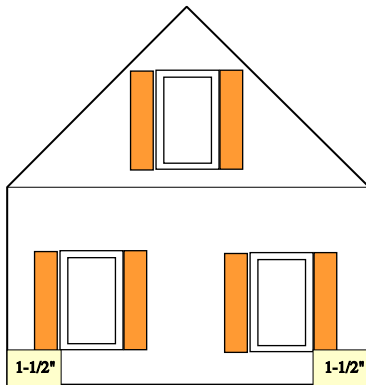

E-1

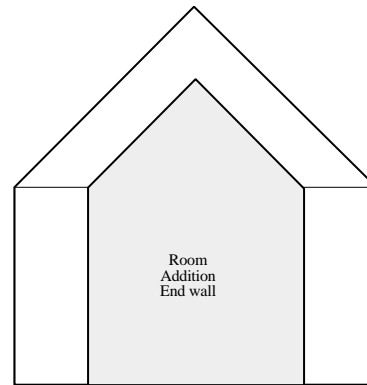

E-2

Room Addition
 Windows can not be effectively used
 on the house walls.
 See Room Addition walls for
 options.

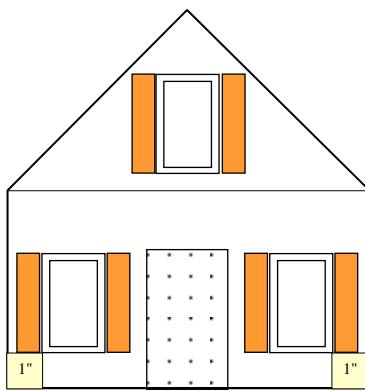

E-3

Door centered
 without Porch can have top window

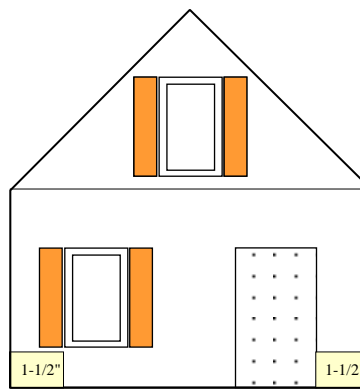

E-4

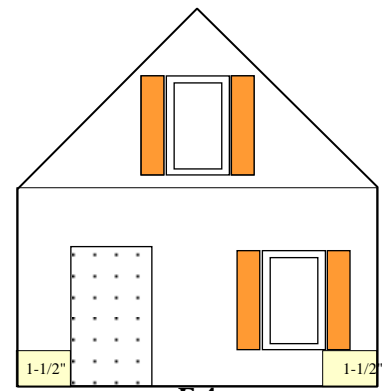

E-4

Door to side
 without Porch

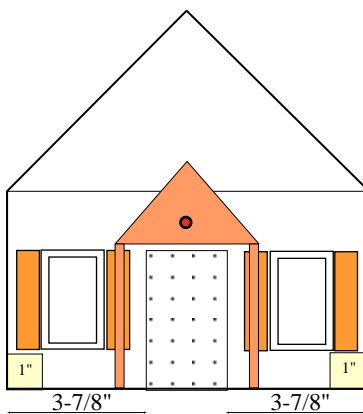

E-5

Door Centered
 with optional Porch
 Top window will not fit

Wall E-5
 Drill a very small pilot hole through the
 wall to attach the porch back. Hole will be
 centered at
 5" from each side and
 4-3/4" above floorline

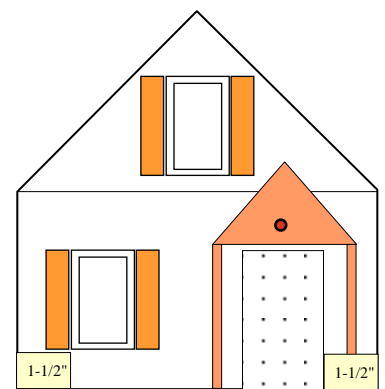

E-6

Door to Side
 with optional Porch
 and top window

Wall E-6
 Drill a very small pilot hole through the
 wall to attach the porch back. Hole will be
 placed at
 2-5/8" from the side and
 4-3/4" above floorline

**2 Story
 15" Side Walls**

Door, Window, Room Addition and Chimney Placements

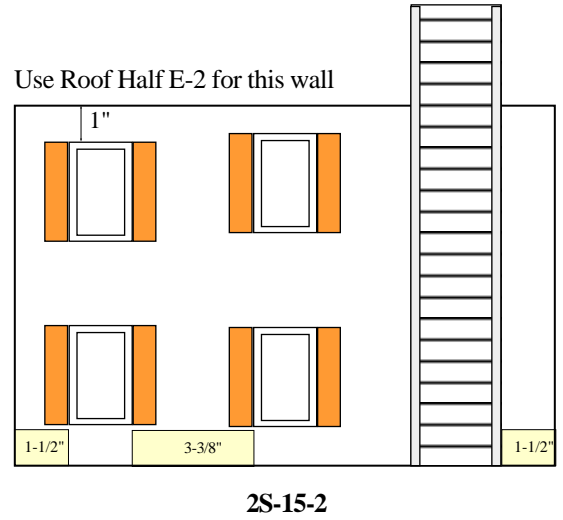
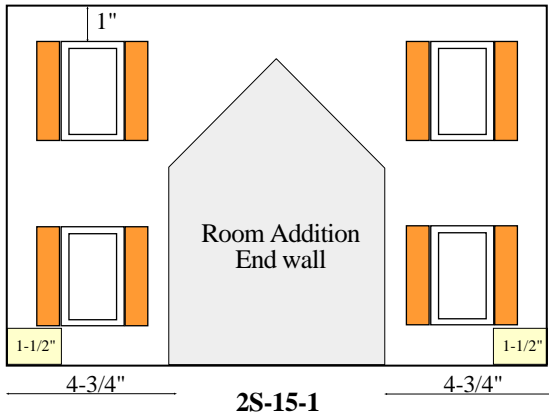

Use Roof Half E-3 for this wall

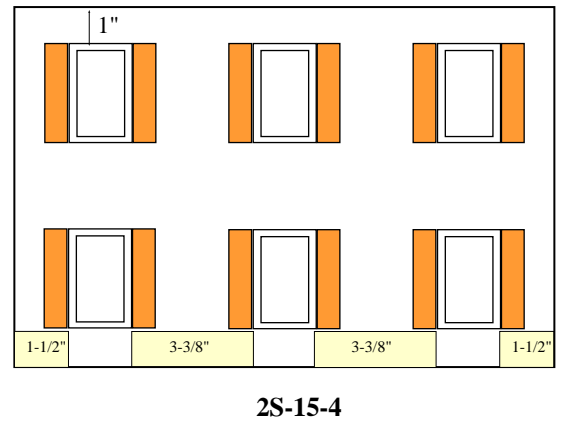
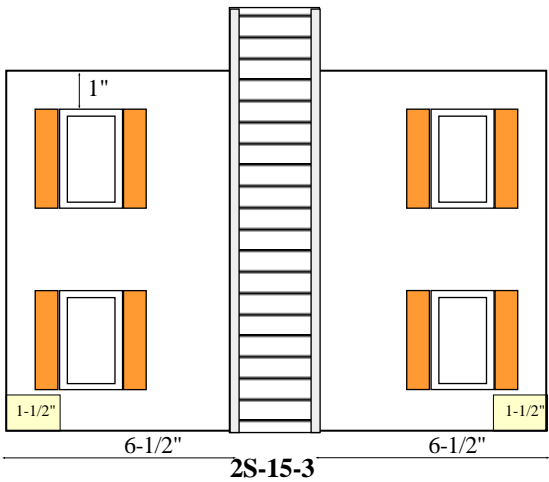

2 Story
15" Side Walls

Door, Window, Room Addition and Chimney Placements

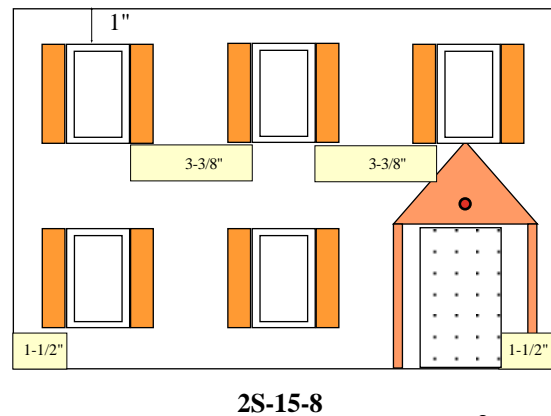
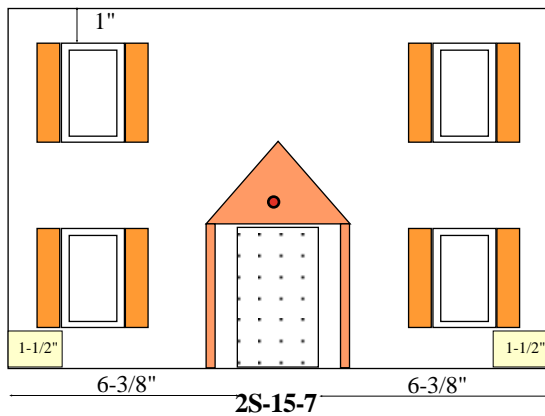
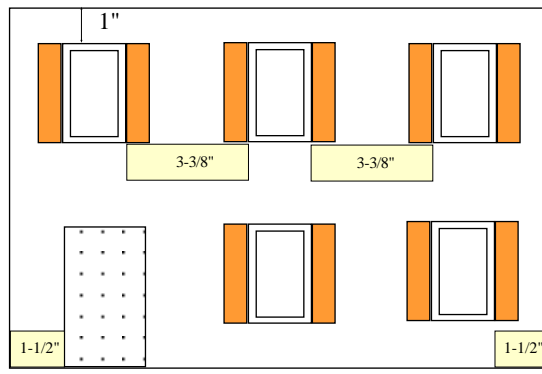
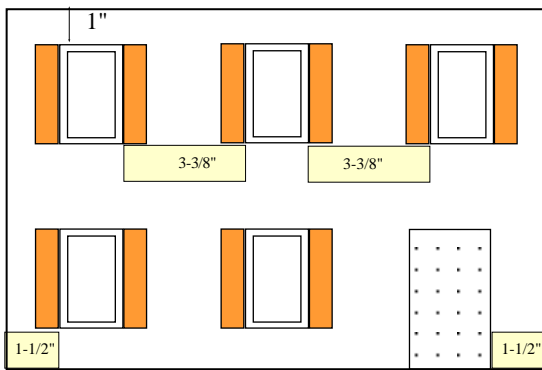
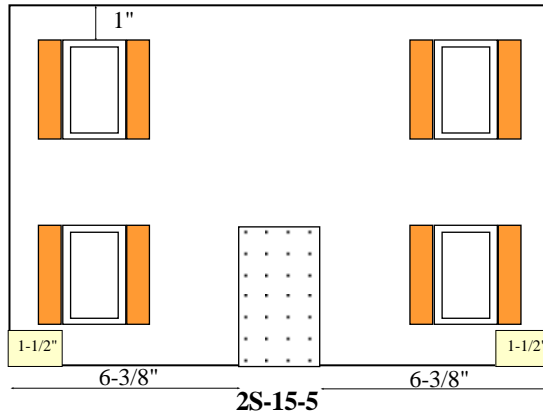

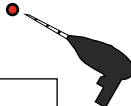

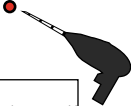
 Wall 2S-15-7
 Drill a very small pilot hole through the wall to attach the porch back. Hole will be centered at
 7-1/2" from each side and
 4-3/4" above floorline

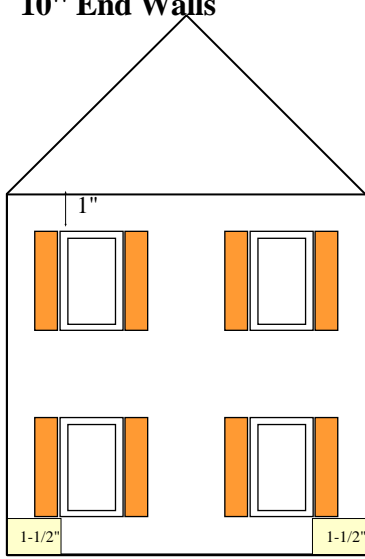

 Wall 2S-15-8
 Drill a very small pilot hole through the wall to attach the porch back. Hole will be placed at
 2-3/4" from the side and
 4-3/4" above floorline

**2 Story
 10" End Walls**

Door, Window, Room Addition and Chimney Placements

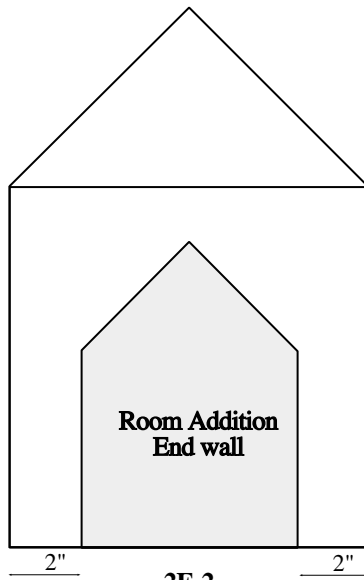

2E-1



2E-2

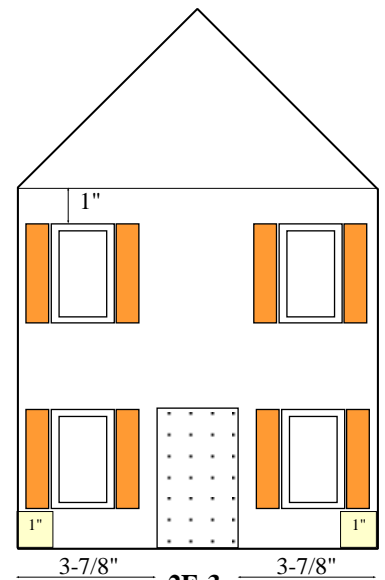

2E-3

Room Addition
 Windows can not be
 effectively
 used on the house walls.
 See Room Addition
 walls for options.

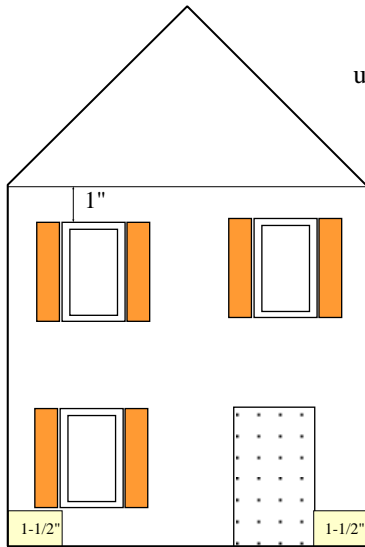

**2E-4
 RH Door**

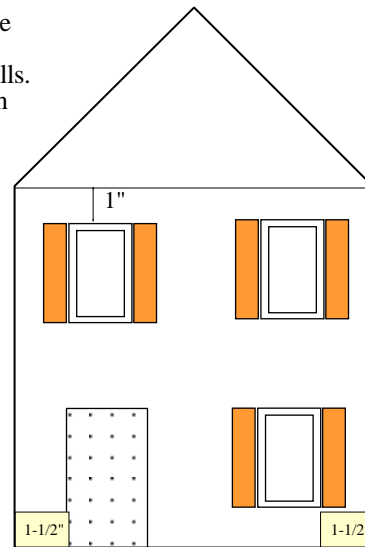

**2E-4
 LH Door**

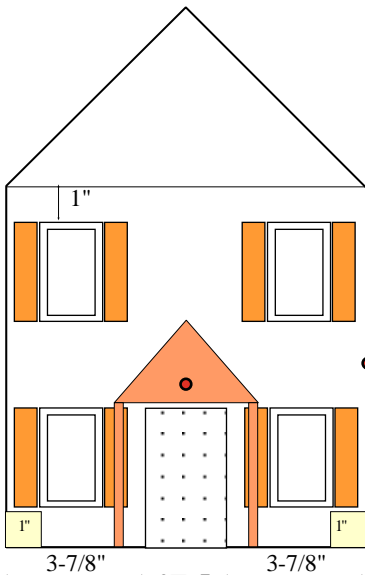

2E-5

Wall 2E-5
 Drill a very small pilot hole through the
 wall to attach the porch back. Hole will be
 centered at
 5"
 from each side and
 4-3/4" above floorline

Wall 2E-6
 Drill a very small pilot hole through the
 wall to attach the porch back. Hole will be
 placed at
 2-5/8" from the side and
 4-3/4" above floorline

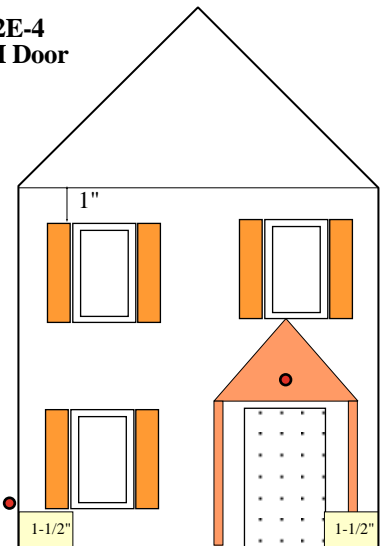

2E-6

**Roof top
Chimney**

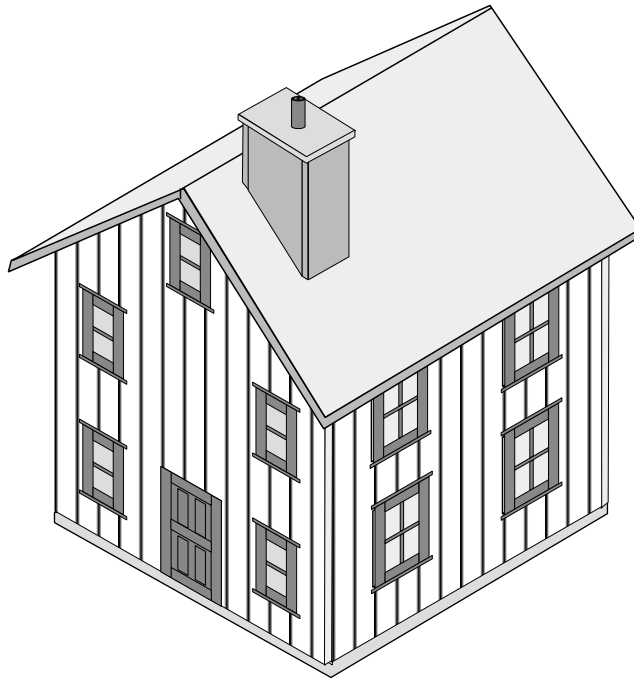

**Ground Level
Chimney**



Patterns

**Rooftop Chimney
 use with
 Top and Dowel**

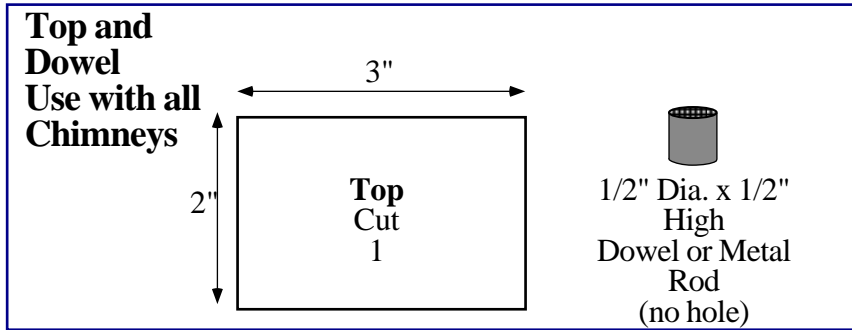
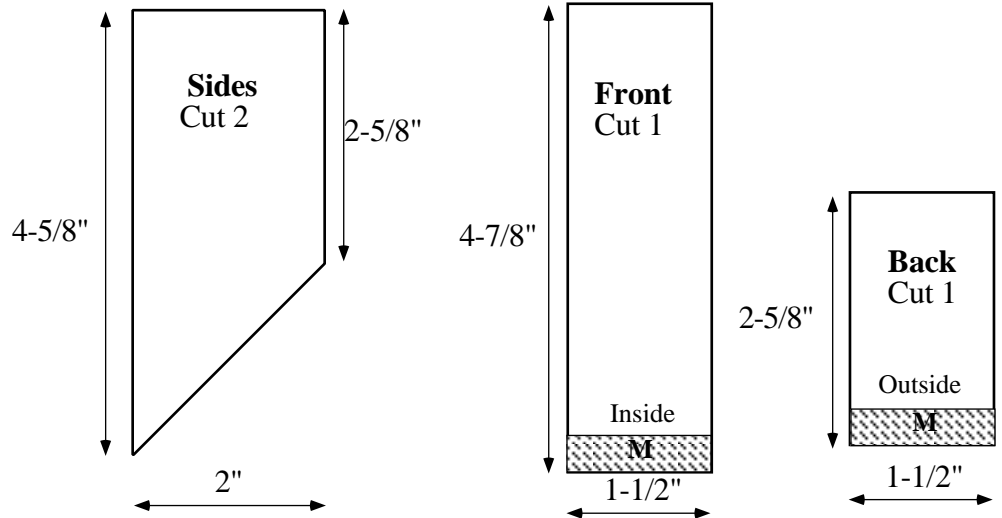

**Ground Chimney
 use with
 Top and Dowel**

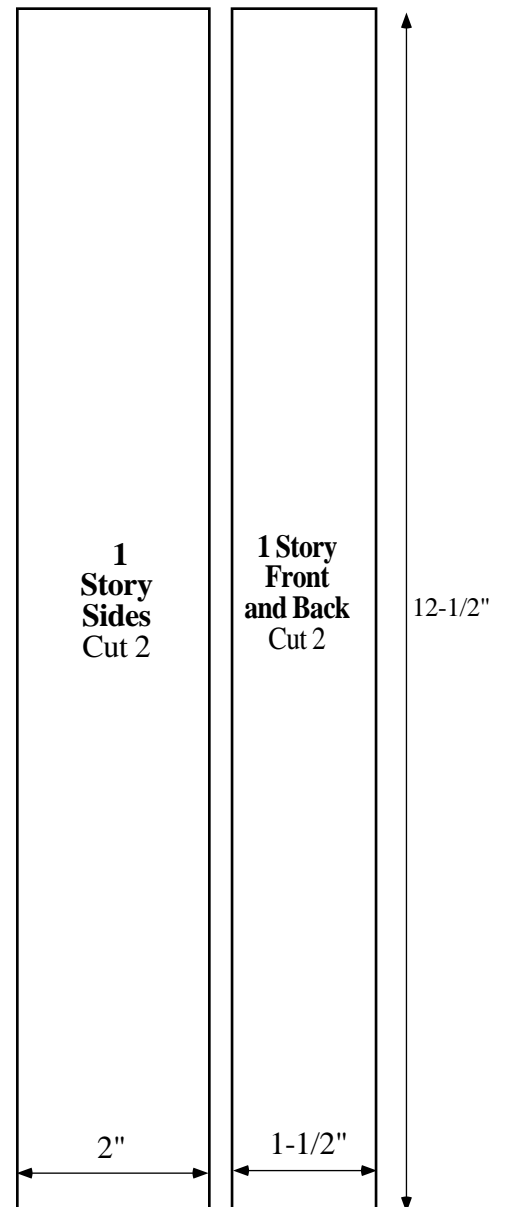
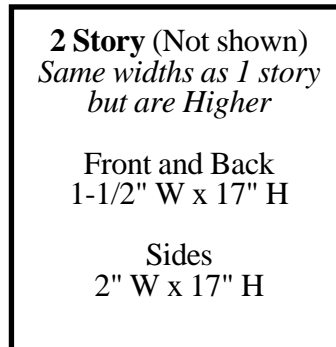
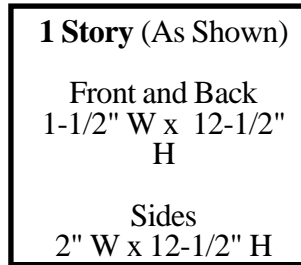

Assembly

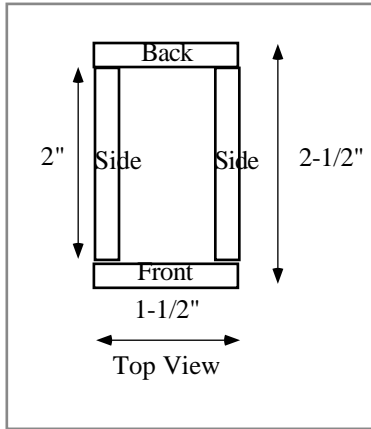

Note that the Sides are assembled inside of the Front and Back. This will form a 1-1/2" x 2-1/2" chimney.

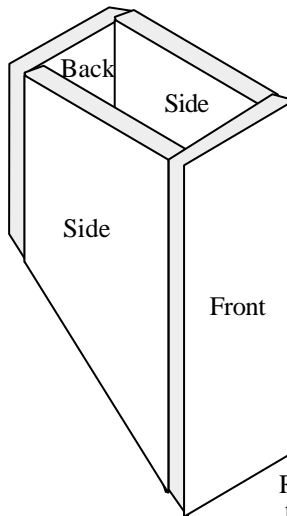

Run a bead of wood glue down the seams and securely nail or staple the chimney to form a box. Hint: You may want to clamp the wood in place before nailing.

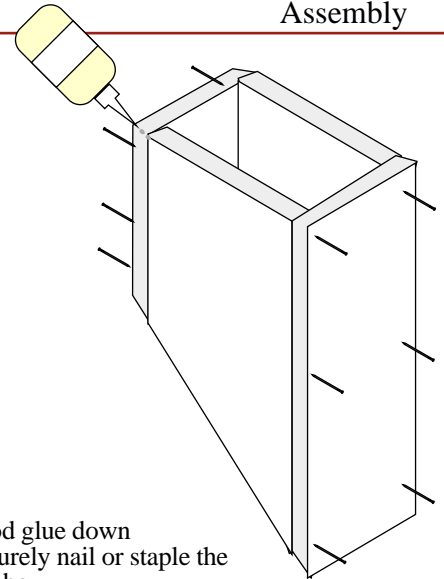

All Tops

2" X 3" with 1/2" diameter x 1/2" high dowel or metal rod (no hole) painted black. If building is to be used outside, you won't want rain water to run down a hole into the chimney.

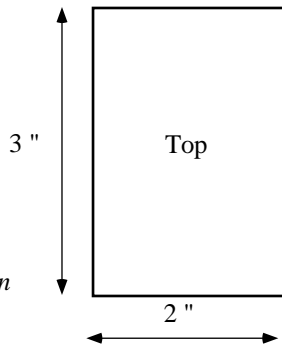

The Top will have an overhang of 1/4" on all sides.

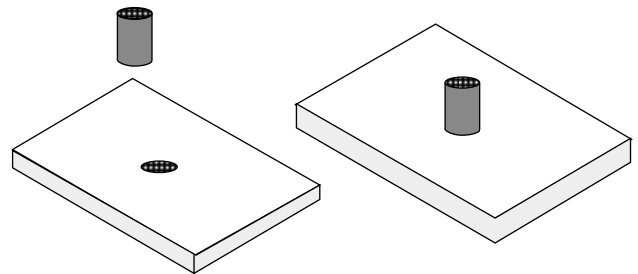

Drill a 1/2" hole in the center of the chimney top. Check to see that the rod will fit. It should be tight. Place a dab of glue inside the rim of the hole and insert dowel or rod.

Center and add the Top to the Chimney walls. Glue and nail or staple in place.

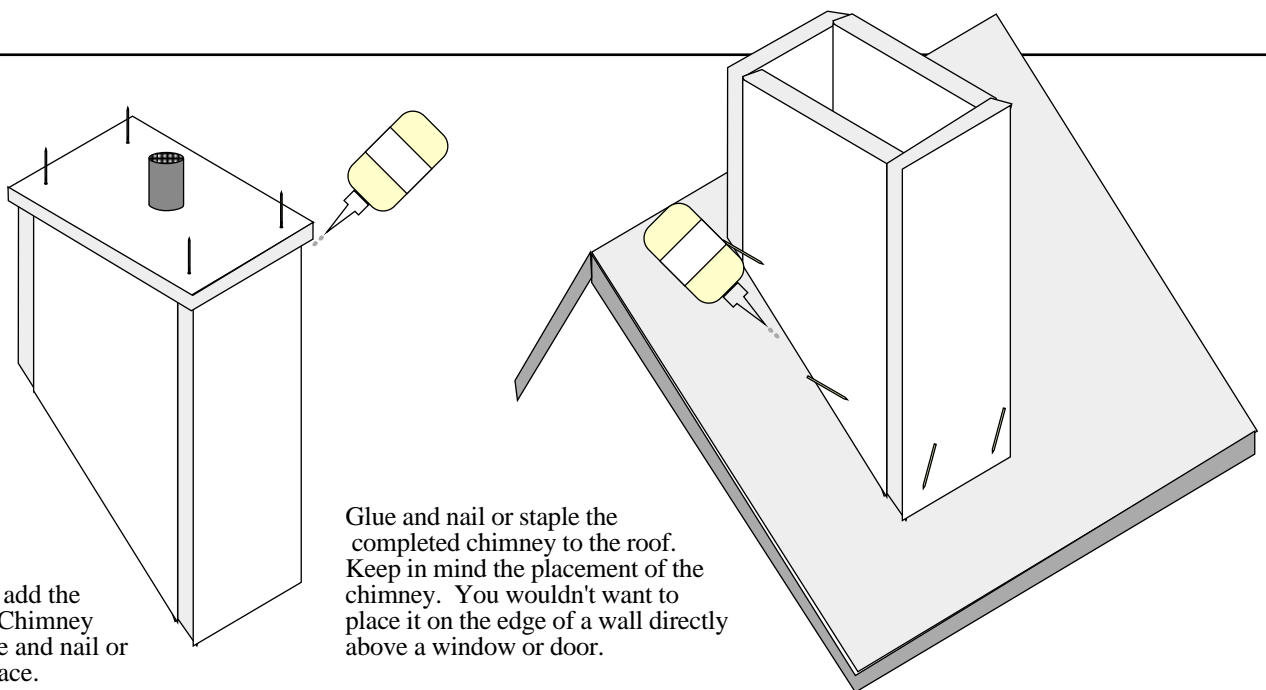

Glue and nail or staple the completed chimney to the roof. Keep in mind the placement of the chimney. You wouldn't want to place it on the edge of a wall directly above a window or door.

Assembly **Ground Level Chimney**
 The ground level chimney is assembled exactly the same as the rooftop chimney except there is no mitering.

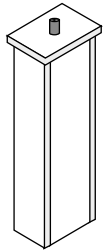

In order to get the chimney to fit up against the building, you will have to cut out a space on your roof for the chimney to slide into. Cut this notch before assembling the roof. Measure and mark where you want your chimney. This will be in the same position vertically as the foundation addition for the chimney.

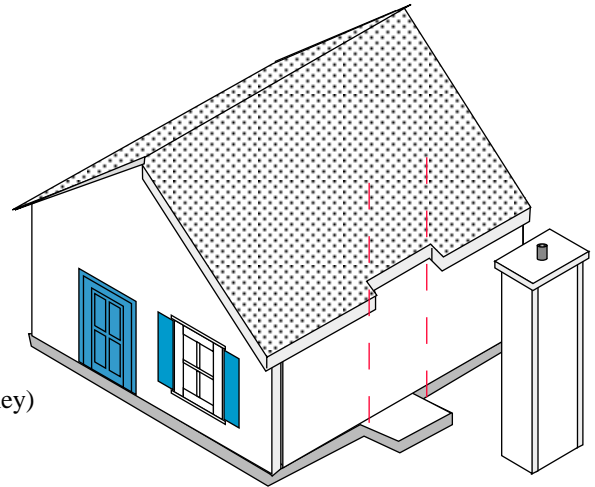

The notch will be 2-1/2" wide (width of the chimney) x 1/2" deep (or the depth of the overhang.) You may have to sand a little off to get a snug fit.

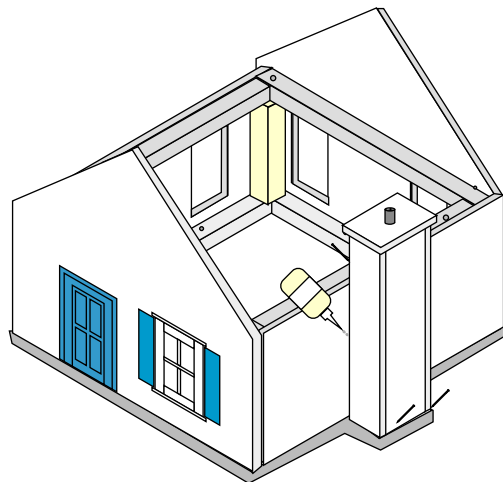

The Chimney should be installed against the house before attaching the roof. Use your wood glue and nail or staple chimney in place to the side walls (from inside of house) and the foundation.

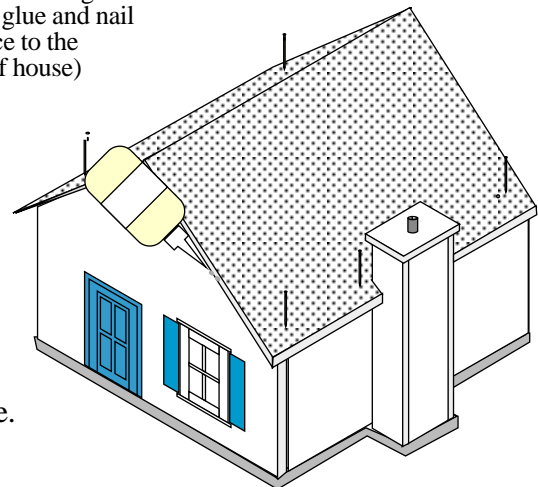

Add the roof and attach in place.

Optional ideas

Experiment with some scrap pieces before you begin on your chimney.

1. If so inclined, you could use a bit of ready mix concrete (just add water) which is usually used for patching. Rough up the sides and the top of the chimney and cover them with a thin film of the concrete. You may have to let it dry and go over it a couple of times in thin films to build up the desired layer. The top could be "flat" (no pattern) You can use an old sponge, brush, towel or whatever to brush the damp concrete for a rough finish or a specific pattern. The concrete can be painted or left natural.

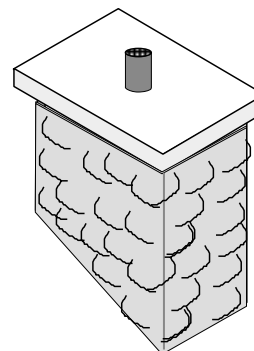

2. Gather up some small stones or pebbles of like sizes and using epoxy, attach them to the chimney sides. Fill in the "gaps" with a thin layer of concrete, let dry for a little bit and brush the residue off the stones before it hardens. Cover the top piece with a layer of the concrete.

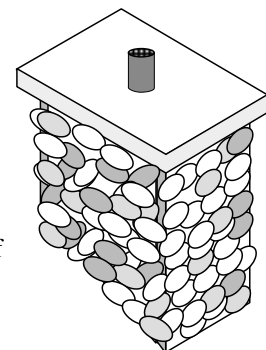

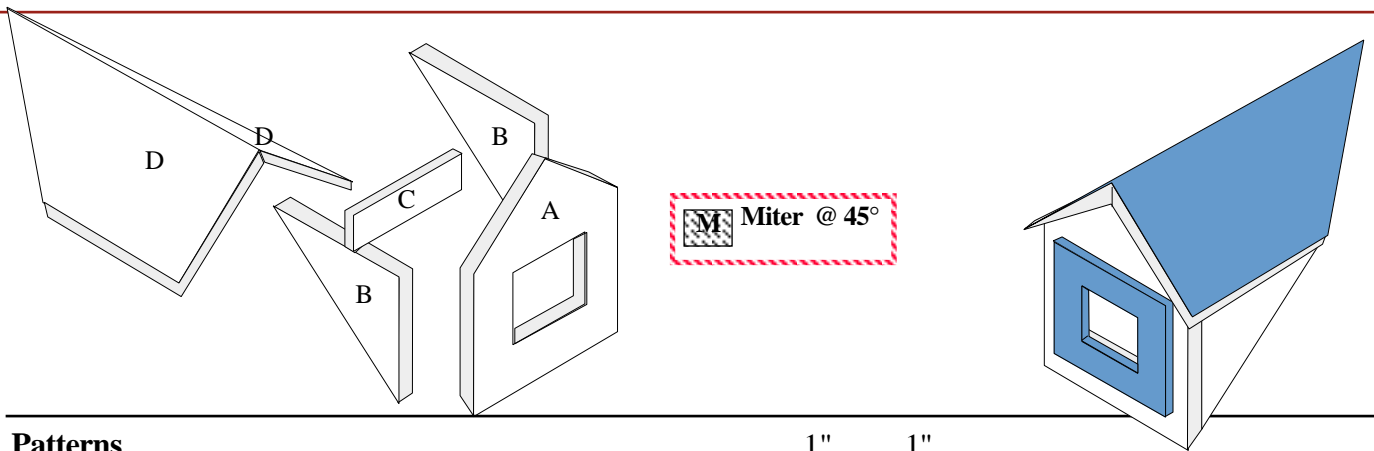

Patterns

A - 2" Wide x 3" High (center) and 2" High (side)

- Begin with a rectangle 3" High x 2" Wide
- Measure and mark the top center (1" from each side)
- Measure and mark 2" up from the bottom on both sides
- With ruler, draw your lines between the x's, forming the roof line.
- Cut out 1 End Wall
- Cut out window opening prior to assembly (See Dormer Window)

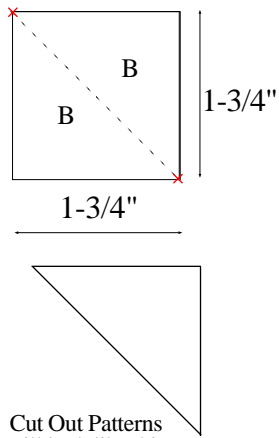
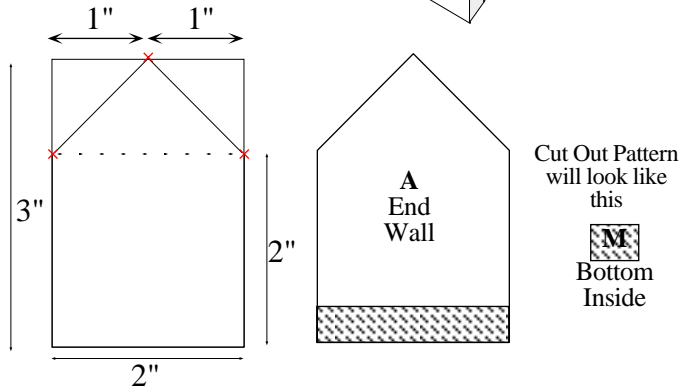

B - Dormer Sides

- Begin with a rectangle 1-3/4" High x 1-3/4" Wide
- With ruler, draw an angle from the top Left Hand Corner to the bottom Right Hand Corner.
- Cut out 2 Side Walls
- The two halves will make 2 side walls*

C - Inside Brace
 1/2" x 1-1/2"
 Cut 1

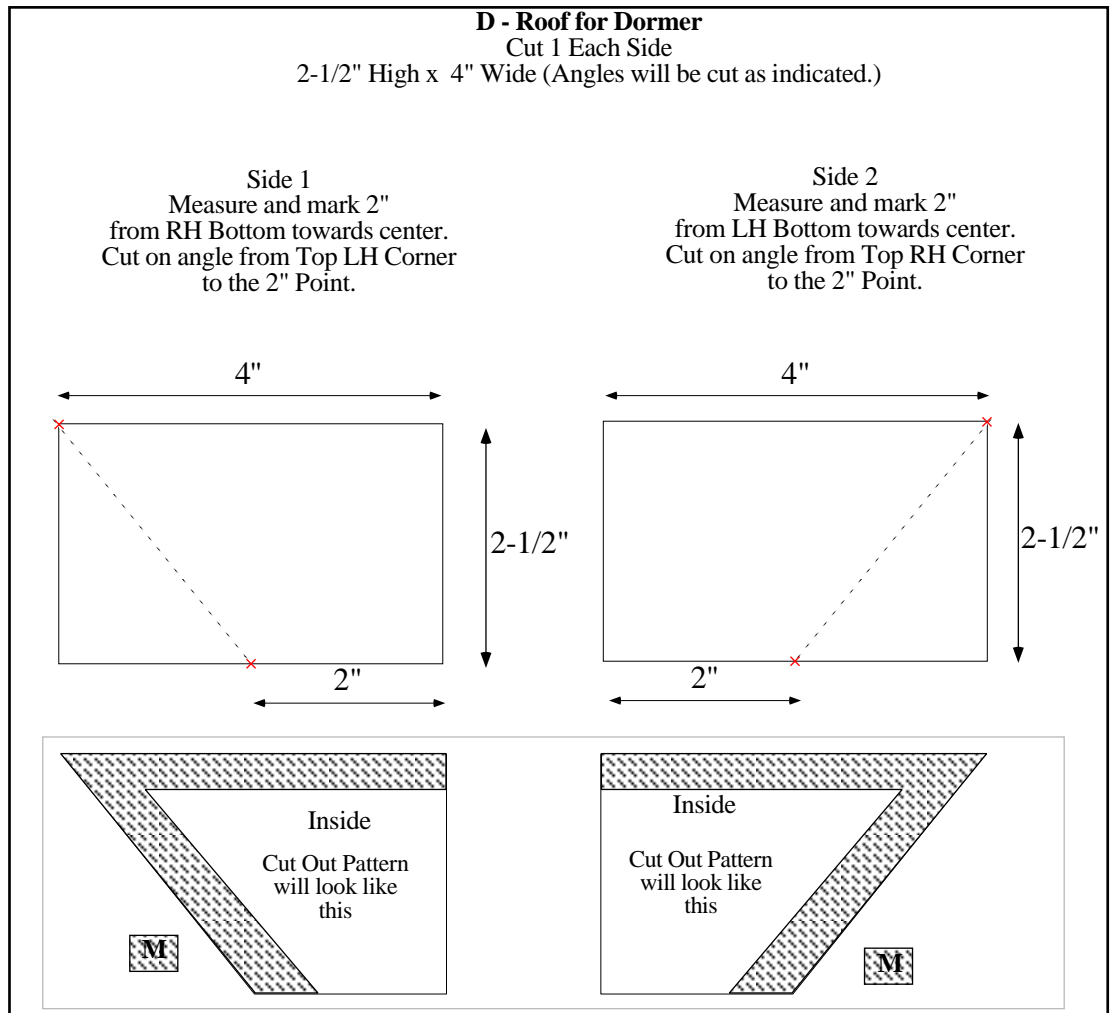

Assembly

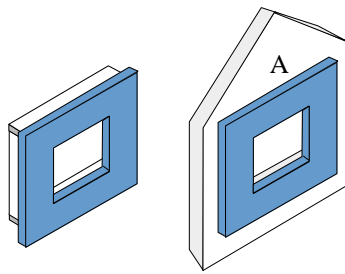

Front

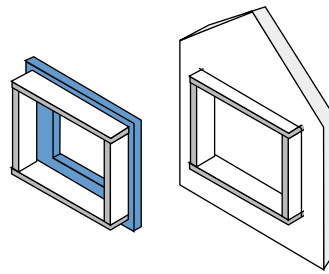

Back

1. Window opening will have to be cut prior to assembly. It will probably be easier if you also go ahead and install the window, as it should be in place prior to adding the roof.

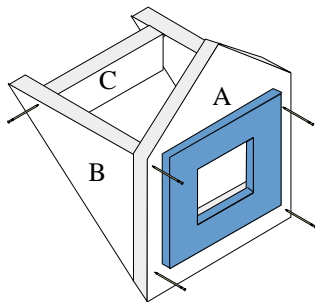

2. Note part A (End) is assembled on the outside of part B (Sides). Part C (brace) fits inside the sides. Lightly Glue and nail or staple the sides, end and brace together as illustrated

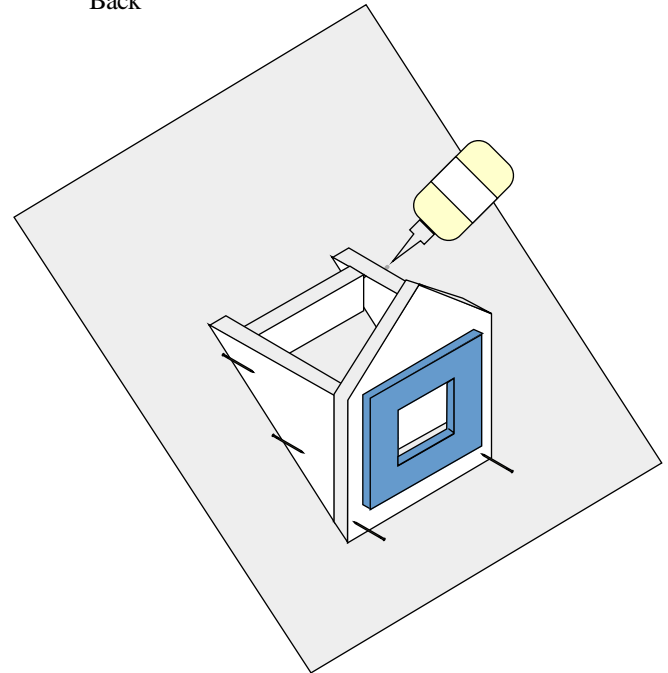

3. Attach the dormer to the roof of the house, again using a light bead of glue and nails or staples. Run a bead of glue along the top exposed wood of the dormer, where the roof will fit.

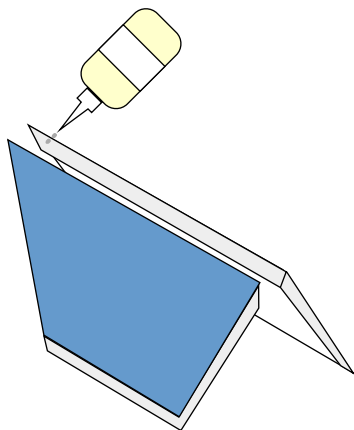

4. Run a bead of Wood Glue along the top inside mitered sides of the dormer roof

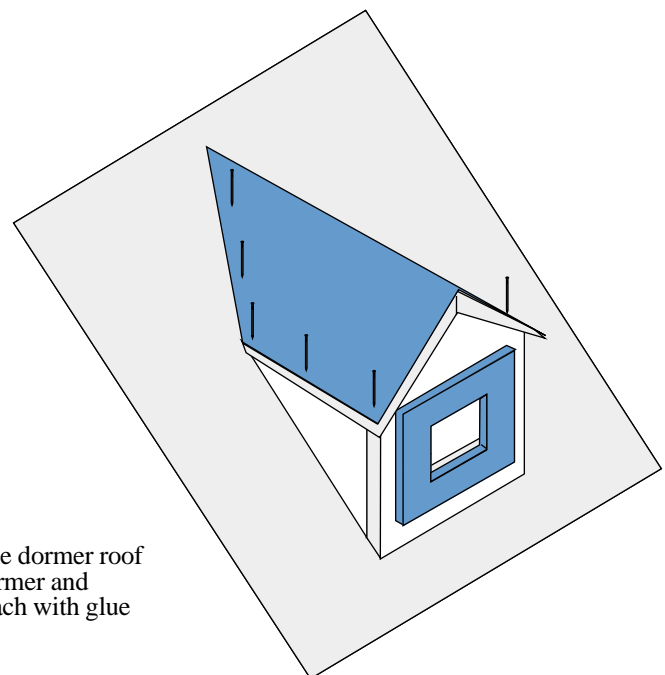

5. Center the dormer roof on to the dormer and securely attach with glue and nails.

Can be used with
 1 Story building (end wall only)
 or
 2 Story building. (any wall).

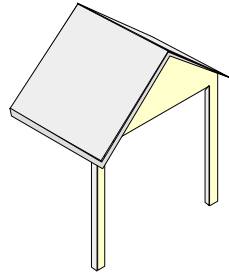

Patterns

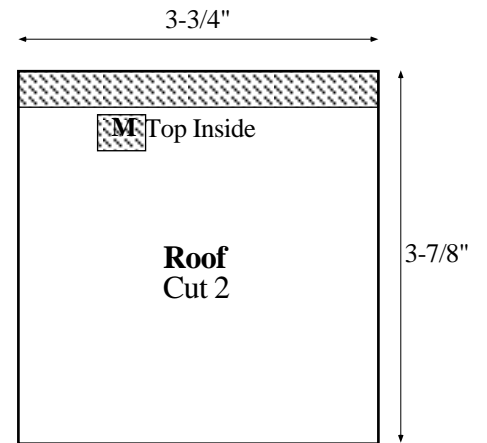
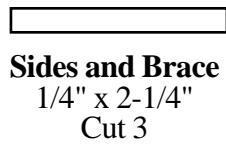
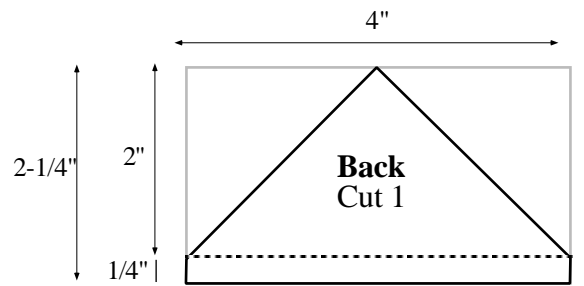
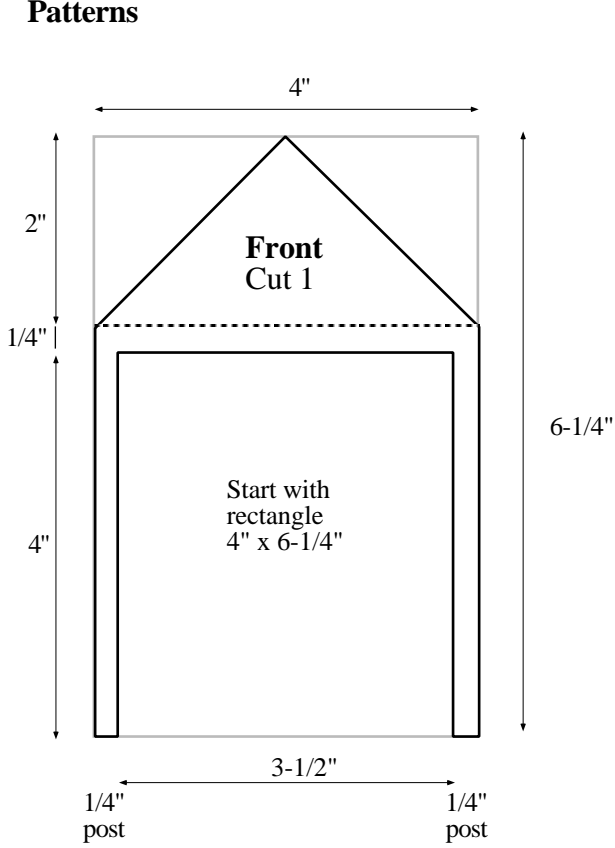

Assembly

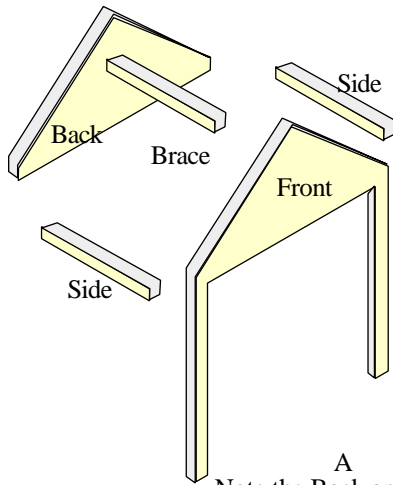

A
 Note the Back and Front are assembled on the outside of the Sides and Brace. Glue and nail porch as shown.

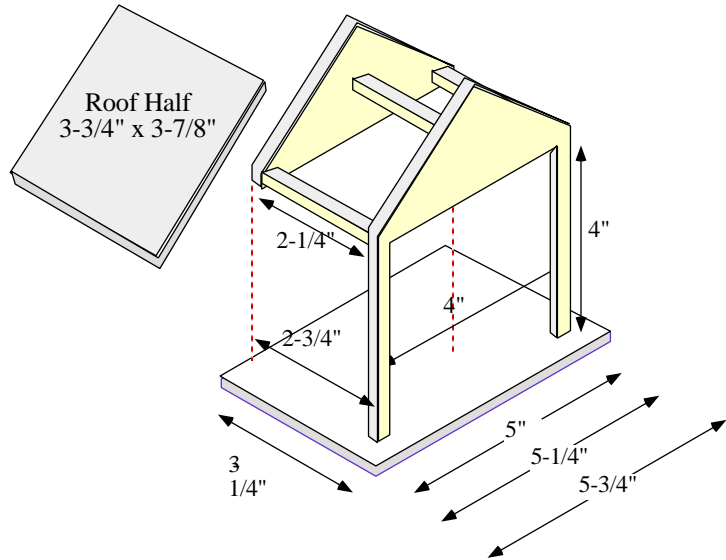

Base is added to the foundation
 Length According to Placement on wall
 Any wall porch centered 3-1/4" x 5"
 End Wall - porch to the side 3-1/4" x 5-1/4"
 Side Wall - porch to the side 3-1/4" x 5-3/4"

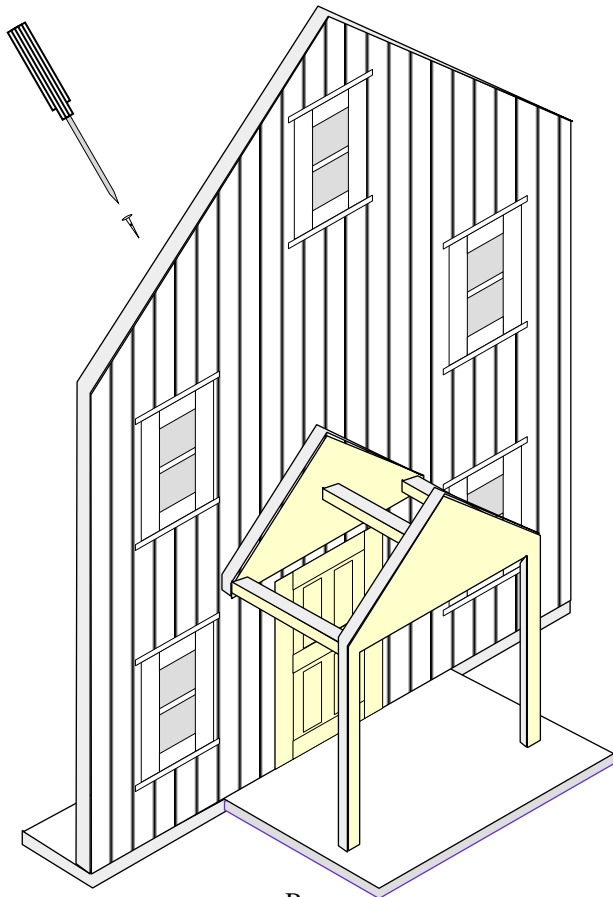

B
 Glue the back of the porch frame. From the inside wall, put a small screw through the pilot hole into the porch frame to secure porch.

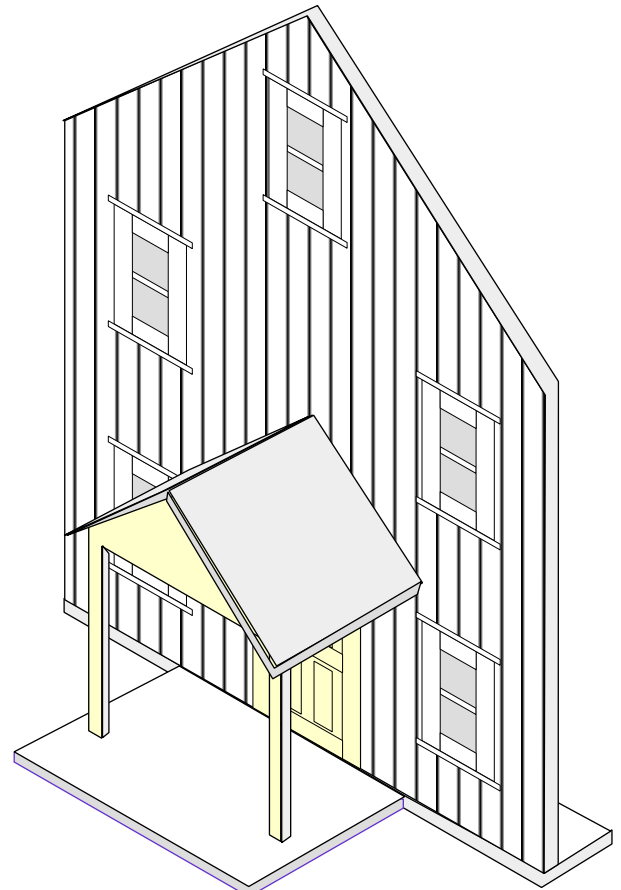

C
 Carefully center and glue roof onto porch as shown.

Cut from 1/4" Plywood

1 Story End Walls

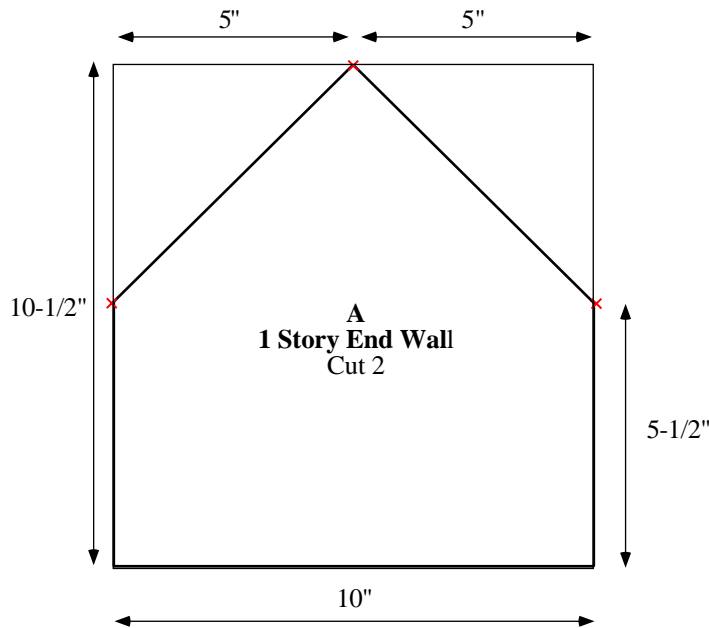

End Wall

- Begin with a rectangle 10-1/2" High x 10" Wide
- Measure and mark the top center (5" from each side)
- Measure and mark 15-1/2" up from the bottom on both sides
- With ruler, draw your lines between the x's, forming the roofline
- Cut out two End Walls

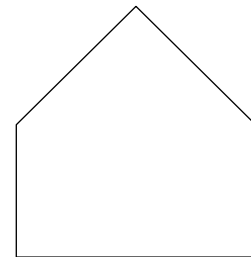

Cut-out End Wall
will look like this

1 Story Side Walls

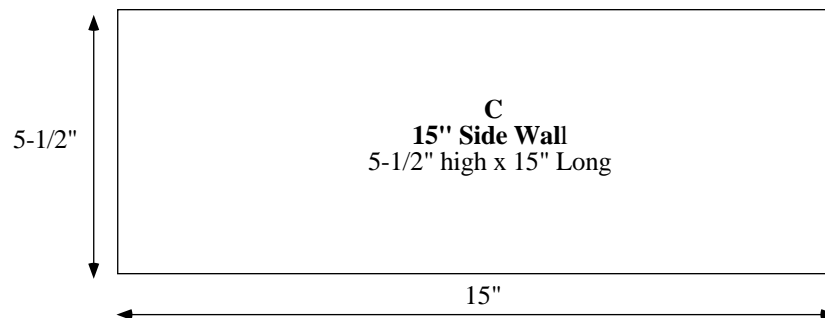

Cut from 1/4" Plywood

2 Story End Walls

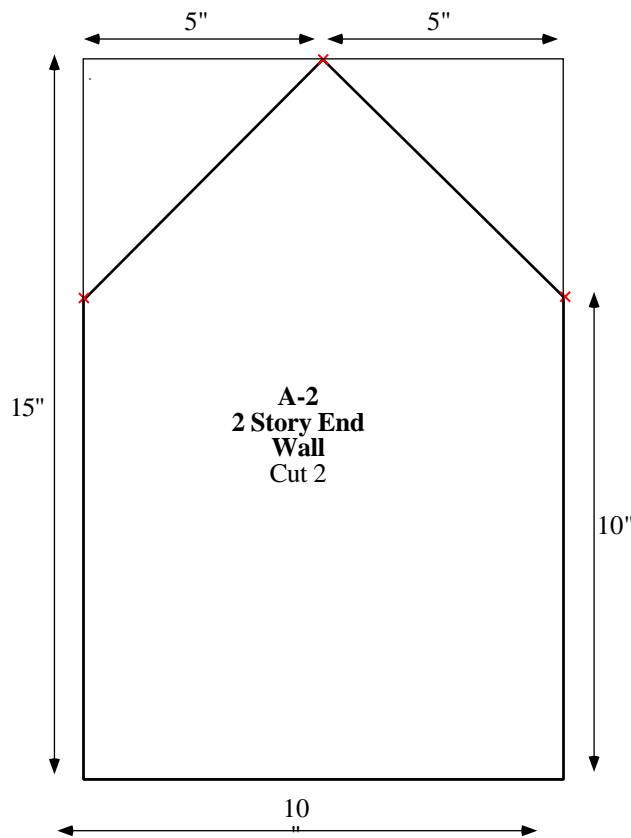

End Wall

- Begin with a rectangle 15" High x 10" Wide
- Measure and mark the top center (5" from each side)
- Measure and mark 10" up from the bottom on both sides
- With ruler, draw your lines between the x's, forming the roofline.
- Cut out two End Walls

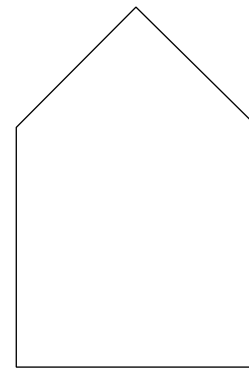

Cut-out End Wall will look like this

2 Story Side Walls

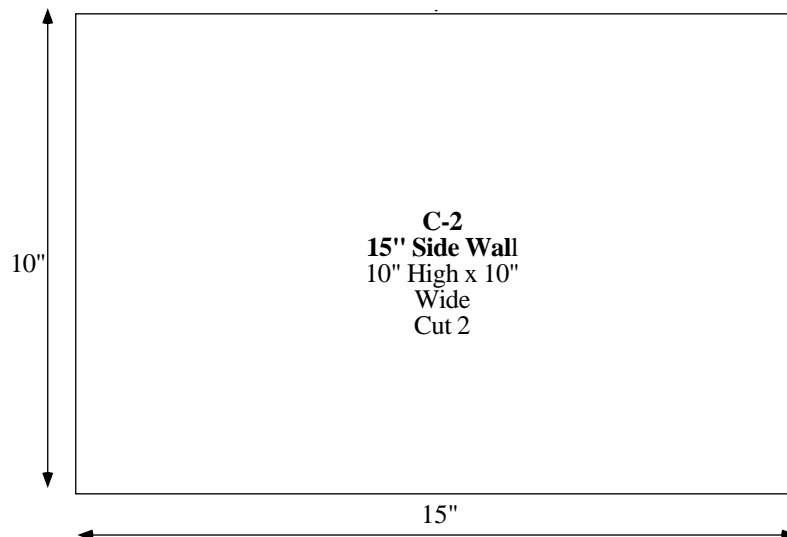

Cut from 1/4" Plywood

Roofs for 1 or 2 Story Houses
15" Sidewalls - Choose 2 Halves, as required

M Miter @ 45°
 ***See Before You Begin - Hints and Tips
 Two Ways to Assemble 45° Roofs
 For non-mitered roof, add 1/4" to height for one roof half only

Plain Roof Halves

For 1 or 2 Story Side Walls
 with no ground type chimney

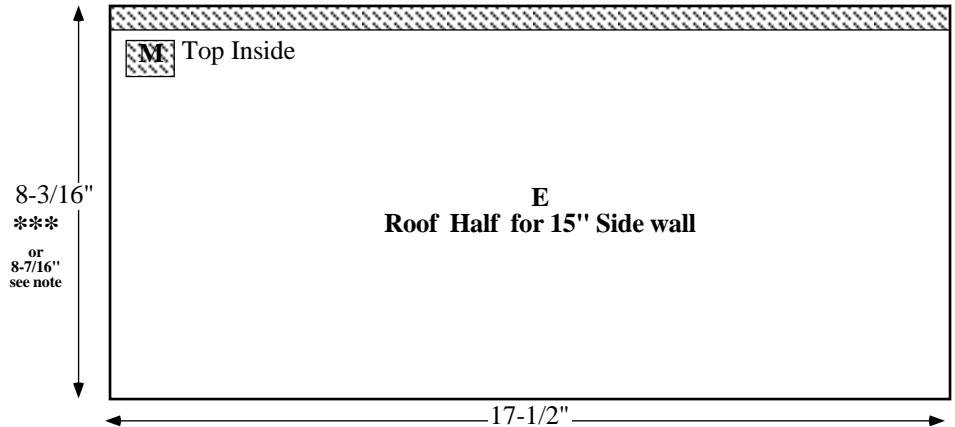

For 1 or 2 Story Side Wall
 with offset Ground Chimney

Make the notch 2-1/2" wide and 1/2" deep
 You may have to trim a bit more when
 actually fitting the chimney in place. .

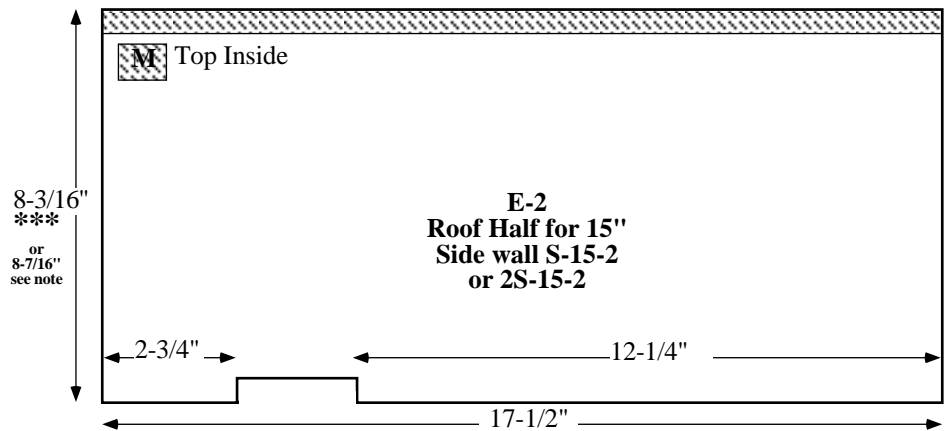

For 1 or 2 Story Side Wall
 with centered Ground Chimney

Make the notch 2-1/2" wide and 1/2" deep
 You may have to trim a bit more when
 actually fitting the chimney in place. .

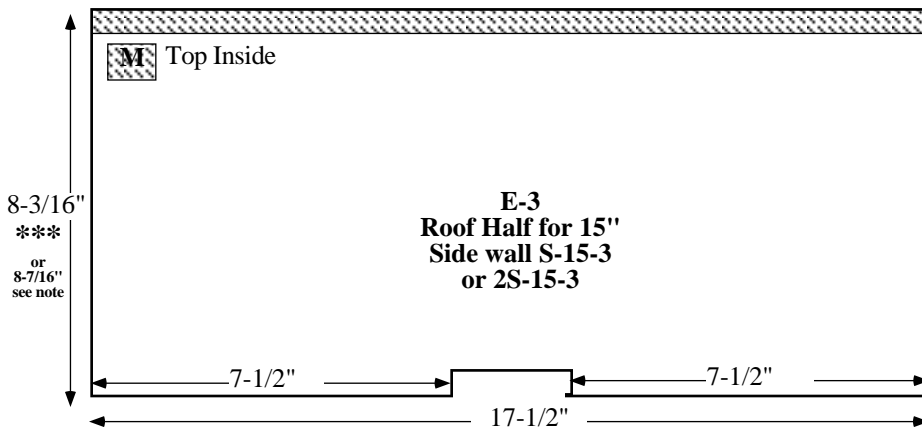

Cut from 1/4" Plywood

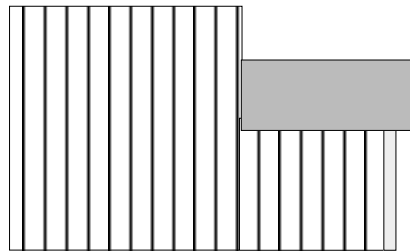

Room Addition
 Use with 1 or 2 Story End Wall
 or 2 Story Side Wall

Room Additions
 Side Walls and End Wall

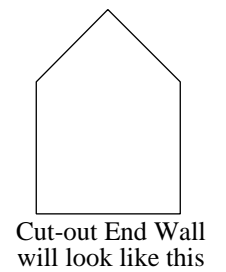
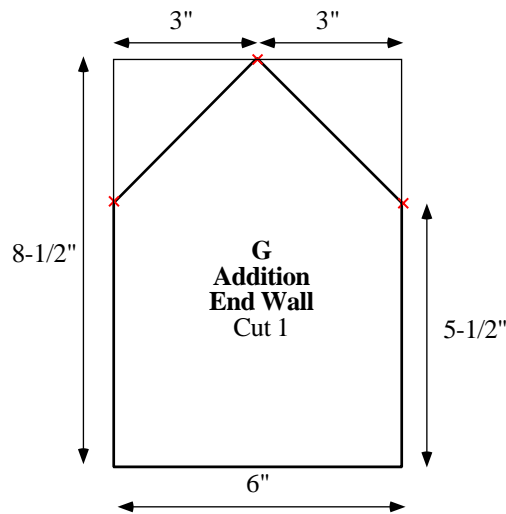
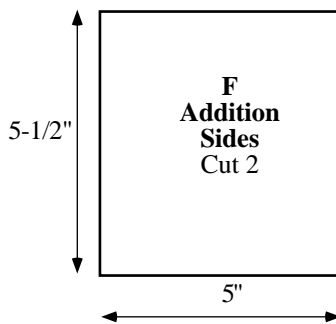

End Wall

- Begin with a rectangle 8-1/2" High x 6" Wide
- Measure and mark the top center (3" from each side)
- Measure and mark 5-1/2" up from the bottom on both sides
- With ruler, draw your lines between the x's, forming the roofline.
- Cut out 1 End Wall

Addition Roof

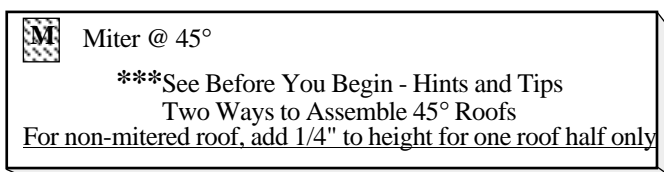

*** 5-1/4"
 or
 5-1/2"
 see note

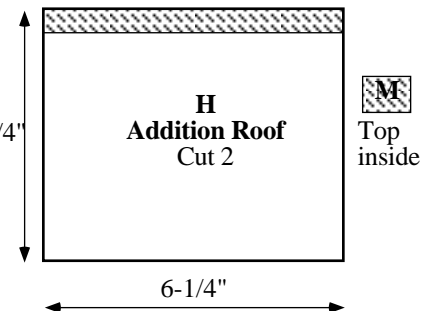

The Foundations INFORMATION FOR ADJUSTMENTS IF REQUIRED

All Additions (chimney, porch, and room) will fit on a 2 Story House. Because of the roof angle, a Room Addition or a Porch will not fit on a 1 Story House Side Wall. They will fit on an End Wall.

You can leave off any addition to the foundations if you wish to use a basic wall instead of one with an addition. Use the appropriate measurements which do not include the dimensions for the addition.

The Sample to the right is of Foundation 2, as shown in the patterns. The Samples below are adjustments to Foundation #2. Use the same technique with any of the foundations.

2
 With All
 Dimensions
 Shown

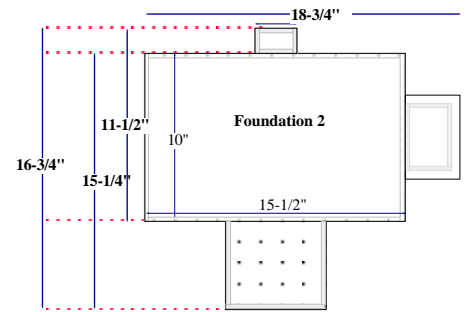

<p># 2 With Chimney, Porch and Room Addition 2 Story only 16-3/4" x 18-3/4"</p>	<p># 2 With Chimney and Room Addition 2 Story only 16-3/4" x 15-1/2"</p>	<p># 2 With Porch and Room Addition 2 Story only 15-1/4" x 18-3/4"</p>
<p># 2 With Chimney and Porch on End Wall 1 Story or 2 Story 11-1/2" x 18-3/4"</p>	<p># 2 With Chimney 1 Story or 2 Story 11-1/2" x 15-1/2"</p>	<p># 2 With Porch on End Wall Use with 1 Story or 2 Story 10" x 18-3/4"</p>

Foundation Patterns

Note:
 Side Walls are assembled
 inside of the End Walls.
 Illustration shows wall placement
 inside the foundation.

1 Basic Foundation

Foundation # 1 for 1 Story or 2 Story Houses which do not have any additions.

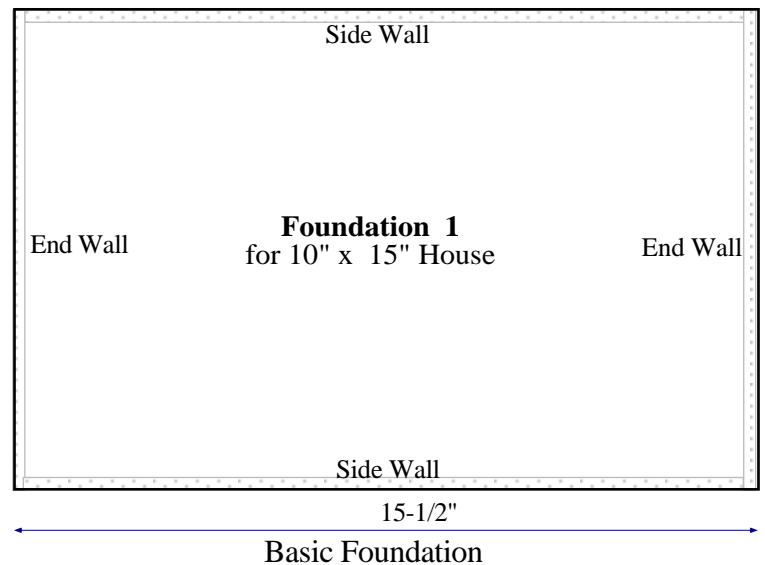

2

For 1 Story House
 begin with rectangle
 11-1/2" x 18-3/4"
 (Leave off
 Room Addition
 Foundation)

For 2 Story House
 begin with rectangle
 16-3/4" x 18-3/4"

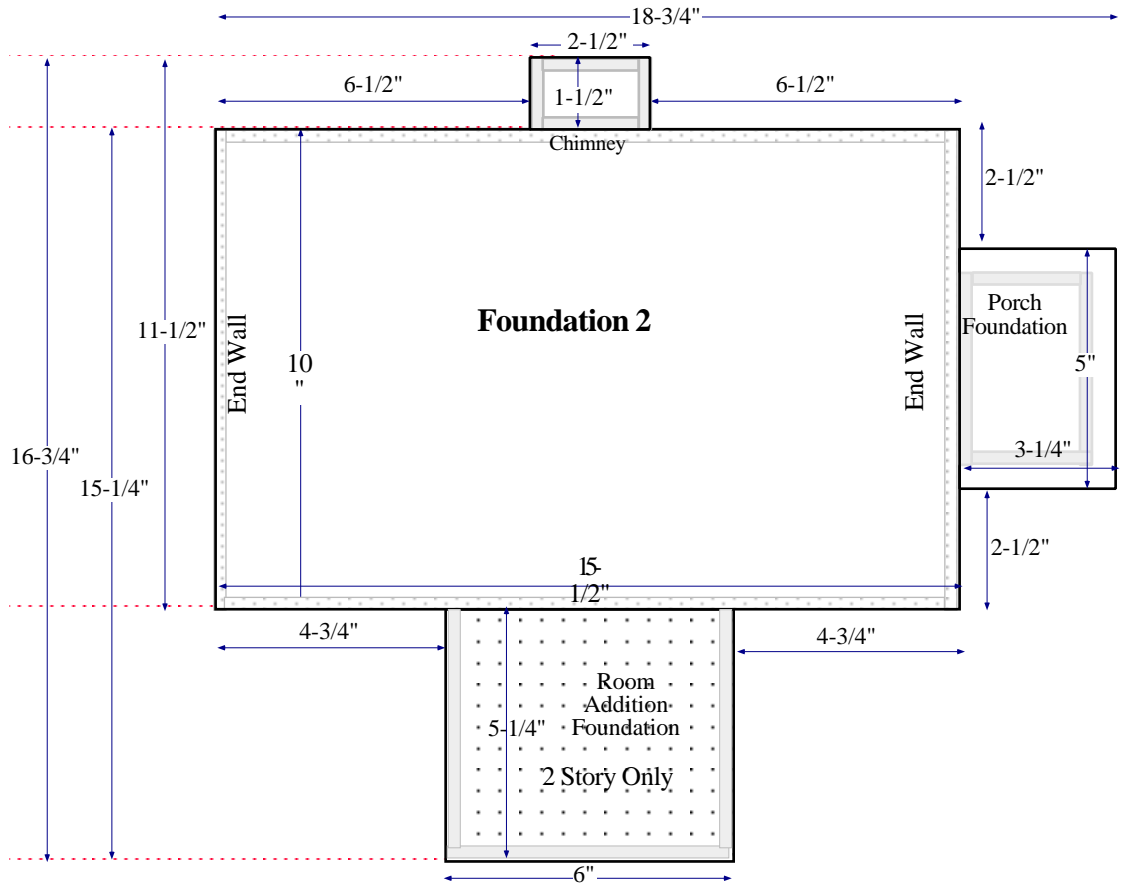

3

For 1 Story House
 begin with rectangle
 11-1/2" x 18-3/4"
 (Leave off
 Room Addition
 Foundation)

For 2 Story House
 begin with rectangle
 16-3/4" x 18-3/4"

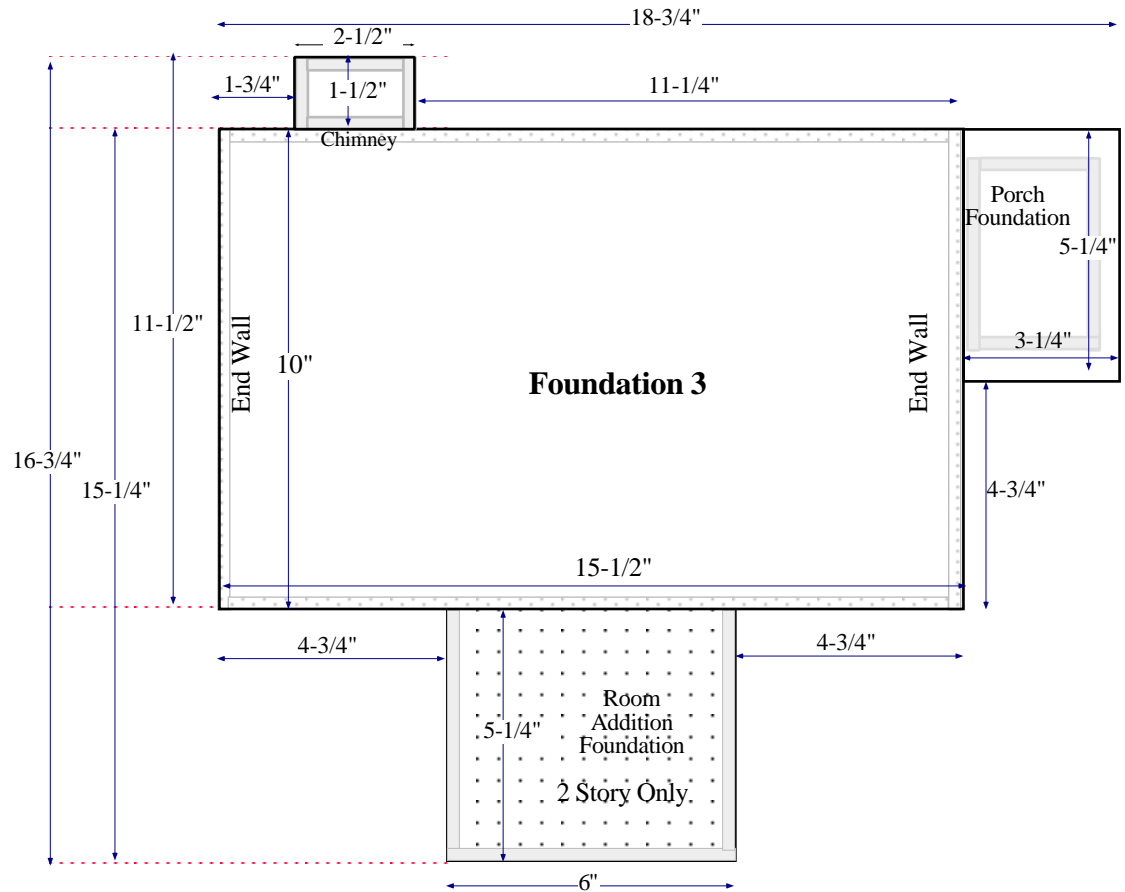

4

For 1 Story House
 begin with rectangle
 10" x 20-3/4"
 (Leave off
 Porch Foundation)

For 2 Story House
 begin with rectangle
 13-1/4" x 20-3/4"

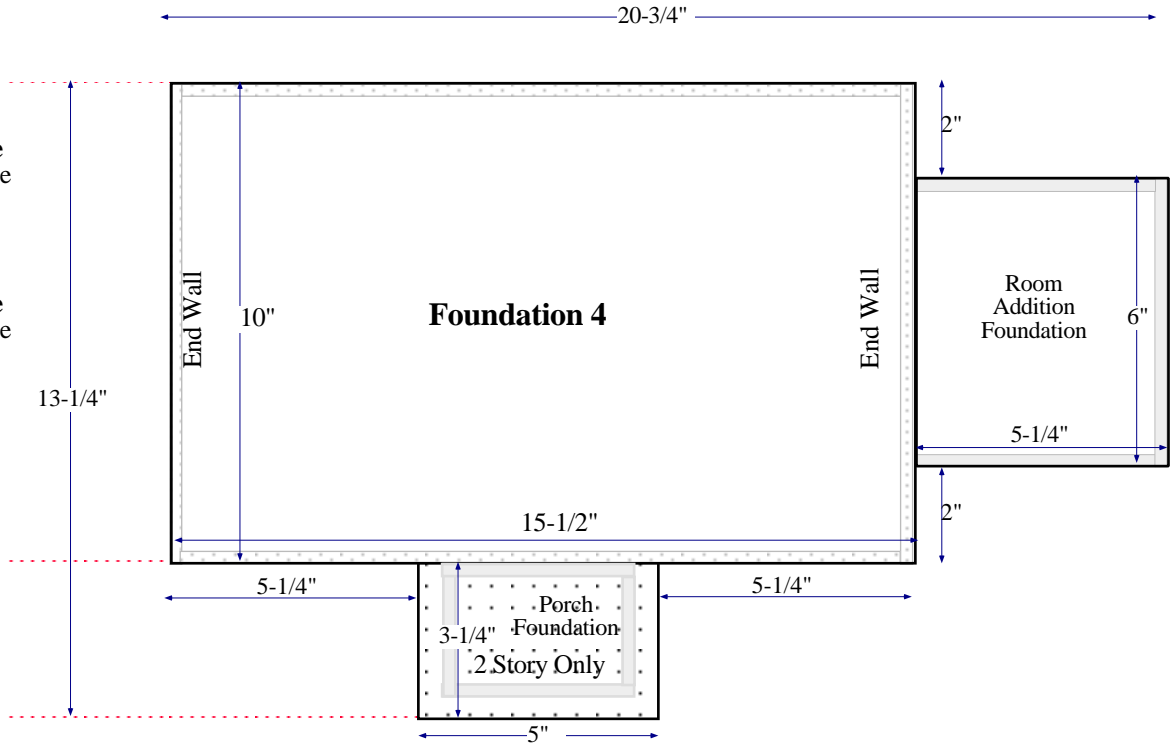

5

For 1 Story House
 begin with rectangle
 11-1/2" x 20-3/4"
 (Leave off
 Porch Foundation)

For 2 Story House
 begin with rectangle
 14-3/4" x 20-3/4"

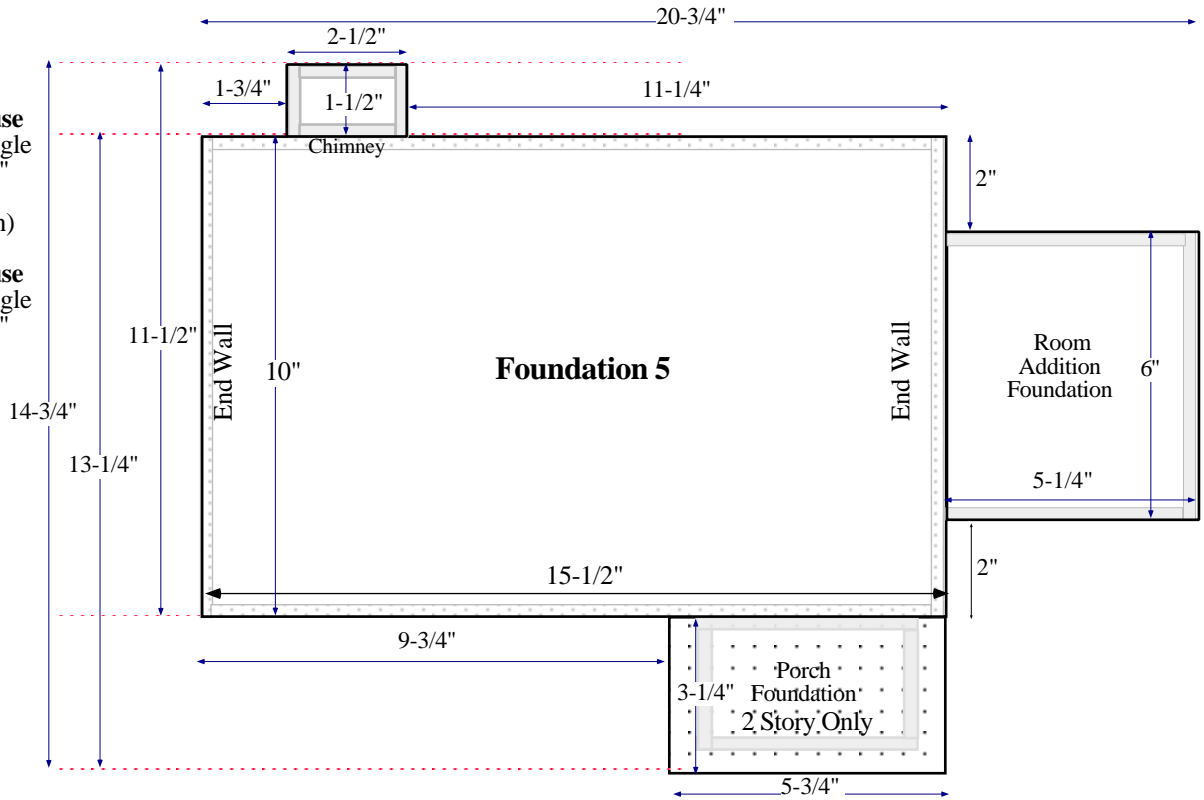

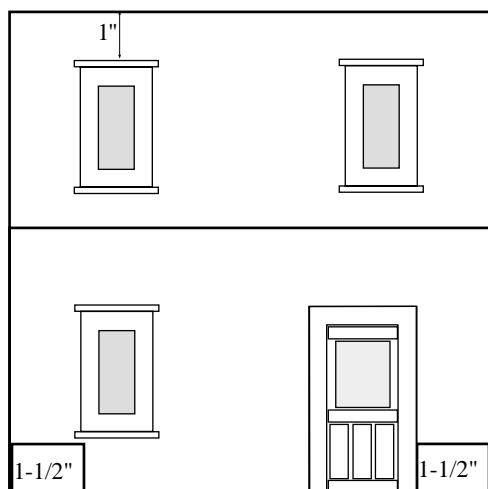
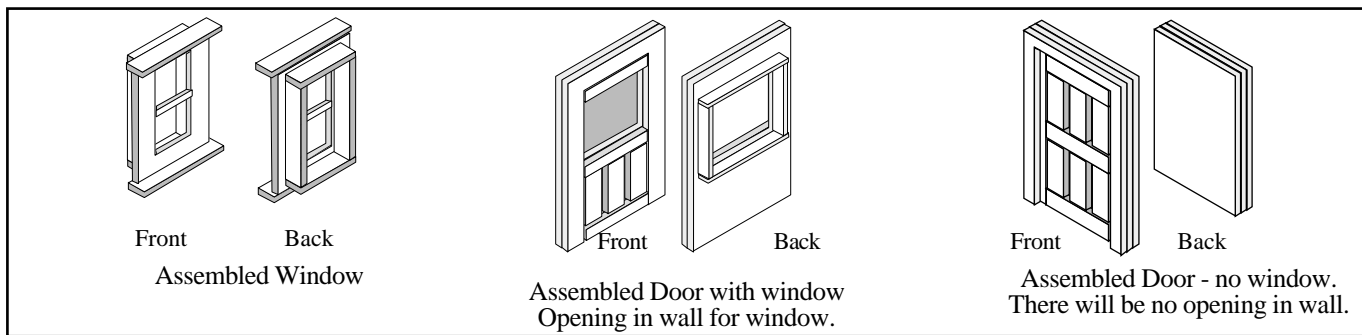

Decide where you want to place door and windows on the cut-out wall

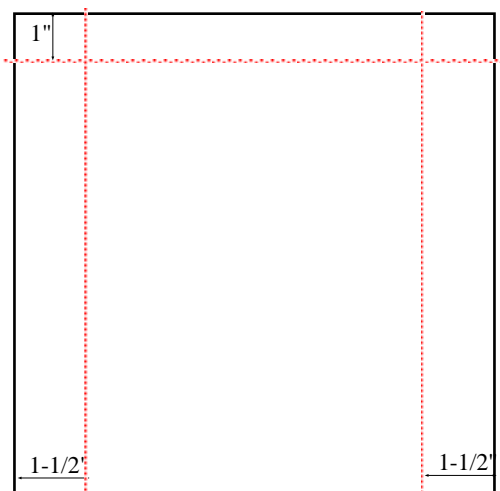

With pencil and ruler, lightly draw guide lines on the wall.

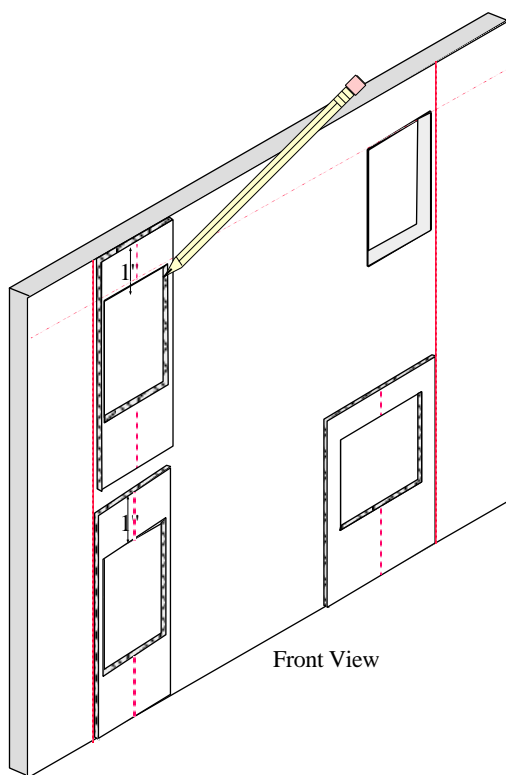

Template for Window Opening in Wall

Important: After you cut your template check that your sizes and openings are accurate according to the dimensions noted. Use a ruler to check. You can take a finished window or door and make sure that it physically fits into the template opening.

Using your side guide lines, place the template as follows.

- Ground floor:**
Bottom of template will be on bottom of wall
- 2nd floor**
Top of template will be on top of wall

Using template and pencil, mark the window opening on the building. Cut out opening on building. The opening is now ready for the finished door or window.

Note: Doors and windows should be painted or stained before you actually insert and secure them into the building. Before gluing windows, check to see that they will easily fit the wall openings. Trim openings if necessary.

Walls should be assembled and painted prior to installing doors and windows.
 See page 44

Place some wood glue on the flat backs of the finished window and door with window. (around the frame) This will adhere to the front of the wall.

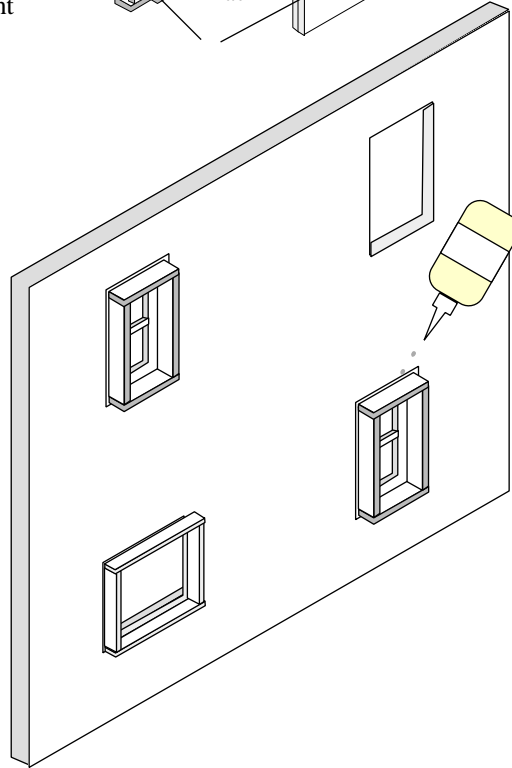
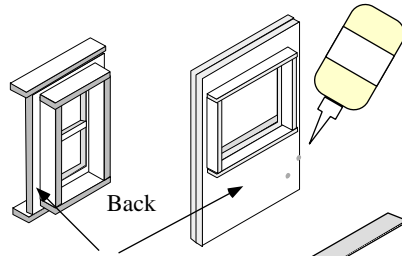

Insert the glued window or door with window into the appropriate wall opening. Look at the front side and using a level, make sure the window is straight. Run a bead of wood glue around the window brace. Allow the glue to dry.

Back View

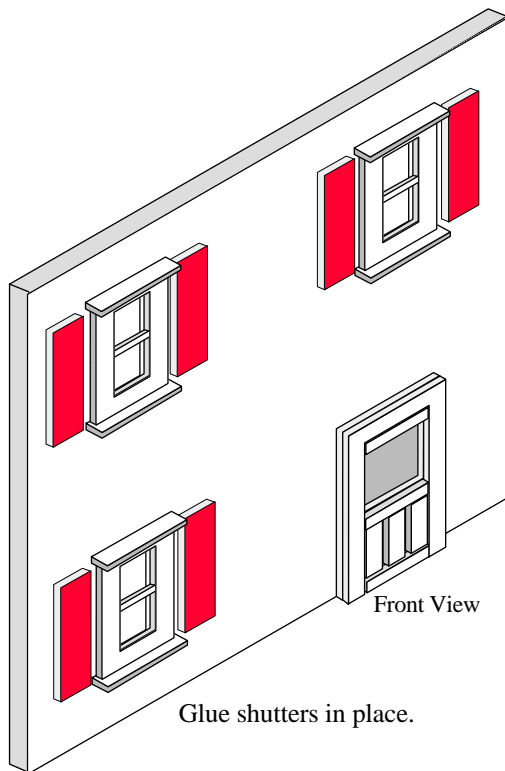

Glue shutters in place.

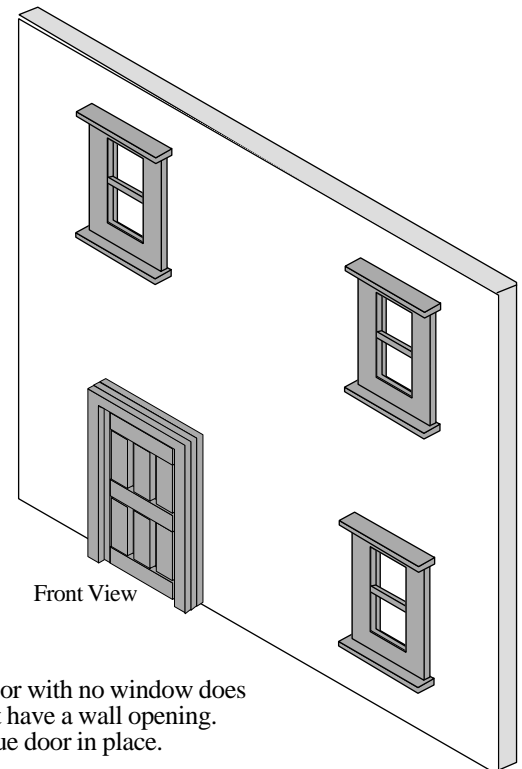

Door with no window does not have a wall opening.
 Glue door in place.

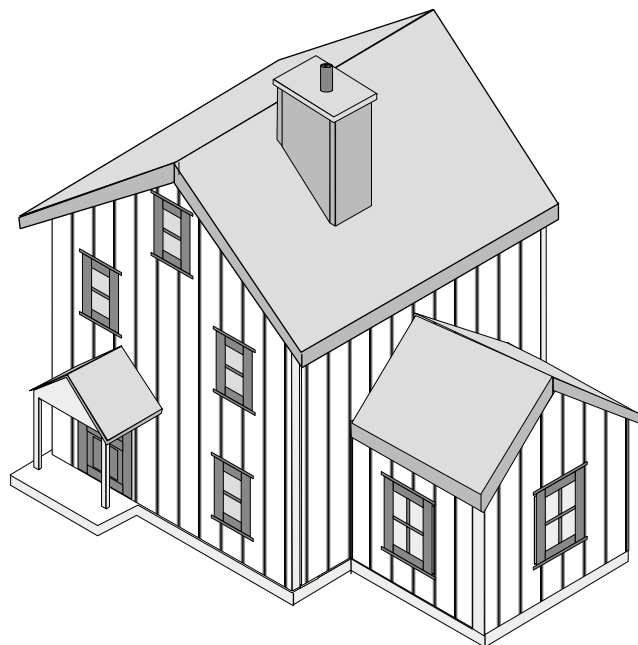
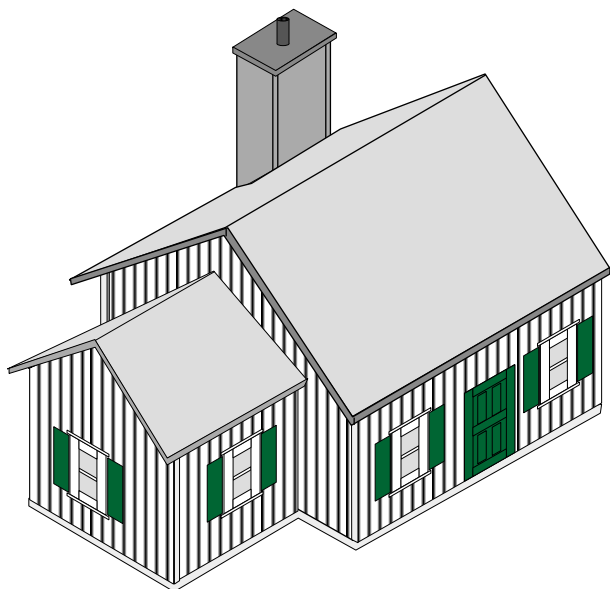

The following illustrations will show assembly of two 45° roof houses; a one story and a two story. The length of the sidewalls doesn't matter. Instructions apply to both houses unless noted otherwise. The specific instructions will be in boxes.

1 Story House
with room addition,
and ground
chimney

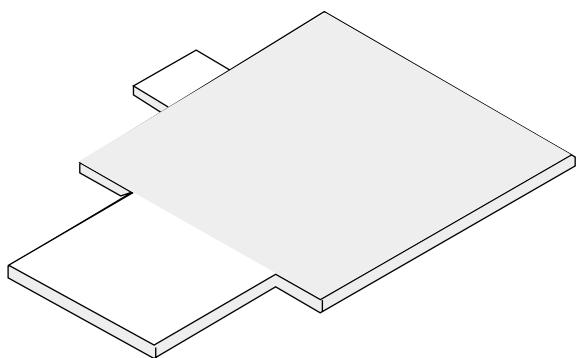

2 Story House
with room addition,
porch and rooftop
chimney

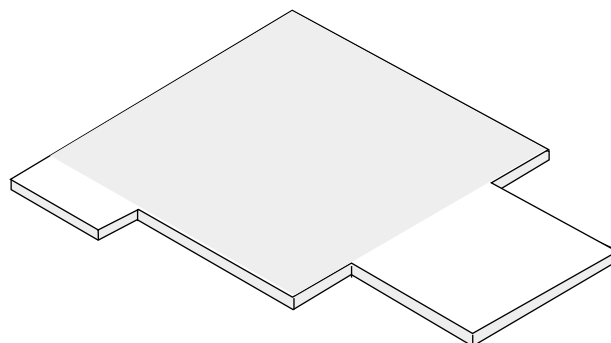

- 1.** The Foundation
Using your Basic Foundation plans and any additions you have decided upon, cut out the Total House Foundation. (For illustration only, the Basic Foundation area is shaded.)

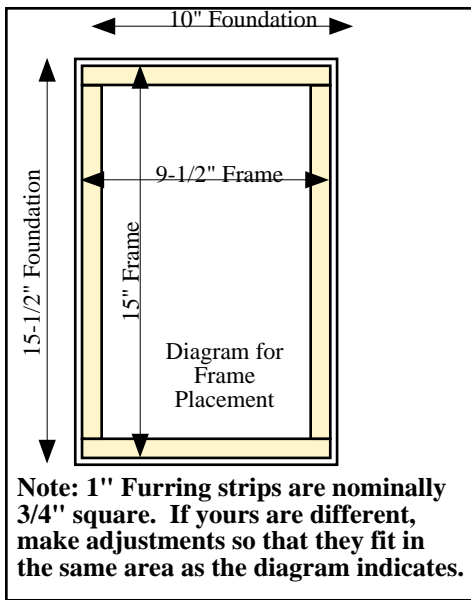

Reminder:
 Do not cut openings in bottom frame if using Garden Town or other non-opening doors

2. Bottom Frame
 Refer to the Diagram for Frame Placement

- With ruler and pencil measure and mark 1/4" inside the foundation. (For depth of the walls)

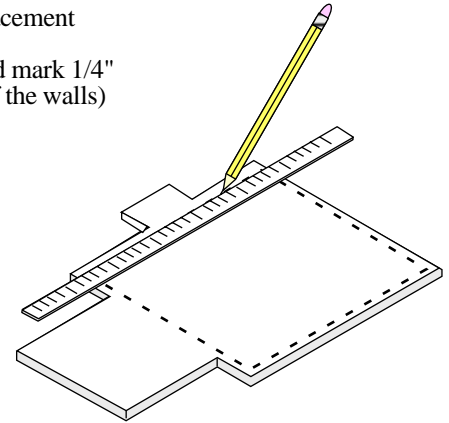

3.

- Lay the Frame pieces out on the foundation and make sure they fit inside the 1/4" lines.
- If you are using opening doors, cut out appropriate spaces wherever you wish to place the doors.
- Glue bottom frame in place one piece at a time. Immediately go to step 3A.

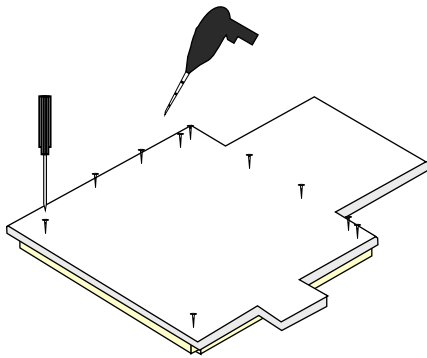
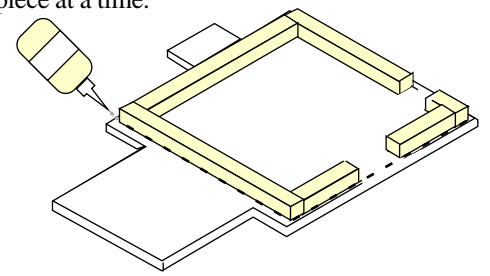

3A.

- To strengthen the assembly:
- Flip the foundation assembly over to the back.
 - Drill small pilot holes through the foundation and the frame pieces. Insert small flat head wood screws to hold the frame in place.
- Be sure to maintain right angles at corners*

4. Top Frame

- Lay the pieces out on a flat surface, using continuous pieces. (No openings for doors.) The overall dimensions will be the same as the bottom frame
- Glue and nail or staple the top frame together, again maintaining corner angles.

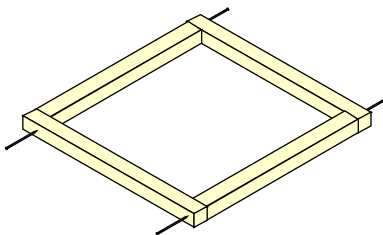

Check Alignment of Horizontal Braces

- Position the Top Brace over the Bottom Brace to ensure that the two pieces are in alignment.
- The two braces should line up vertically and be the same dimensions on all sides. If they don't line up, double check your work and make adjustments. (Favorite thing to do)

- Then lay the Top Brace aside.

(1 story house illustrated)

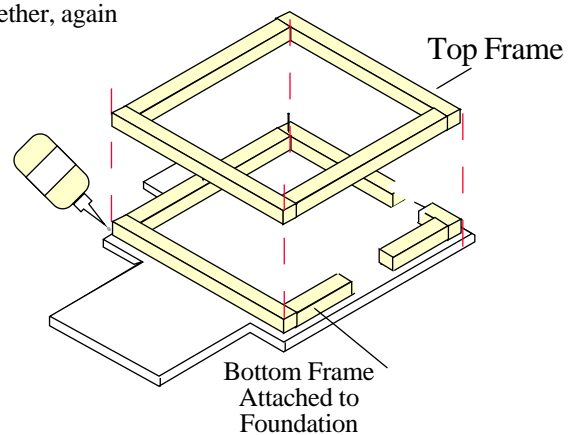

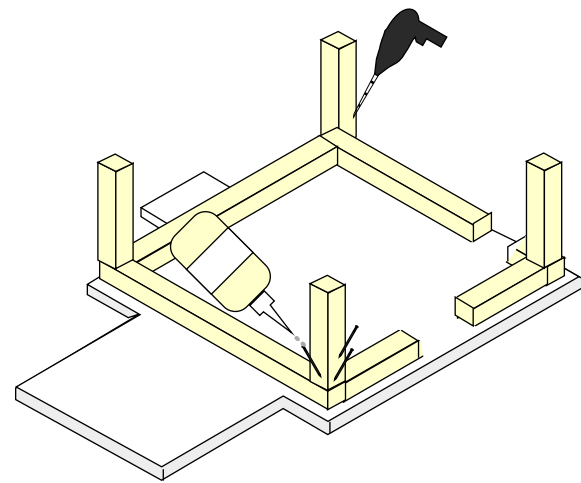

1 Story

5. Vertical Studs
 Each wall needs a vertical stud on each end. Lightly glue and nail or staple a vertical stud at each corner for the walls to be attached to.

Note: Nailing the studs in place will be much easier if you begin with drilling a small pilot hole for the nail.

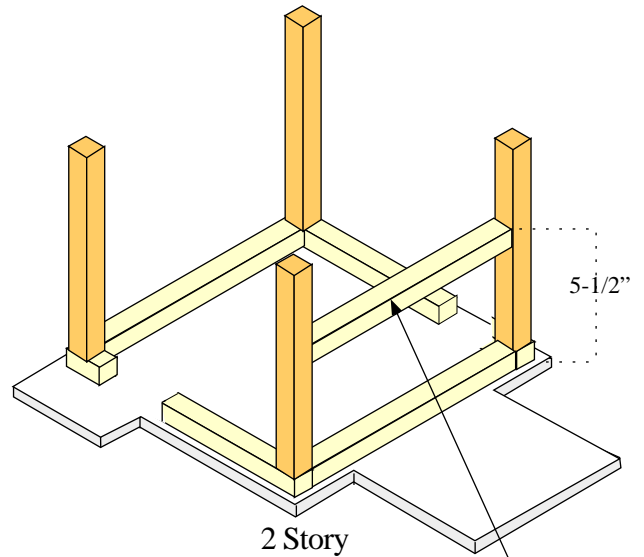

2 Story

2 Story only
 If you are building a two story house with a room addition, you can add an additional horizontal brace to your frame. Cut it the same length as the upper and lower braces on that side.

Measure and place the top of the brace at 5-1/2" above the foundation.

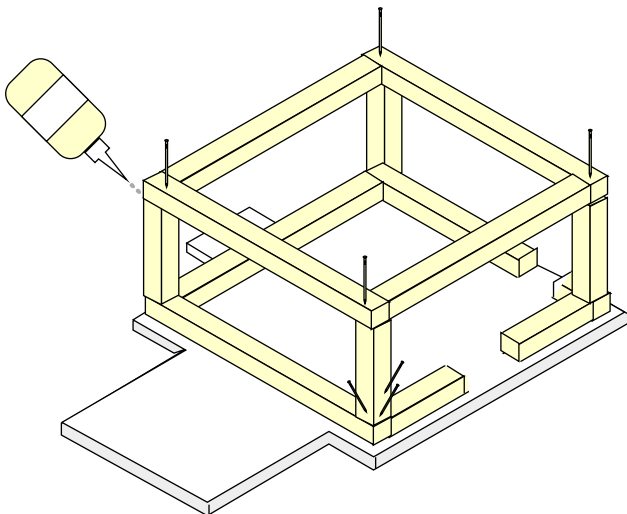

1 Story

6. Lightly glue the tops of the vertical studs. Place the assembled top brace on top of the vertical studs, matching up with the bottom brace. Nail or staple the top brace to all vertical studs.

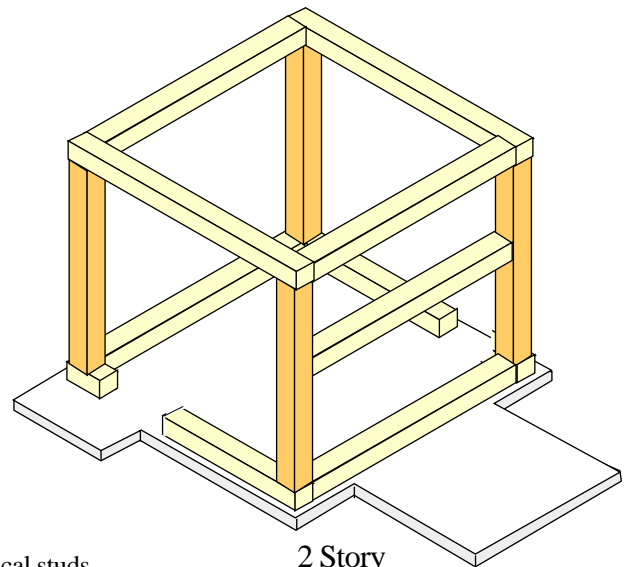

2 Story

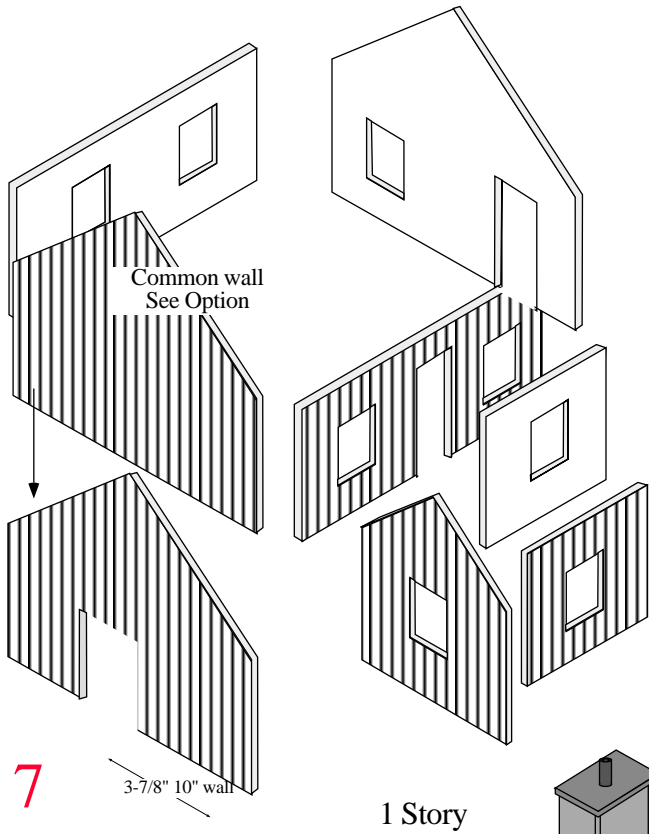

1 Story

Common Wall Option
 For adding inside lights to your house:
 On common wall which the addition will attach to -
 cut out an inside doorway to correspond with your room addition. Center the doorway.
 Make the doorway 2-1/4" w x 4" h.
 This opening will not be fitted with a door but will allow the light to flow through the entire house. You won't have to cut into the bottom frame for this wall.

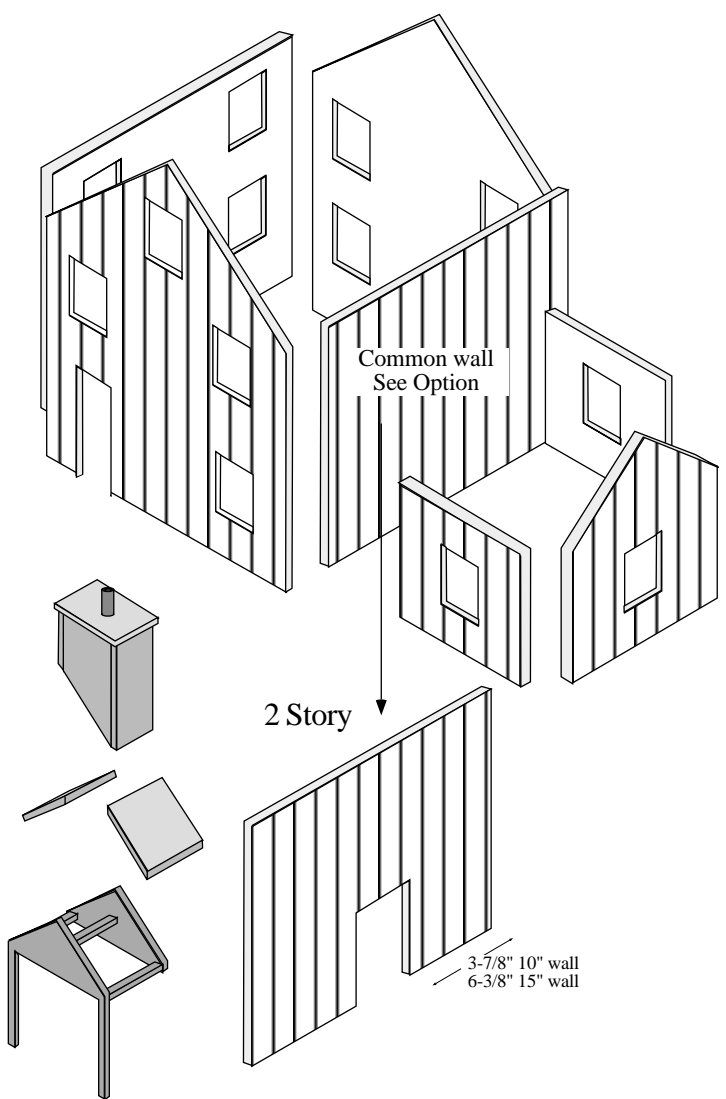

2 Story

8. Install the common wall
 Center the wall.
 Glue and nail or staple
 the wall firmly to the
 frame.

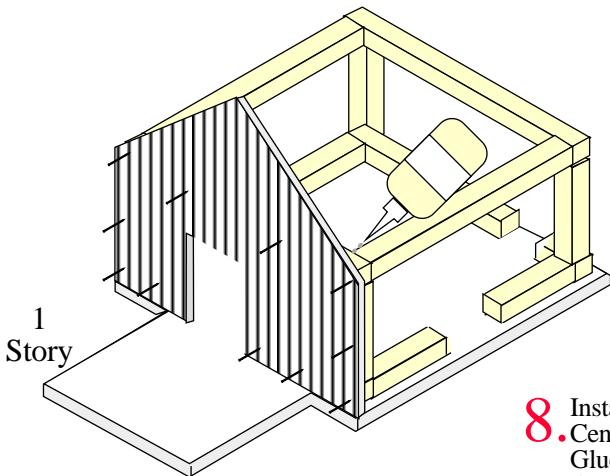

1 Story

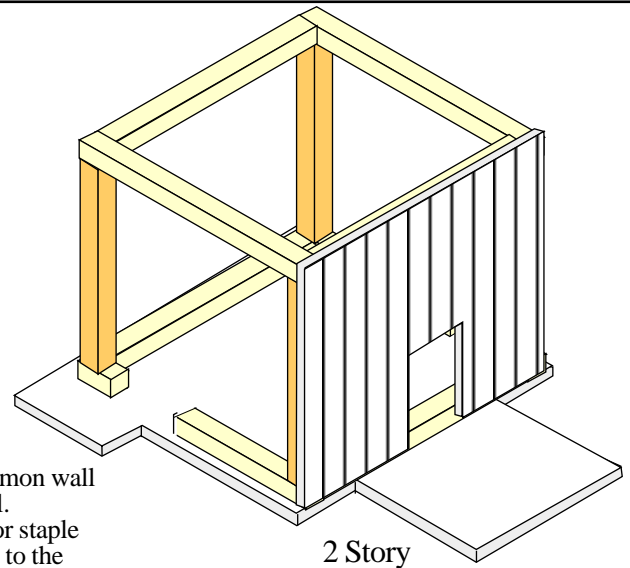

2 Story

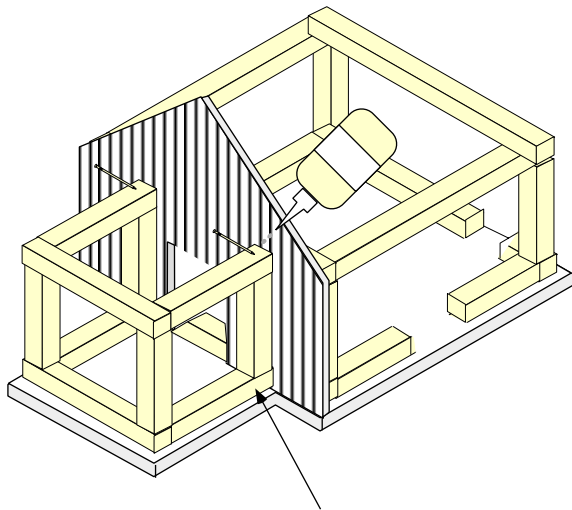

1 Story

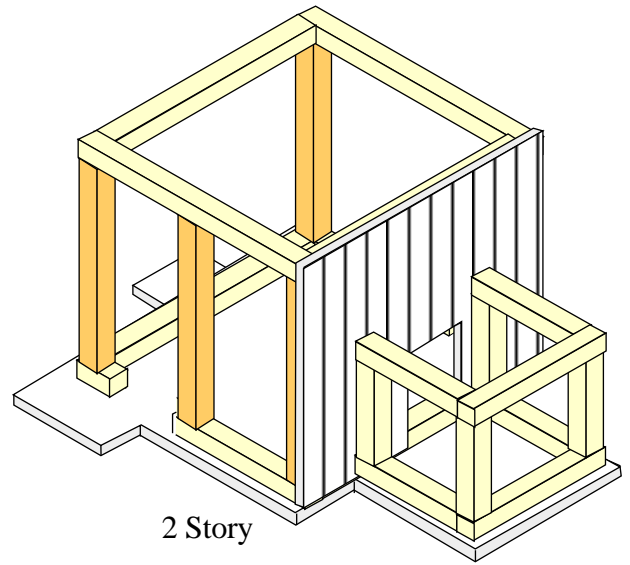

2 Story

9. Using the same rules as you used for the house frame, build up the room addition frame. (Attach the bottom parts to the foundation. Then the vertical braces and top frame.)
Glue and nail the frame top to the common wall and top house brace.

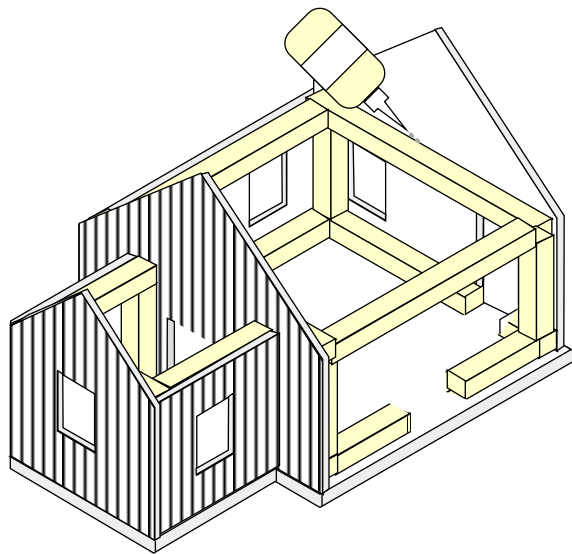

1 Story

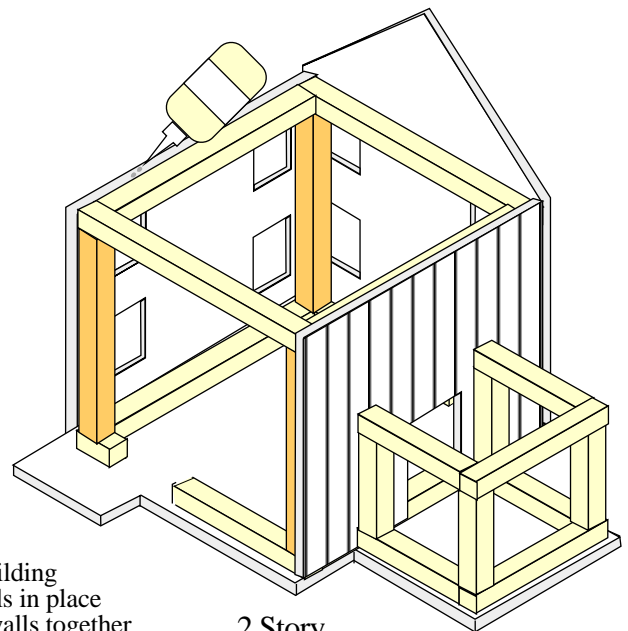

2 Story

10. Start at one end of building and nail or staple walls in place to the frame. Work walls together in a clockwise or counterclockwise direction. Direction doesn't matter. Just fit the adjacent walls and keep going in the same direction.

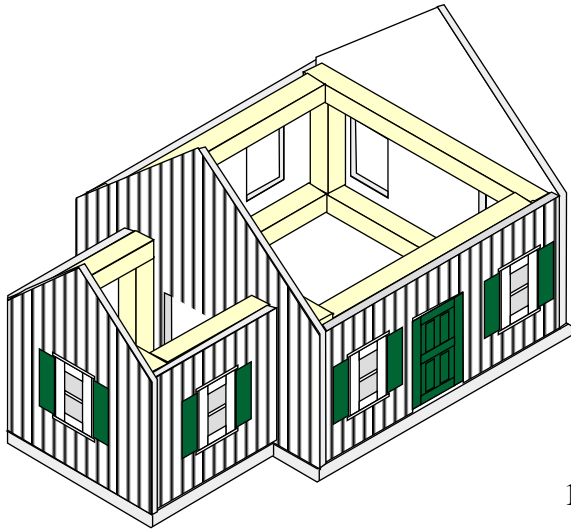

1 Story

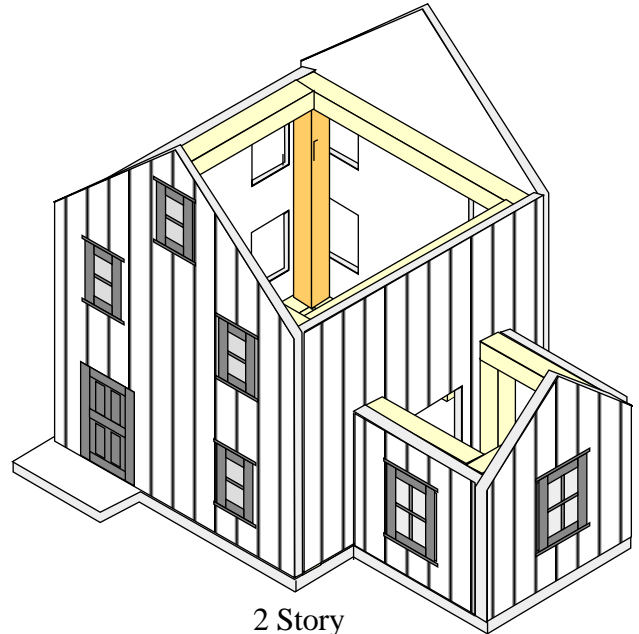

2 Story

11.

Continue adding walls until all walls are in place. Always nail or staple into the frame. Check that each wall is sturdily attached and that there are no "floppy" walls.

Install your doors and windows before adding the porch or the roof.
See Assembly - Walls

Note:

1 Story house can not have a porch on the side wall because the house roofline is too low. If you install a porch on the end wall, use one of the foundations with porch floor. Attach in the same manner as the two story illustration.

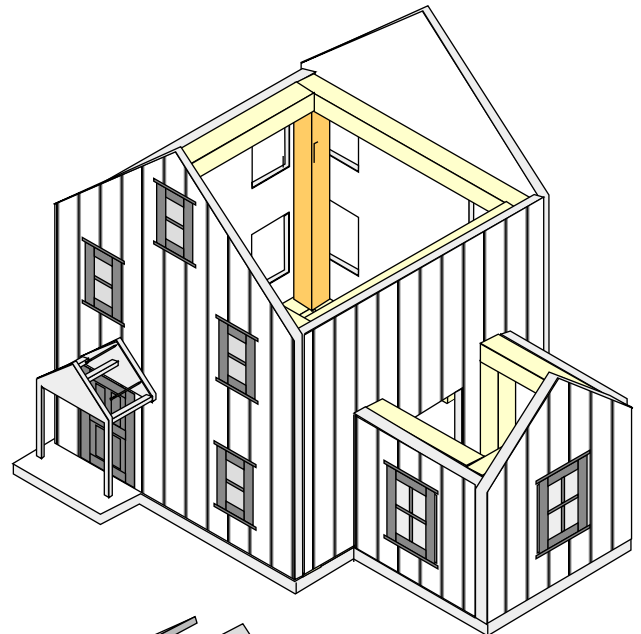

12.

Position and attach the porch frame to the house wall. Be sure to secure the posts to the foundation. When dry, carefully center and attach the porch roof.

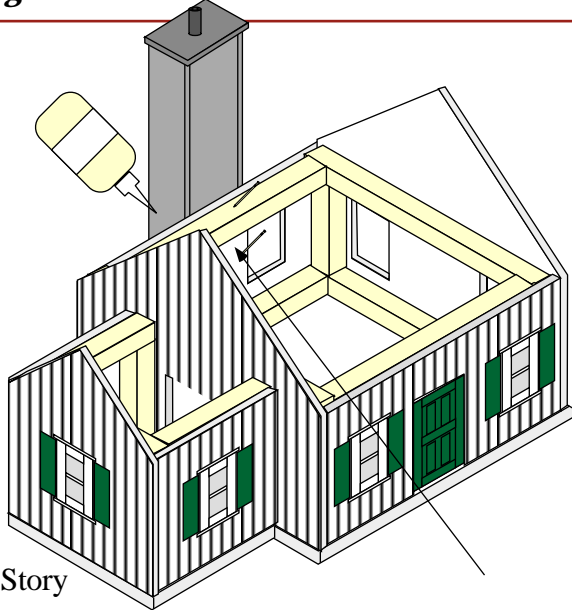

1 Story

- 13.** Ground Chimney shown on 1 Story House
 Glue the assembled ground chimney to the chimney foundation and the side of the house. Secure with nails or staples from the inside of the wall.

Note: If you are adding lights to your house, use screws to attach the roof. This will enable you to have access to the wiring.

Roof half for ground chimney is notched to fit around chimney.

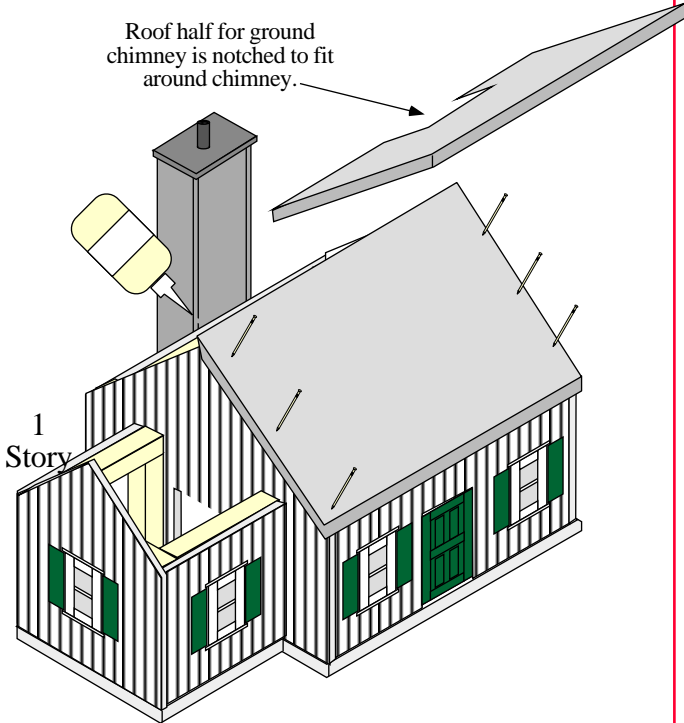

1 Story

- 14.** •Run a bead of glue around the exposed wood that the roof will sit on as well as the inside tops of the roof halves where they join.
 •One at a time, carefully center one roof half in place. Glue and nail or staple to the building, nailing into the frame. Match up the second half and secure in the same manner, making certain that the roof tops are lined up.

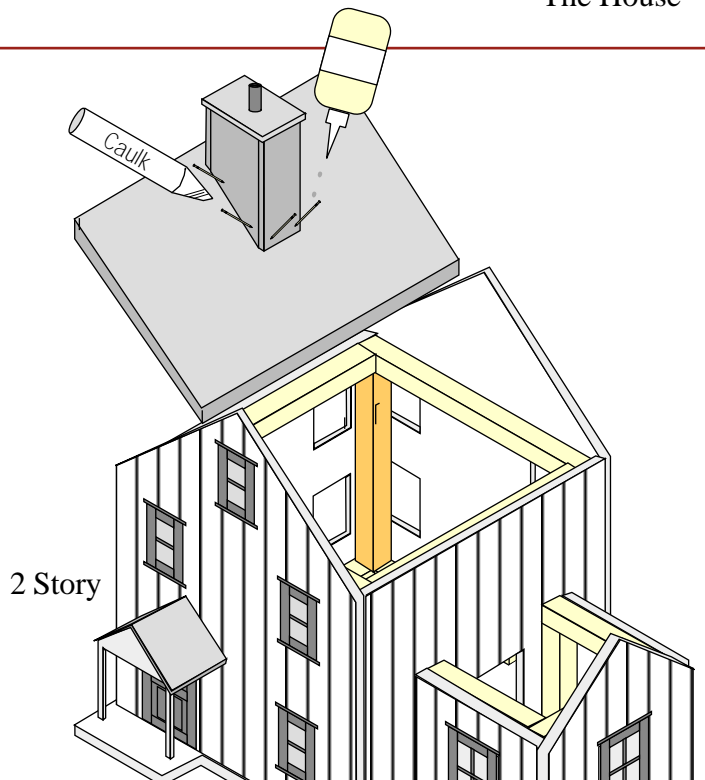

2 Story

- 13.** Rooftop Chimney shown on 2 Story House
 Reminder: Don't place the chimney directly above a door or window opening. You can attach the assembled chimney to the roof before or after you attach the roof to the house. Run a bead of glue on the bottom side of the chimney frame and attach with small nails or staples. You may want to caulk around the outside bottom of the chimney to ensure a good seal.

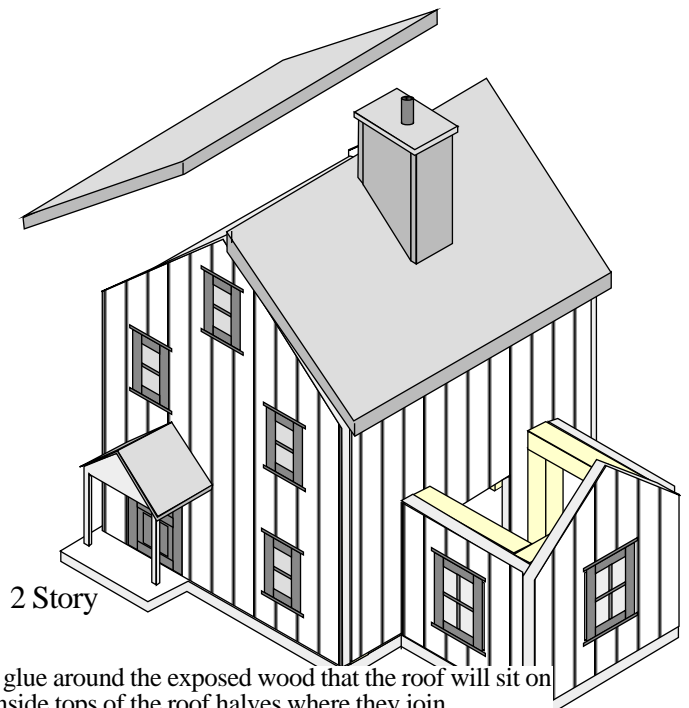

2 Story

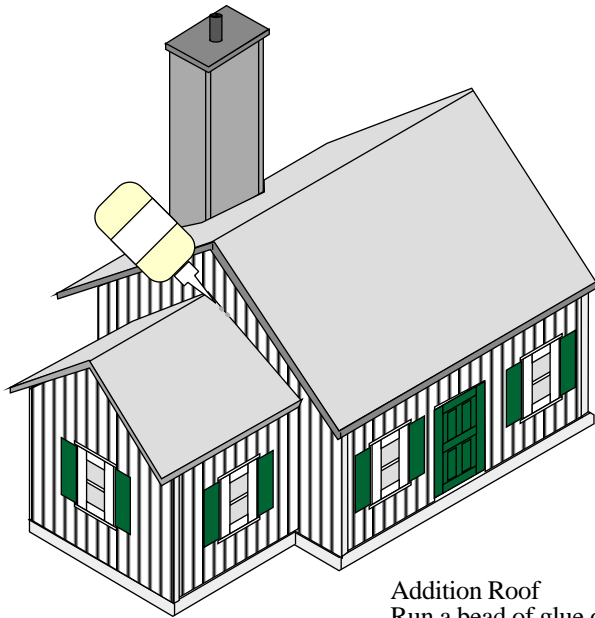

1 Story

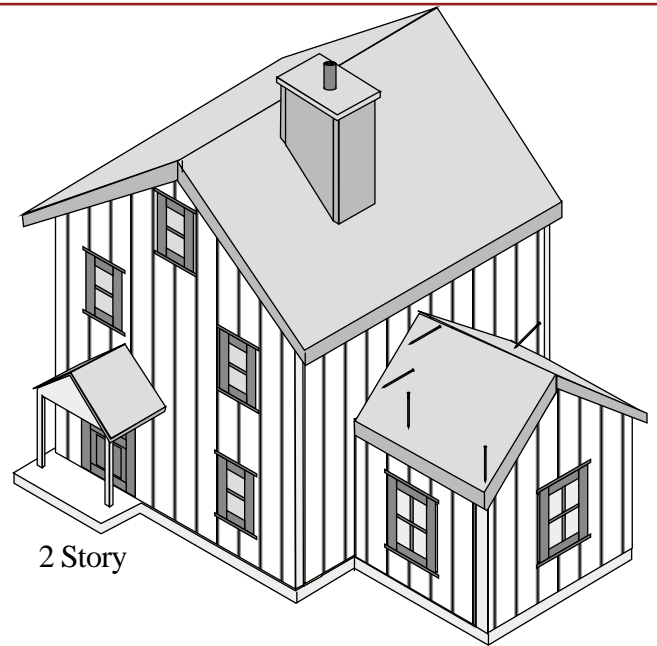

2 Story

15.

Addition Roof

Run a bead of glue on all exposed areas of the addition where roof will touch. Also glue the inside top halves of the roof where they will join and the ends which will fit against the house.

Carefully place the one half of the addition roof onto the addition .

Secure with glue. Place the other half of the roof.

Line up the roof lines at the top and overhangs. Make sure there are no gaps between the two roofs. You may have to do a minimal amount of trimming at the overhang to get a smooth finish.

Nail or staple the roof halves in place.

Hint:

If there is a small gap just run some caulking down the "seams".

Then if you paint the roof, paint over the caulking when dry.

If you add wooden or other type shingles, the shingles will cover the caulking.

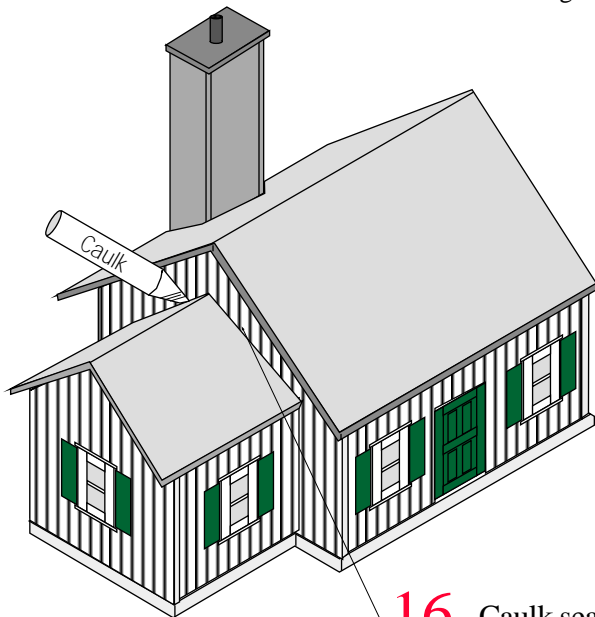

1 Story

16. Caulk seams if needed.

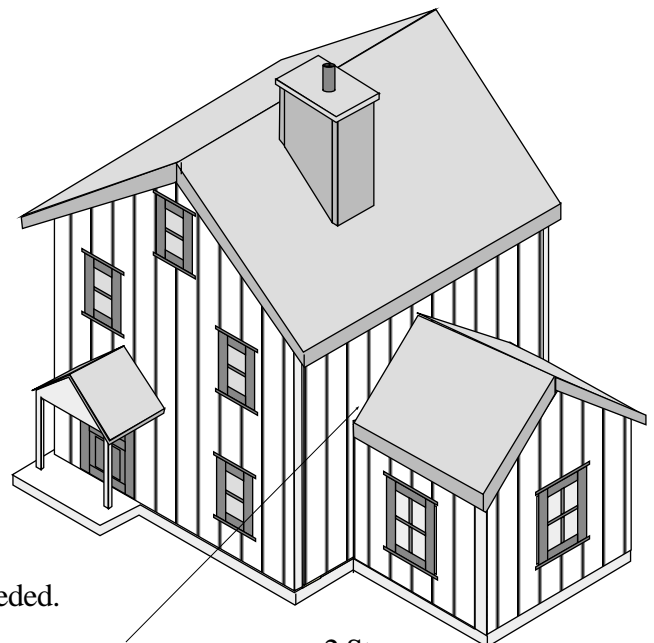

2 Story